



AMC-UTx-M

Modbus RTU Sensor/Transmitter

USER MANUAL



3550435A

Copyright © 2026 AMC

The Armstrong Monitoring Corporation

215 Colonnade Road South, Ottawa, Ontario, Canada K2E 7K3

Tel: (613) 225 9531 • Fax: (613) 225 6965 • Canada & U.S. Toll Free: 1 (800) 465 5777

Email: support@armstrongmonitoring.com • Website: www.armstrongmonitoring.com



Table of Contents

1.	General Information	8
1.1	Warranty	8
1.2	Liability	8
1.3	Product Return	8
1.4	Contact Information	8
1.5	Modifications and Substitutions.....	9
1.6	Glossary.....	9
2.	Product Specifications	10
2.1	AMC-UTx-M Transmitter Specifications.....	10
2.2	Transmitter Order Numbers	10
2.3	Sensor Module	11
2.3.1	Carbon Monoxide	11
2.3.2	Carbon Monoxide/Nitrogen Dioxide.....	11
2.3.3	Nitrogen Dioxide	12
2.3.4	Methane.....	12
2.3.5	Propane	13
2.3.6	Hydrogen.....	13
2.3.7	Oxygen	14
2.4	Product Description.....	15
2.5	External View	16
2.6	Internal View	17
2.7	Accessories	18
2.7.1	UTx Calibration Kit	18
3.	Installation.....	19
3.1	Overview	19
3.2	Transmitter Mounting.....	19
3.3	Accessory Mounting	22
3.3.1	Weathershield	22
3.3.2	Vandal Guard.....	23
3.3.3	Pole Mounting Brackets.....	24



3.4 Wiring	25
3.4.1 Power	27
3.4.2 Communication	27
3.4.2.1 End of Line (EOL) Setting	28
4. Operation	31
4.1 Overview	31
4.2 Status LEDs.....	31
4.2.1 Start Up.....	31
4.2.2 Network Status	31
4.2.3 Faults	32
4.2.4 Alarms	33
4.2.5 Calibration	33
4.2.6 Miscellaneous	34
4.3 Menu Overview.....	34
4.3.1 Normal Operation.....	34
4.3.2 Failed Sensor	35
4.3.3 Warning/Alarm Indication.....	36
4.3.4 Fault Indication	37
4.3.5 Detailed Sensor Screen	38
4.3.6 Detailed Status Screen	38
4.3.7 Quick Info Screen	39
4.3.8 Password Entry	39
4.3.9 Main Service Menu	41
4.3.9.1 Service Menu Timeout.....	41
4.3.9.2 Service Menu Overview	41
4.3.10. External Sensor Service Menu	42
4.3.10.1 External Sensor Service Menu Overview.....	42
4.3.10.2 Analog Sub-Menu	42
4.3.10.3 Sensor Sub-Menu	44
4.3.10.4 Gas Label	45
4.3.10.5 Engineering Units.....	45



4.3.10.7 Simulation Of Gas Levels (External Sensors).....	46
4.3.10.8 Override	46
4.3.10.9 Sim Enable	47
4.3.10.10. Sim Gas	48
4.3.11 Transmitter Service Menu.....	48
4.3.11.1 Modbus Settings	50
4.3.11.2 Transmitter Sensors Settings	50
4.3.11.3 Sensor Alarm Configuration Sub-Menu	51
4.3.11.4 Transmitter Alarms Settings	55
4.3.11.5 Transmitter Relay Settings	60
4.3.11.6 Outputs	62
4.3.11.7 RTC Date & Time	65
4.3.12 Calibration	66
4.3.12.1 Required Equipment; EZ Cal Exchange Program	66
4.3.12.2 Required Equipment; On-Site Sensor Module Calibration.....	66
4.3.12.3 Pre Bump Test.....	67
4.3.12.4 Calibration Procedure – Menu	67
4.3.12.5 Calibration Procedure – Routine	70
5. Maintenance	72
5.1 General.....	72
5.2 Scheduled Calibration	72
5.3 Sensor Module	72
5.3.1 Sensor Module Replacement	72
5.3.1.1 Remove Sensor Module	73
5.3.1.2 Install Sensor Module	74
5.4 Verification of Operation	75
5.4.1 Simulation of Gas Levels.....	75
5.4.2 LED/Relay Activation Test.....	76
6. Modbus	77
6.1 Register Set.....	77
6.2 Analog Config.....	84



- 6.3 Relay control85
- 6.4 Change Notification System.....85
- 7. Troubleshooting 87**
 - 7.1 Symptoms and Corrective Actions87
- 8. Sensor Module Default Settings..... 90**
 - 8.1 Default Alarm Settings90
 - 8.2 Default Sensor Module Settings91
- 9. Menu Flow Diagrams 92**
 - 9.1 Main Screen / Password Flow92
 - 9.2 UTx Service Menu93
 - 9.3 Modbus Menu95
 - 9.4 Sensor Service Menu96
 - 9.5 Sensor Configuration Menu.....98
 - 9.6 Alarm Menu.....99
- 10. Revision History 100**
 - 10.1 Document Revision History.....100



List of Figures

Figure 3-1: Example of Connections to AMC-1DB1-3XXX Digital Monitor.....	26
Figure 3-2: Disconnecting BusPower Module	28
Figure 3-3: Removing BusPower Module	29
Figure 3-4: EOL Switch	29
Figure 3-5: Replacing BusPower Module	30
Figure 5-1: Disconnect Sensor Module.....	73
Figure 5-2: Removing Sensor Module from Lid.....	73
Figure 5-3: Installing Sensor Module	74
Figure 5-4: Attaching Cable to Sensor Module	74
Figure 9-1: Main Screen / Password Flow Diagram	92
Figure 9-2: UTx Service Menu Flow Diagram (a)	93
Figure 9-3: UTx Service Menu Flow Diagram (b)	94
Figure 9-4: Modbus Menu Flow Diagram	95
Figure 9-5: Sensor Service Menu Flow Diagram (a)	96
Figure 9-6: Sensor Service Menu Flow Diagram (b)	97
Figure 9-7: Sensor Configuration Menu Flow Diagram.....	98
Figure 9-8: Alarm Menu Flow Diagram.....	99



List of Tables

Table 4-1: Status LEDs (Start Up)	31
Table 4-2: Status LEDs (Network Status)	31
Table 4-3: Status LEDs (Faults)	32
Table 4-4: Status LEDs (Alarms).....	33
Table 4-5: Status LEDs (Calibration).....	33
Table 4-6: Status LEDs (Miscellaneous)	34
Table 4-7: Service Menu Options.....	41
Table 4-8: External Sensor Menu Options	42
Table 4-9: Analog Sub-Menu Options	43
Table 4-10: Sensor Sub-Menu Options	44
Table 4-11: Engineering Unit Options	46
Table 4-12: External Override Sub-Menu Options.....	46
Table 4-13: Transmitter Service Menu Options.....	48
Table 4-14: Sensor Module Configuration Menu.....	51
Table 4-15: Sensor Alarm Configuration	51
Table 4-16: Calibration Frequency Configuration	54
Table 4-17: Transmitter Alarm Settings	55
Table 4-18: Transmitter Alarm Sub-Menu Settings	55
Table 4-19: Alarm Input Options.....	58
Table 4-20: Alarm Setpoint Options	58
Table 4-21: Alarm Type Options	58
Table 4-22: Outputs Sub-Menu	62
Table 7-1: Troubleshooting Table.....	87
Table 8-1: Default Alarm Settings	90
Table 8-2: Default Sensor Module Settings	91



1. General Information

1.1 Warranty

This product is warranted against defects in material and workmanship for a period of two years from date of delivery. Maintenance items are not warranted. During the warranty period, *The Armstrong Monitoring Corporation* will repair or replace components that prove to be defective in the opinion of AMC. Any equipment deemed to be defective by the user should be returned to *The Armstrong Monitoring Corporation* for evaluation (see product return below). Site visits by Armstrong personnel, to evaluate/repair equipment, are not covered by this warranty unless covered under the site contract. AMC is not liable for auxiliary interfaced equipment, nor for consequential damage. This warranty shall not apply to any product which has been modified in any way, which has been repaired by any other party other than a qualified technician or authorized AMC representative, or when failure is due to misuse or conditions of use.

Note: Extended Warranty and mail in calibration programs are available (please call 1-800-465-5777) or see our contacts page at www.armstrongmonitoring.com

1.2 Liability

All AMC products must be installed and maintained according to instructions. Only qualified personnel should install and maintain the equipment. This product must not be placed in areas with combustible gases reaching 100% LEL (environments prone to explosions).

AMC shall have no liability arising from auxiliary interfaced equipment, for consequential damage, or the installation and operation of this equipment. AMC shall have no liability for labor or freight costs, or any other costs or charges in excess of the amount of the invoice for the products.

THIS WARRANTY IS IN LIEU OF ALL OTHER WARRANTIES, EXPRESSED OR IMPLIED AND SPECIFICALLY THE WARRANTIES OF MERCHANTABILITY AND FITNESS FOR A PARTICULAR PURPOSE. THERE ARE NO WARRANTIES THAT EXTEND BEYOND THE DESCRIPTION ON THE FACE THEREOF.

1.3 Product Return

All products returned for warranty or service should be shipped by prepaid freight and will be accepted only with RMA or repair number issued by AMC.

1.4 Contact Information

For information, please call 1-800-465-5777, visit www.armstrongmonitoring.com or email directly support@armstrongmonitoring.com.



1.5 Modifications and Substitutions

Due to an ongoing development program, AMC reserves the right to substitute components and change specifications at any time without incurring any obligations.

1.6 Glossary

Act Delay	The delay in seconds between the gas concentration reaching an alarm setpoint, and the corresponding alarm level activating.
Alarm	Alarm is an audible, visual, or physical presentation designed to warn the instrument user that a specific level of a dangerous gas/vapor concentration has been reached or exceeded.
Calibration	Calibration is the procedure used to adjust the instrument for proper response.
Calibration Gas	Calibration Gas is a gas of known concentration used in adjusting and testing gas detection equipment to ensure proper function and accurate readings.
Gas Concentration	Gas Concentration can be measured in: <ul style="list-style-type: none">• ppm• %LEL• % Volume
Hysteresis	A user-set difference from an alarm's setpoint prevents frequent alarm activation. Hysteresis solely impacts alarm deactivation, not its activation tied to the setpoint.
LEL	Lower Explosive Limit is the lowest concentration (percentage) of a gas or a vapor in air capable of combusting in the presence of an ignition source (arc, flame, heat).
Min Run	The minimum time in seconds that an alarm state will remain active, even if the gas concentration has returned above/below the setpoint +/- hysteresis (based on a decreasing or increasing alarm type).
ppm	Parts Per Million (1% volume = 10,000ppm)
Percent by Volume	Concentration of gas in a mixture expressed as a percentage of total volume.
Span	The difference between the highest concentration and lowest concentration.
T90	Response Time in seconds to achieve 90% gas concentration reading.
T99	Response Time in seconds to achieve 99% gas concentration reading.
Zero Buffering	Zero buffering is a function of the monitor which forces the gas concentration reading to zero when sensor is exposed to low concentration of a gas. The zero buffer is indicated in the sensor specification.
Zero Gas	Zero gas is gas in which the target gas is not present. The presence of oxygen is required. Clean air is an excellent source for zero calibration. A known gas concentration can be entered during zero calibration.



2. Product Specifications

2.1 AMC-UTx-M Transmitter Specifications

System	
System Warranty Period	2 Years
Power Supply Requirement	24VDC, 40mA
Relays	SPDT, 30VDC, 2A (resistive)
Operating Temperature	-4° to 104° F (-20° to 40° C)
Operating Pressure	0.9 to 1.1 atm
Humidity Range	15 to 90% RH, non-condensing
Signaling	Modbus RTU 9600 Baud, 8bit, Even Parity

2.2 Transmitter Order Numbers

Transmitter Order Number	Description
AMC-UTx-M-91A01-98A01-R-0000	UTx Modbus, 2 Sensor Modules CO 0-100ppm, NO ₂ 0-10ppm, Relay
AMC-UTx-M-91B01-98A01-R-0000	UTx Modbus, 2 Sensor Modules CO 0-300ppm, NO ₂ 0-10ppm, Relay
AMC-UTx-M-VCA01-N-R-0000	UTx Modbus, 1 Dual Sensor Module CO 0-100ppm, NO ₂ 0-10ppm, Relay
AMC-UTx-M-VCB01-N-R-0000	UTx Modbus, 1 Dual Sensor Module CO 0-300ppm, NO ₂ 0-10ppm, Relay
AMC-UTx-M-91A01-N-R-0000	UTx Modbus, 1 Sensor Module CO 0-100ppm, Relay
AMC-UTx-M-91B01-N-R-0000	UTx Modbus, 1 Sensor Module CO 0-300ppm, Relay
AMC-UTx-M-98A01-N-R-0000	UTx Modbus, 1 Sensor Module NO ₂ 0-10ppm, Relay
AMC-UTx-M-60A01-N-R-0000	UTx Modbus, 1 Sensor Module CH ₄ 0-100% LEL, Relay
AMC-UTx-M-61A01-N-R-0000	UTx Modbus, 1 Sensor Module C ₃ H ₈ 0-100% LEL, Relay
AMC-UTx-M-62A01-N-R-0000	UTx Modbus, 1 Sensor Module H ₂ 0-100% LEL, Relay
AMC-UTx-M-70A01-N-R-0000	UTx Modbus, 1 Sensor Module O ₂ 0-25% Vol, Relay



2.3 Sensor Module

2.3.1 Carbon Monoxide

Gas Type	CARBON MONOXIDE (CO)
Sensor Module Order Number	AMC-SM-91A01 (0-100ppm) AMC-SM-91B01 (0-300ppm)
Detection Range	See Above
Operating Temperature	-4° to 104° F (-20° to 40° C)
Sensor Height Above Finished Floor (As part of Digital Transmitter)	4-6 Feet (1.2 – 1.5m)
Sensor Life	Up to 6 Years
Sensor Warranty	3 Years
Zero Buffering of Display	< 5ppm
Calibration Kit Part Number	AMC-C1-FM2
Recommended Calibration Gas	100ppm CO – 91A01 300ppm CO – 91B01
Gas Flow Rate	0.01765 cfm (0.5L/min)

2.3.2 Carbon Monoxide/Nitrogen Dioxide

Gas Type	CARBON MONOXIDE (CO) NITROGEN DIOXIDE (NO ₂)
Sensor Module Order Number	AMC-SM-VCA01
Detection Range	0-100ppm CO 0-10ppm NO ₂
Operating Temperature	-4° to 104° F (-20° to 40° C)
Sensor Height Above Finished Floor (As part of Digital Transmitter)	4-6 Feet (1.2 – 1.5m)
Sensor Life	Up to 2 Years NO ₂ Up to 6 Years CO
Sensor Warranty	2 Years
Zero Buffering of Display	< 5ppm CO < 0.5ppm NO ₂
Calibration Kit Part Number	AMC-C1-FM2
Recommended Calibration Gas	100ppm CO 10ppm NO ₂
Gas Flow Rate	0.01765 cfm (0.5L/min)



2.3.3 Nitrogen Dioxide

Gas Type	NITROGEN DIOXIDE (NO ₂)
Sensor Module Order Number	AMC-SM-98A01
Detection Range	0-10ppm
Operating Temperature	-4° to 104° F (-20° to 40° C)
Sensor Height Above Finished Floor (As part of Digital Transmitter)	4-6 Feet (1.2 – 1.5m)
Sensor Life	Up to 2 Years
Sensor Warranty	1 Year
Zero Buffering of Display	< 0.5ppm NO ₂
Calibration Kit Part Number	AMC-C1-FM2
Recommended Calibration Gas	10ppm NO ₂
Gas Flow Rate	0.01765 cfm (0.5L/min)

2.3.4 Methane

Gas Type	METHANE (CH ₄)
Sensor Module Order Number	AMC-SM-60A01
Detection Range	0-100% LEL
Operating Temperature	-4° to 104° F (-20° to 40° C)
Sensor Height Above Finished Floor (As part of Digital Transmitter)	Place 18 inches (20.32 cm) down from the top of the ceiling. Do not mount directly to ceiling.
Sensor Life	> 2 Years
Sensor Warranty	1 Year
Zero Buffering of Display	5% LEL
Calibration Kit Part Number	AMC-C1-FM2
Recommended Calibration Gas	50% LEL CH ₄
Gas Flow Rate	0.01765 cfm (0.5L/min)



2.3.5 Propane

Gas Type	PROPANE (C ₃ H ₈)
Sensor Module Order Number	AMC-SM-61A01
Detection Range	0-100% LEL
Operating Temperature	-4° to 104° F (-20° to 40° C)
Sensor Height Above Finished Floor (As part of Digital Transmitter)	Place 18 inches (20.32 cm) up from the bottom of the floor. Do not mount directly to floor.
Sensor Life	> 2 Years
Sensor Warranty	1 Year
Zero Buffering of Display	5% LEL
Calibration Kit Part Number	AMC-C1-FM2
Recommended Calibration Gas	50% LEL C ₃ H ₈
Gas Flow Rate	0.01765 cfm (0.5L/min)

2.3.6 Hydrogen

Gas Type	HYDROGEN (H ₂)
Sensor Module Order Number	AMC-SM-62A01
Detection Range	0-100% LEL
Operating Temperature	-4° to 104° F (-20° to 40° C)
Sensor Height Above Finished Floor (As part of Digital Transmitter)	Place 18 inches (20.32 cm) down from the top of the ceiling. Do not mount directly to ceiling.
Sensor Life	> 2 Years
Sensor Warranty	1 Year
Zero Buffering of Display	5% LEL
Calibration Kit Part Number	AMC-C1-FM2
Recommended Calibration Gas	50% LEL H ₂
Gas Flow Rate	0.01765 cfm (0.5L/min)



2.3.7 Oxygen

Gas Type	OXYGEN (O ₂)
Sensor Module Order Number	AMC-SM-70A01
Detection Range	0-25% Vol
Operating Temperature	-4° to 104° F (-20° to 40° C)
Sensor Height Above Finished Floor (As part of Digital Transmitter)	4-6 Feet (1.2 – 1.5m)
Sensor Life	Up to 2 Years
Sensor Warranty	2 Years
Zero Buffering of Display	< 1.25% Vol
Calibration Kit Part Number	AMC-C1-FM2
Recommended Calibration Gas	Pure Nitrogen
Gas Flow Rate	0.01765 cfm (0.5L/min)

2.4 Product Description



The AMC-UTx Digital Transmitter is designed to provide continuous, reliable monitoring of ambient air for target gas(es) via onboard sensor modules.

The transmitter provides a digital representation of the gas concentration detected; this information is both displayed locally (via OLED) and sent to the respective Monitor upstream over RS-485 using MODBUS/RTU. Plug-and-play modular architecture accommodates; hot-commissioning and field replaceable Sensor Modules (eligible for the EZ-CAL exchange program).

In addition, each transmitter features alarm/system status indicators, audible feedback, an on-board relay and colour-coded connection terminal blocks, as listed and described herein.

2.5 External View

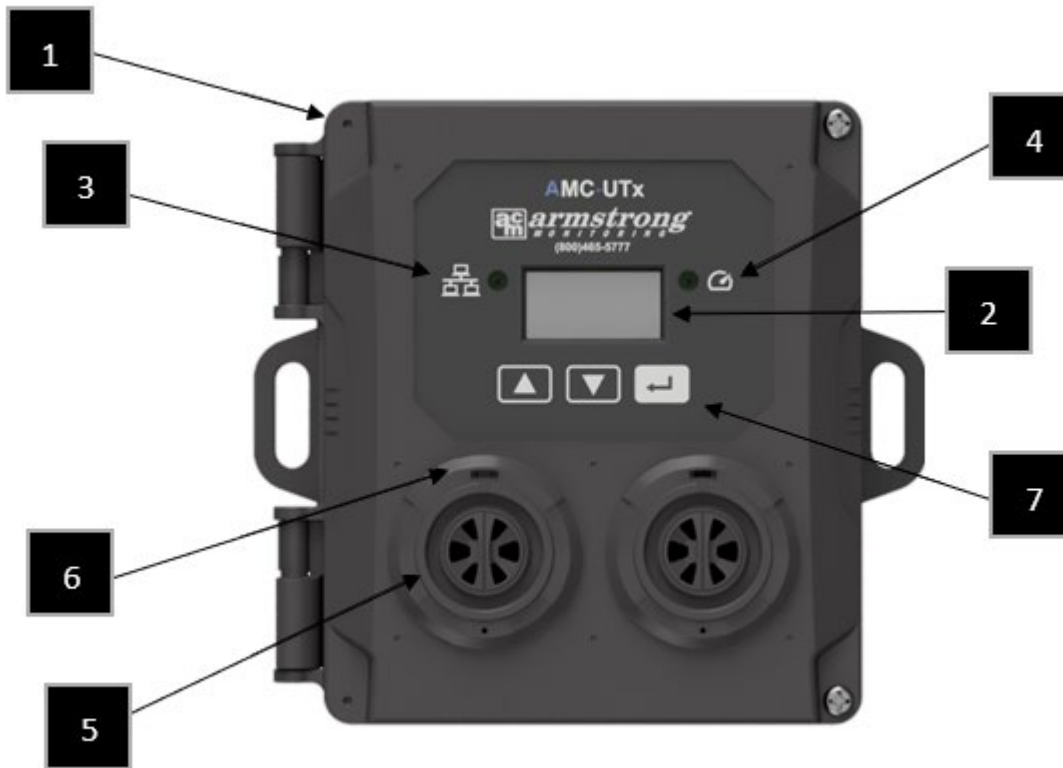

1	Enclosure Lid	Enclosure and Lid Assembly, PC-ABS blend, 5.45" L x 6.14" W (140mm x 156mm) Wall Mount with two mount points. Option for Pole Mount.
2	Display	Displays Gas Concentration & Status Information.
3	Network Status LED	Indicates Status of Network Interface and will show whether or not the UTx has established / maintained Network Communication.
4	Alarm Status LED	The Sensor Status LED will show the same error code that is being communicated by the Sensor Module(s) or display the highest priority error (if multiple error codes are being communicated to it by the Sensor Module(s)).
5	Sensor Module	This inlet allows target gas to flow into the sensor. The inlet is also used for gas calibration.
6	Sensor Module LED	Sensor Module LEDs will show the status of the sensor element within the Sensor Module, or the status of the Sensor Module itself.
7	Menu Buttons	Momentary Pushbuttons for user interface.

2.6 Internal View



1	Bus Power Connectors	The two 12 pin connectors on the BusPower Module provide all interfaces to the UTx-M-xx-400.
2	EOL LED	This LED will be illuminated GREEN if the UTx is configured as EOL.
3	Sensor Module Connections	Connectors on the Sensor Module(s) are used to connect between Sensor Modules and between Sensor Module 1 and the Transmitter.

2.7 Accessories

Accessory Description	Order Code	Notes
Weathershield for AMC Transmitters	AMC-WS00-SL	Refer to Weathershield section for mounting instructions.
Vandal Guard Universal Fit	AMC-VG-XL	Refer to Vandal Guard section for mounting instructions.
Pole Mounting Brackets	Included with Each Transmitter	Refer to Pole Mounting Brackets section for mounting instructions.
Calibration Kit	AMC-C1-FM2	Refer to UTx Calibration Kit section for details.
Calibration Adapter	AMC-FM2	Refer to UTx Calibration Kit section for details.

2.7.1 UTx Calibration Kit

The UTx Calibration Kit, as shown below, consists of the AMC-FM2 Calibration Adaptor that secures the calibration gas hose to the front of the UTx Sensor Module along with a hose to connect to the calibration gas cylinder regulator.





3. Installation

3.1 Overview

NOTE: All Armstrong Monitoring systems must be installed and maintained according to instructions to assure proper operation. Only qualified personnel should install and maintain the equipment. For exchange, re-calibration or extended warranty programs information please call 1-800-465-5777 or through contacts at www.armstrongmonitoring.com

The installation of the AMC-UTx-M Digital Transmitter is very important as the operational quality is a direct result of the quality of the installation. The following sections provide guidelines for installation, location and mounting, wiring, and cable selection.

3.2 Transmitter Mounting

Mount the AMC-UTx-M Digital Transmitter on a solid, non-vibrating surface or structure. Mount in an area where the ambient concentration of gas is not directly affected by the presence of a clean air supply, ventilation systems, or blockage by surrounding articles. Locate away from sources of interference gases. If the main objective is the fastest possible leak detection, mount the sensor near the potential leak sources. Please refer to local codes for installation information. The installer is required to provide any mounting hardware that may be required.

In order to mount the AMC-UTx-M:

1. Remove cover.
2. Mount housing using defined mounting holes. See the **Enclosure Mounting** figure and **Enclosure Pole Mounting** figure.
3. Drill holes for conduit and then install conduit. See WARNING below.
4. Re-attach cover and bracket.



WARNING:

The transmitter should not be placed near cleaning products/solvents, particularly ones that contain alcohol. This can permanently damage sensor elements or cause negative output values.

Conduit should enter the housing from the bottom to ensure best protection against ingress of condensation.

Conduit entry from the top or back of the housing is Not Recommended. Any water damage related to conduit entry from the top or back will not be covered under warranty.

Qualified personnel should perform the installation according to all applicable electrical codes, regulations and safety standards. Ensure correct cabling practices are implemented.

Mount all equipment away from any source of electro-magnetic interference (EMI) or radio frequency interference (RFI) such as power transformers, electric motors, etc.

Equipment must be positioned such that the change of water damage is minimized; Example away from fire suppression sprinkler heads, away from wet or damp locations where there would be risk of water damage.

Ensure a balanced layout of sensors to cover the intended area. Refer to the **Accessory Mounting** section. If the transmitter is to be mounted on a pole, in a location where water spraying or splashing could be an issue, or in locations where a vandal guard is required.

NOTE: Mount enclosure as shown in the below **Enclosure Mounting** figure. This will ensure correct orientation.

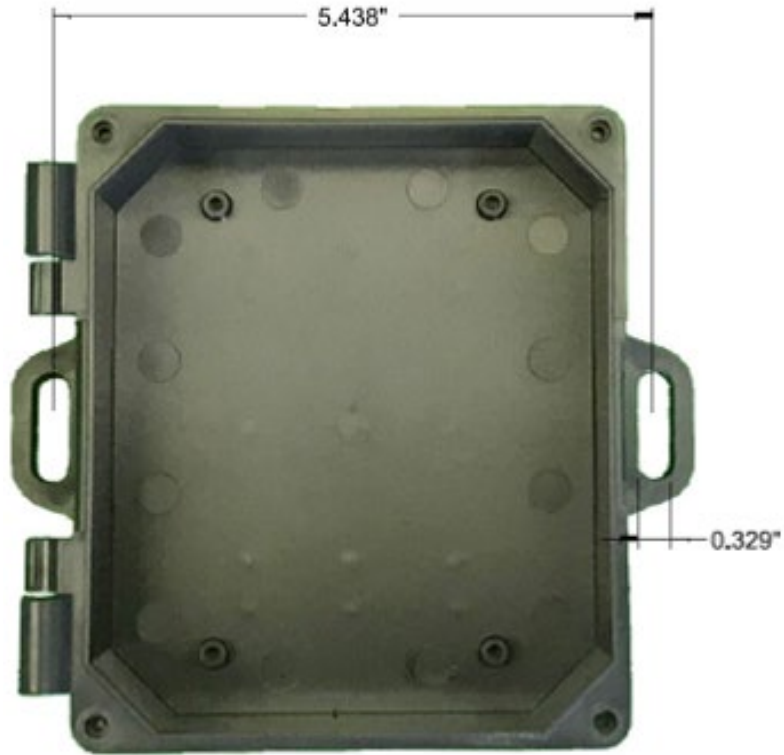

3.3 Accessory Mounting

3.3.1 Weathershield

NOTE: The Weathershield assembly is compatible with both wall and pole mounting configurations. To install the Weathershield follow these steps:

1. Place the Bracket Assembly behind the Transmitter.



2. Mount the Bracket Assembly, and Transmitter to the wall or pole. (Mounting Screws NOT Included).



3. Place the Weathershield over the bracket. The side screws fit into the slots. Tighten the screws to hold the Weathershield in place.



3.3.2 Vandal Guard

NOTE: The Vandal Guard assembly is only compatible with wall mounting configurations. To install the Vandal Guard, follow these steps.

1. Mount the Transmitter to the wall. (Mounting Screws not included).
2. Connect all wiring to the Transmitter.
3. Mount the Vandal Guard to the wall. (Mounting Screws NOT Included). **NOTE:** Mounting hole is 0.25 inch (6.3mm) diameter and are on an 8.0" W x 4.38" H (200mm x 110mm) pattern.

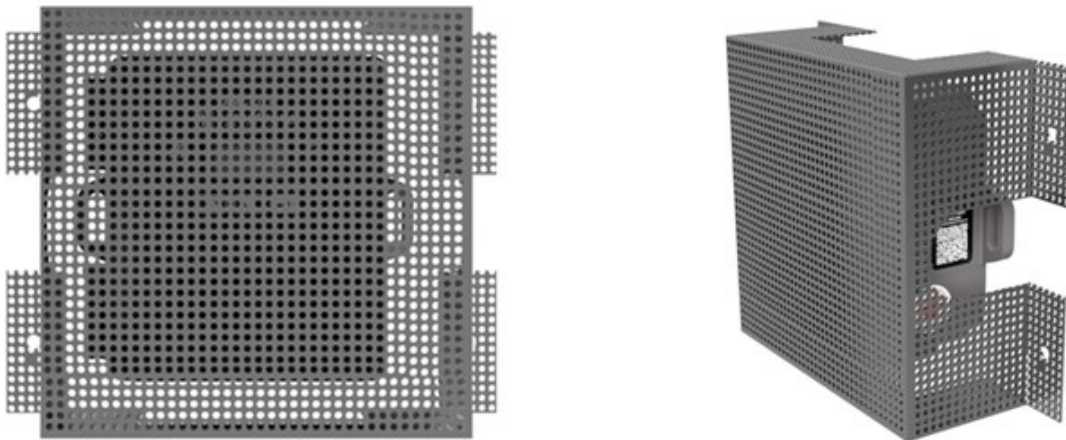

3.3.3 Pole Mounting Brackets

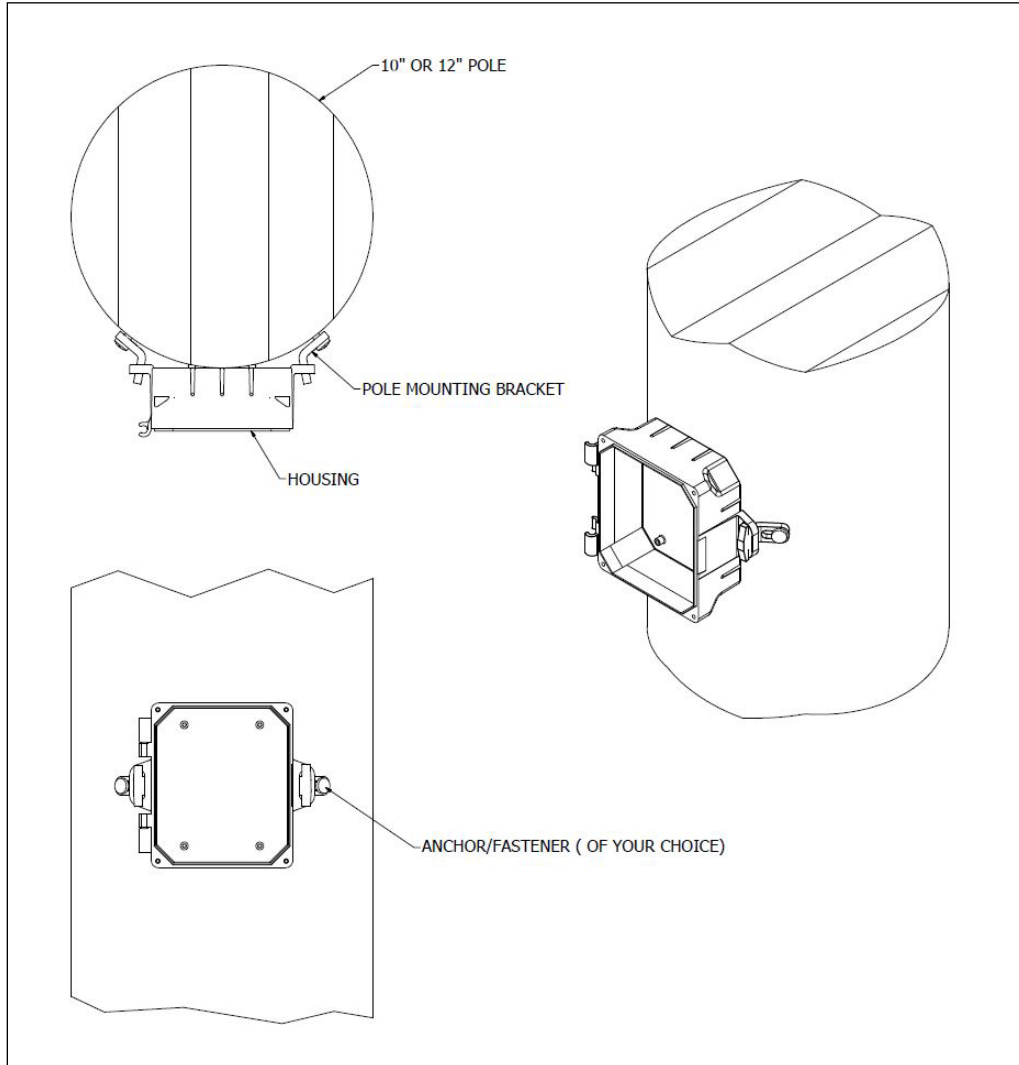



3.4 Wiring

1. The AMC-UTx Digital Transmitter employs a four-wire plus shield system which has two main wiring systems: the monitor communication (two wires) and power supply wiring (two wires).
2. A two conductor, 20-24 AWG shielded cable is recommended to connect the RS-485 signals from the AMC-UTx Digital Transmitter to the monitor. The cable characteristics required are an importance of 120 ohms and a low capacitance 13pf/ft conductor to conductor and 23pf/ft conductor to shield.
3. For best signal transmission and maximum noise rejection, it is recommended to connect the cable shields to chassis ground at the monitor. The shield is wired to the T-connector at each transmitter, to maintain end-to-end continuity.
4. A two conductor 16-24 AWG cable is recommended to connect the power from the Transmitter to the DC power source. The selected cable must meet application and/or local regulatory requirements.
5. Wire gauge will affect maximum distance between transmitters and power supply. Thicker wire is required for greater distance.
6. For wiring taps the derivations must be short (never more than 65ft (20m)). If multiple taps are used with n derivations, the sum of all taps must not exceed a maximum of 130ft (40m). See the below **Connection to an AMC-1DB1-3XXXX Digital Monitor** figure for an example of connections to an AMC-1DB1-3XXXX Digital Monitor.
7. Route cabling away from AC power cabling and any source of electro-magnetic interference (EMI) or radio frequency interference (RFI) such as power transformers, electric motors, etc.
8. EMT (Electrical Metal Tube) conduit also adds an added degree of electrical shielding against EMI (Electro-Magnetic Interference) from devices such as RF (i.e. radio) sources.
9. Cabling should enter the sensors and monitors from the bottom to ensure best protection against water damage.
10. Ensure that there are no short or open circuits in the sensor cabling.
11. Verify that the communication cabling is voltage free prior to connecting the cabling to either the AMC-UTx Digital Transmitter or the monitor.
12. All Shield wires must be covered with insulating material to prevent them from shorting with other wires.

The next pages are electrical wiring diagram examples for an application where the monitor supplies both power and communication.

Warning

Installing monitor communication without shield will produce unreliable system wide failure. Armstrong Monitoring Corporation will not support this type of installation.

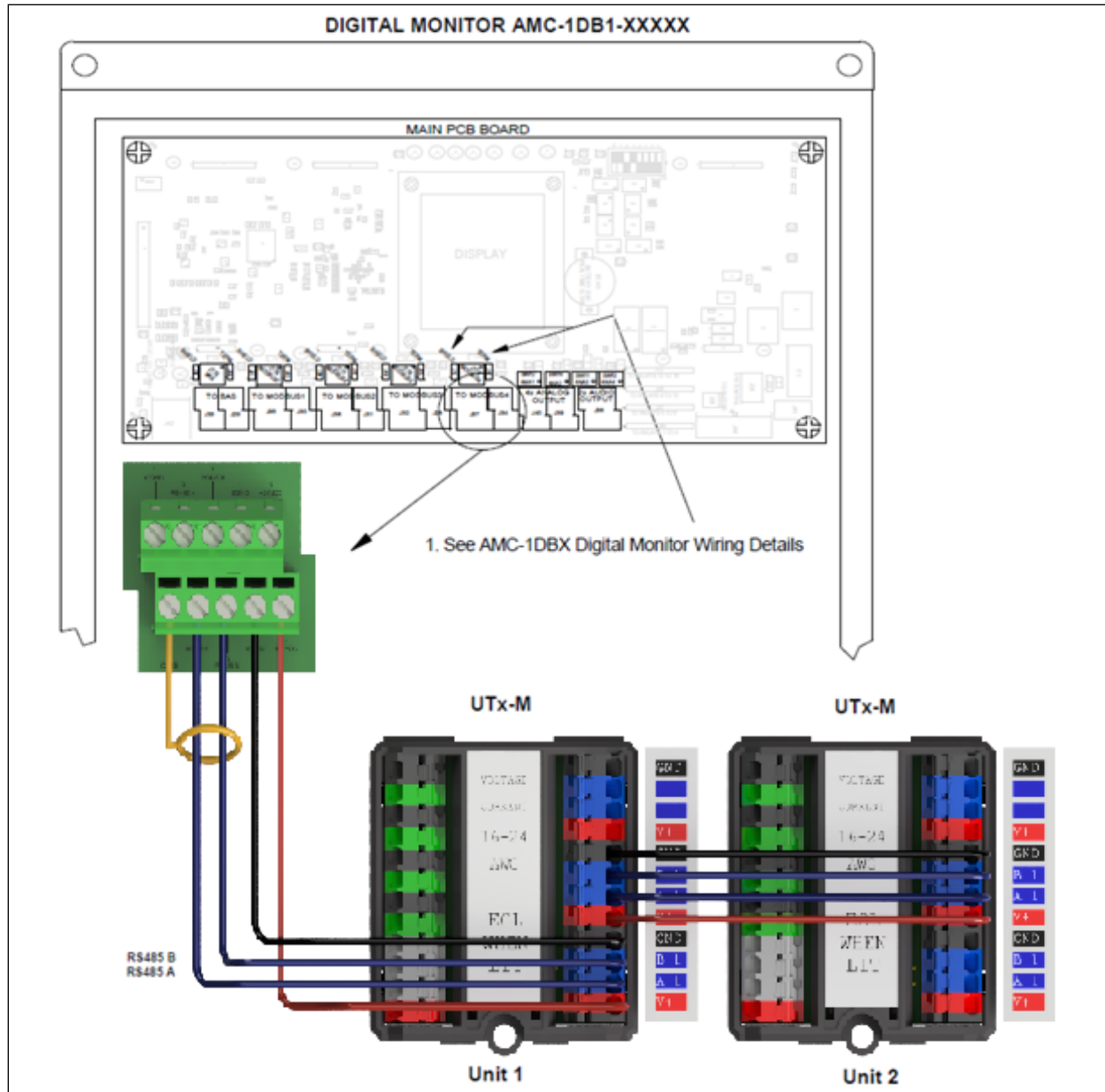

Figure 3-1: Example of Connections to AMC-1DB1-3XXX Digital Monitor

Warning

Care must be taken when connecting services to Power and Communication Connector. Mixing power and communication connections can cause permanent damage. Consistent polarity of RS-485 wire is required throughout network for proper system operation.



3.4.1 Power

The UTx is 24VDC powered and has a minimum UTx-M operating voltage of 12 Volts. The table below indicates the maximum number of usable units for various wire gauges and distances between units to ensure properly operating voltage. Using lower number of units for the gauge and distance will allow UTx-M-400 unit to operate correctly.

Please consult with Armstrong Monitoring for maximum number of usable units for other gauges or greater distances.

Average Distance Between Units	75ft (22m)		150ft (45m)		200ft (61m)	
	16AWG	18AWG	16AWG	18AWG	16AWG	18AWG
Number of Units	27	21	19	15	16	13
Total Current	1.49A	1.16A	1.05A	0.83A	0.88A	0.72A

Caution:

Care must be taken when installing to ensure that all UTx-M-400 units are connected with the same power supply polarity across the network. Digital Transmitter + should be connect to +24VDC power terminal at monitor and Digital Transmitter - should be connected to SGND power terminal at monitor.

3.4.2 Communication

The total communication cable length for a network segment should not exceed 3280ft (1000m) without the use of repeaters.

There is a 32-unit load (UL) transmitter limit per RS-485 bus segment determined by ANSI/TIA/EIA-485-A-1998 standard. The AMC-1DBx Digital Monitor uses one RS-485-unit load, so only 31 additional RS-485-unit loads can be driven on each MODBUS Network Segment. Note that each device and the repeaters use a UL on each input.

The AMC-1DMB-PS-R Repeater is required to expand beyond this 32 UL limit configuration limit per MODBUS and requires a unit load itself.

Caution:

Care must be taken when installing to ensure that all Digital Transmitters are connected with the same Modbus polarity across the network. Digital Monitor RS-485A should be connected to the UTx-M A1 terminal and Digital Monitor RS-485B should be connected to the B1 terminal.

Note:

When using an AMC-UTx-M-400 with two MODBUS addresses, only one UL will be required by the AMC-1DBx Digital Monitor.

Typically, the drop out voltage will become an issue on long lengths before the maximum of 31 RS-485 unit loads are connected.

3.4.2.1 End of Line (EOL) Setting

EOL termination is required for the last unit of the bus to ensure robust communication. Without this termination reflections of far end signal can add or subtract to the resulting signal waveform and can cause data corruption.

Note if EOL is set to ON the EOL LED will be lit green when the UTx is powered up. The EOL LED is located on the rear of the UTx Lid.

To change EOL settings on the UTx, you must:

- Remove Power
- Open Lid
- Disconnect BusPower Module using a Phillips Screwdriver as shown below.

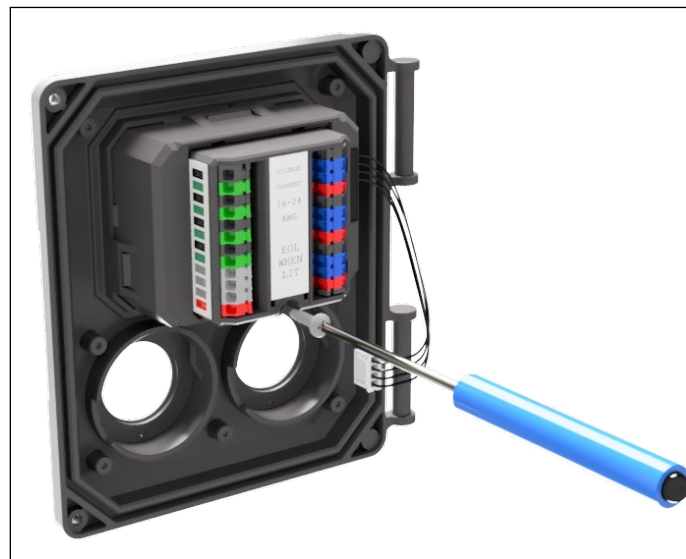

Figure 3-2: Disconnecting BusPower Module

Disconnect BusPower Module from the Lid Assembly as shown below:



Figure 3-3: Removing BusPower Module

Change EOL Setting Switch:



Figure 3-4: EOL Switch

Attach the BusPower Module to the UTx Lid Assembly. Place the top forks in first, then clip the module in place. This can be performed with power on.



Figure 3-5: Replacing BusPower Module

4. Operation

4.1 Overview

This section describes how the functionalities of the Modbus Digital Transmitter are operated and performed. Please consult the Operation and Initial Configuration sections below before attempting to operate the Digital Transmitter.

4.2 Status LEDs

Refer to the **Product Description** section for LED locations and descriptions. During operation the LEDs will display the following configurations:

4.2.1 Start Up

Table 4-1: Status LEDs (Start Up)

LED States	Network LED	Alarm Status LED	Sensor Module LED	Display Screen Message
Initialization and Discovery of Sensor Modules (after UTx is powered up).	OFF	Solid WHITE	Solid WHITE	AMC Splash Screen
Sensor Warm-up	Flashing GREEN (1 sec cycle)	Solid WHITE	Solid WHITE	Main Info Screen (or blank) No Sensor Gas Readings Shown

4.2.2 Network Status

Table 4-2: Status LEDs (Network Status)

LED States	Network LED	Alarm Status LED	Sensor Module LED	Display Screen Message
No Network Connection	Flashing GREEN (1 sec cycle)			
Network Connection Established	Solid GREEN			
Network Fault (Network Activity Timeout, CRC or Parity Error).	Solid RED			



4.2.3 Faults

Table 4-3: Status LEDs (Faults)

LED States	Network LED	Alarm Status LED	Sensor Module LED	Display Screen Message
Fault 1				
At least one sensor has gone under range (more negative than zero blanking setting).	Flashing GREEN (1 sec cycle)	Solid RED	Solid RED	Gas Bar Indicates "FAULT" For Affected Sensors
Fault 2				
Corrupted Sensor Module Signal Sensor Module Missing Incorrect Sensor Module Found Sensor Module NOT Communicating	Flashing GREEN (1 sec cycle)	Solid RED	Solid WHITE or OFF	Gas Bar Indicates "FAIL" For Affected Sensors



4.2.4 Alarms

Table 4-4: Status LEDs (Alarms)

LED States	Network LED	Alarm Status LED	Sensor Module LED	Display Screen Message
Threshold 1 Reached	Flashing GREEN (1 sec cycle)	Solid YELLOW	Solid YELLOW	Gas Bar Indicates “WARN” For Affected Sensors
Threshold 2 Reached	Flashing GREEN (1 sec cycle)	Solid RED	Solid RED	Gas Bar Indicates “ALARM” For Affected Sensors
Threshold 3 Reached	Flashing GREEN (1 sec cycle)	Solid RED	Solid RED	Gas Bar Indicates “ALARM” For Affected Sensors

4.2.5 Calibration

Table 4-5: Status LEDs (Calibration)

LED States	Network LED	Alarm Status LED	Sensor Module LED	Display Screen Message
Cal Needed	Flashing GREEN (1 sec cycle)		Flashing CYAN and YELLOW (.5 sec cycle)	Not Indicated on Display Screen
In Calibration Mode / Calibration Activity Waiting to Start	Flashing GREEN (1 sec cycle)		Solid CYAN	Calibration Routine Prompts
Calibration Looking for Stable	Flashing GREEN (1 sec cycle)		Flashing CYAN (.5 sec cycle)	Calibration Routine Prompts
Calibration Pass	Flashing GREEN (1 sec cycle)		Flashing CYAN and GREEN (.5 sec cycle)	Calibration Routine Prompts
Calibration Fail	Flashing GREEN (1 sec cycle)		Flashing CYAN and RED (.5 sec cycle)	Calibration Routine Prompts

4.2.6 Miscellaneous

Table 4-6: Status LEDs (Miscellaneous)

LED States	Network LED	Alarm Status LED	Sensor Module LED	Display Screen Message
Real-Time Clock (RTC) Disabled or Uninitialized	Flashing GREEN (1 sec cycle)	Solid MAGENTA		Not Indicated on Display Screen
Low RTC Battery	Flashing GREEN (1 sec cycle)	Flashing MAGENTA (1 sec cycle)		Not Indicated on Display Screen

4.3 Menu Overview

Note that a **Menu Flow Chart** is available further in this manual. The menu images and menu flow diagrams in this manual represent gas types with labels such as “GAS1”, “GAS2”, etc. These are mapped to specific gases based on the customer order.

4.3.1 Normal Operation

Upon startup, a brief splash screen is shown on the display which includes the Armstrong Monitoring Corp’s logo and the current version of the UTx firmware. After a couple of seconds, the display will update to show the main info screen (see below). NOTE: The bar graphs indicating gas concentration are not visible initially while the sensor modules are warming up. The warm-up period will be shown in the details section for the selected sensor until the warm-up period expires. NOTE: Factory configurations define a warm-up default value that prevents false alarms while sensors are warming up. This value may be viewed during warm-up through the detailed sensor screen section.

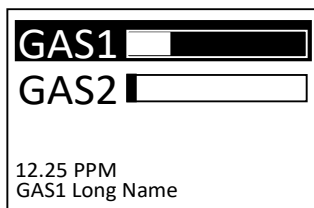

← Highlighted background indicates which sensor is currently selected

← Details pertaining to the selected sensor (its current value and long name)

As shown above, two sensors are currently attached to the transmitter. Only one sensor can be selected at a time for the purpose of inspecting its details. Use the **UP** and **DOWN** buttons to navigate between each sensor. The following diagram illustrates the main info screen after pressing the **DOWN** button from the previous display. Notice how the details are updated to reflect the newly selected sensor.

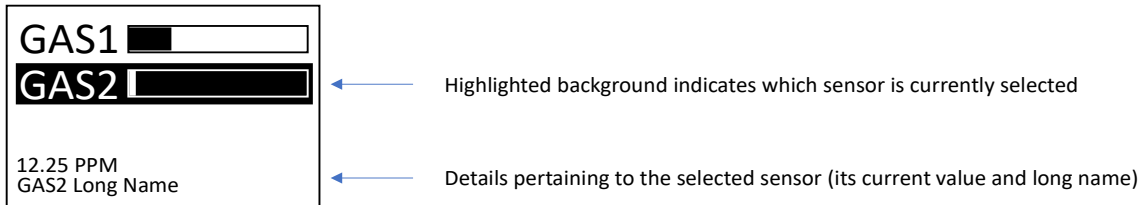

After a programmed timeout period without any button presses, the display will go blank (screen saver mode). To re-enable the display, simply press the **ENTER** button.

4.3.2 Failed Sensor

In the event of a failed sensor, the bar graph is replaced with a large FAIL indication and the detailed description is updated accordingly. If the sensor fails while the display is OFF, the display will immediately turn ON and the failed sensor will be selected by default. In addition, the FAIL indication will toggle between normal and inverse 'white space' mode at a rate of once per second as shown below.

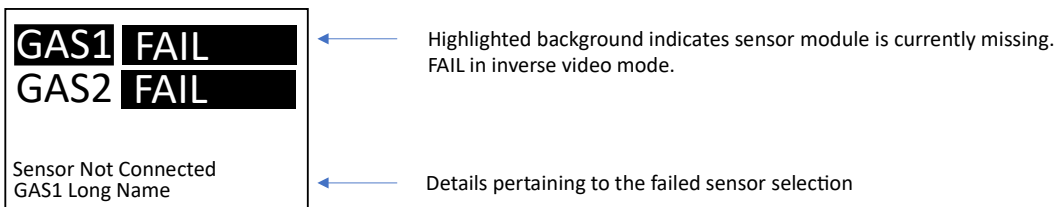
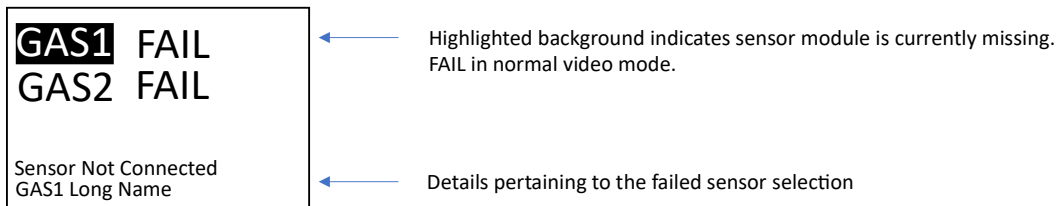

If the failure condition is resolved, the main display for the failed sensor will resume normal operation by indicating the sensor reading via bar graph.

4.3.3 Warning/Alarm Indication

When a warning or an alarm occurs, the bar graph is replaced with a large WARN indication for warnings or a large ALARM for alarms. If the sensor enters a warning or alarm state while the display is OFF, the display will immediately turn ON and the sensor responsible for the warning/alarm will be selected by default. Like the FAIL indication, the WARN/ALARM indication will toggle between normal and inverse 'white space' mode at a rate of once per second as shown below.

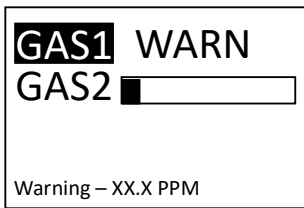

Highlighted background indicates which sensor is currently in a warning state. WARN in normal video mode.

Details pertaining to the sensor

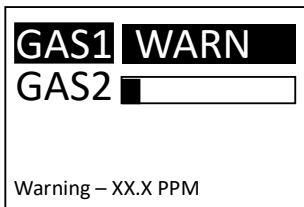

Highlighted background indicates which sensor is currently in a warning state. WARN in inverse video mode.

Details pertaining to the sensor

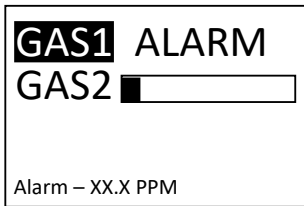

Highlighted background indicates which sensor is currently in alarm. ALARM in normal video mode.

Details pertaining to the selected sensor which is currently in alarm. The current sensor reading is shown.

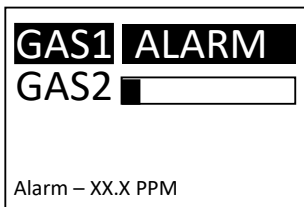

Highlighted background indicates which sensor is currently in alarm. ALARM in inverse video mode.

Details pertaining to the selected sensor which is currently in alarm. The current sensor reading is shown.

For units configured at factory to use latched alarms, when the alarm condition is cleared the display will indicate that the relays are latched until cleared by the user by pressing the **ENTER** button to release the latching condition.



Highlighted background indicates which sensor is currently selected with latched relays. LATCH in normal video mode.

Details pertaining to the selected sensor which currently has its relays in Latched mode. The current sensor reading is shown with an instruction to press the **ENTER** button to release the relays from their active state.

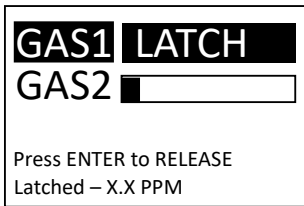

Highlighted background indicates which sensor is currently selected with latched relays. LATCH in inverse video mode.

Details pertaining to the selected sensor which currently has its relays in Latched mode. The current sensor reading is shown with an instruction to press the **ENTER** button to release the relays from their active state.

4.3.4 Fault Indication

The following two menu images show a fault condition in normal and inverse video modes.

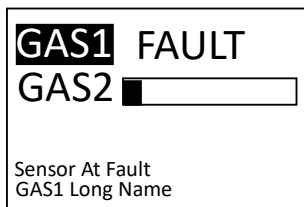

Highlighted background indicates which sensor is currently at fault. FAULT in normal video mode.

Details pertaining to the sensor at fault

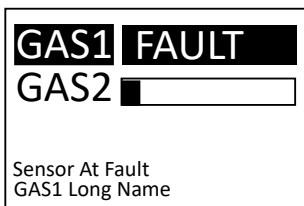

Highlighted background indicates which sensor is currently at fault. FAULT in inverse video mode.

Details pertaining to the sensor at fault

4.3.5 Detailed Sensor Screen

To access the detailed information for each sensor, press and hold the **UP** button until the following screen appears.

S1 : GAS1	←	Label indicates which sensor is currently selected
Current : 2.35	←	Current instantaneous value for the selected sensor
15 min avg : 1.75	←	15 min average value for the selected sensor
8 hour avg : 2.82	←	8 hour average value for the selected sensor
Daily Peak : 3.71	←	Daily peak value for the selected sensor
Sensor 1 of 2	←	Paging info updated as different sensors are selected using UP/DOWN buttons

The detailed sensor screen provides several values for each sensor. Use the **UP** and **DOWN** buttons to page through all the attached sensors. This detailed screen will timeout after 300 seconds if no button is pressed thereby returning the user back to the main info screen. Alternatively, the user can exit the detailed sensor screen on demand by pressing the **ENTER** button to return back to the main info screen.

4.3.6 Detailed Status Screen

To access the detailed status for each sensor, press and hold the **DOWN** button until the following screen appears.

S1 : GAS1	←	Label indicates which sensor is currently selected
Status : Normal	←	Current operational status for the selected sensor
Last Cal : 76 days	←	Number of days since last calibration for the selected sensor
Next Cal : 104 days	←	Number of days until next calibration for the selected sensor
Lifetime : 2126 days	←	Remaining sensor life for the selected sensor
S/N : 1234	←	Serial number for the selected sensor
Sensor 1 of 2	←	Paging info updated as different sensors are selected using UP/DOWN buttons

The detailed status screen provides the complete status for each sensor. Use the **UP** and **DOWN** buttons to page through all the attached sensors. This detailed screen will timeout after 300 seconds if no button is pressed thereby returning the user back to the main info screen. Alternatively, the user can exit the detailed status screen on demand by pressing the **ENTER** button to return to the main info screen.

NOTE: All information dependent on the real-time clock (RTC) such as 'Last Cal' or 'Next Cal' may be incorrect if the RTC is currently disabled or uninitialized (as indicated by a solid magenta on the Alarm Status LED).

Continuing to press **DOWN** after the sensor pages show the firmware version of up to all four modules that are available on the UTx platform. This list also displays the date and time for convenience.

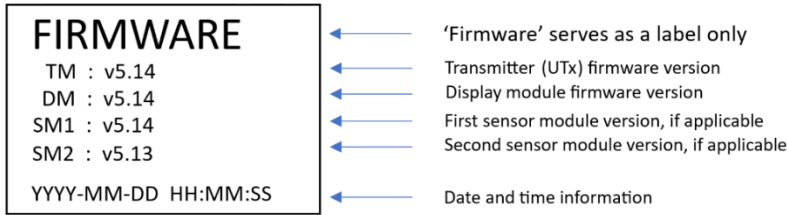

4.3.7 Quick Info Screen

To access the quick info screen, simultaneously press the UP and DOWN buttons from the main screen, until the following screen appears.

The quick info screen provides the transmitters MODBUS address, assembly serial number, bus voltage supplied to unit (V), RTC battery voltage (V), temperature (°C and °F), pressure (Pa), and relative humidity (%RH), or "N/A" if not available.

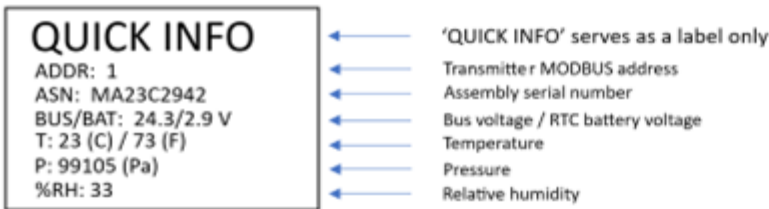

The user can exit the quick info screen by pressing the ENTER button to return to the main info screen.

4.3.8 Password Entry

To access the service menu system, the user needs to press and hold the **ENTER** button until the following password entry screen is displayed.

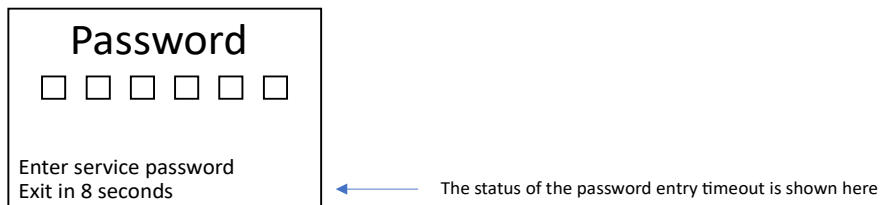

Enter the password using a combination of the **UP**, **DOWN** and **ENTER** buttons. The password is factory set to **UP - DOWN - UP - DOWN - ENTER - ENTER**. As the password is being entered, the display updates with each button press. The diagram below illustrates the state of the password



entry after 3 button presses. The password entry screen will timeout after 10 seconds if no button is pressed thereby returning the user back to the main info screen.

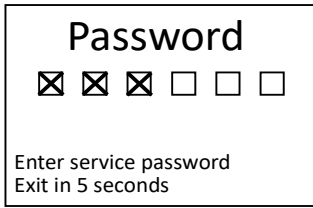

← The status of the password entry timeout is shown here

4.3.9 Main Service Menu

4.3.9.1 Service Menu Timeout

The service menus remain unlocked for a programmed timeout period (set to 5 minutes). Within that period, the service menus can be re-enabled by long pressing the **ENTER** button. If the timeout period is allowed to expire, the password entry screen will appear prior to accessing the service menus. Also, if the service menu is active when a timeout occurs, the service mode is disabled, and the display will go blank (i.e. power saving mode). Lastly, the service menu timeout is reset with each button press while the service menus are active.

4.3.9.2 Service Menu Overview

Once the correct password is entered, the main service menu is displayed as shown in the following diagram.

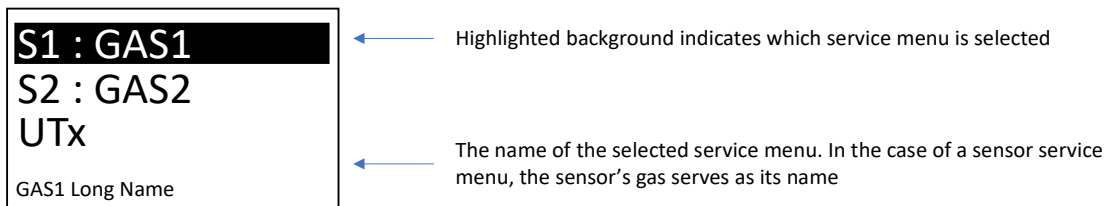

Once again, the **UP** and **DOWN** buttons can be used to navigate the list of service menus. The main service menu provides the menu items listed in the table below:

Table 4-7: Service Menu Options

Menu Item	Description
<Sensor #>: <Gas Label>	Each sensor is included in the service menu indicated by its number and gas label (Ex: S2: CO).
UTx	Access the settings for the transmitter module through the 'UTx' menu item.
Exit	Select this menu item to exit the service menu.

To exit the Service Menu, press **DOWN** repeatedly until the end is reached and Exit is highlighted as shown below.

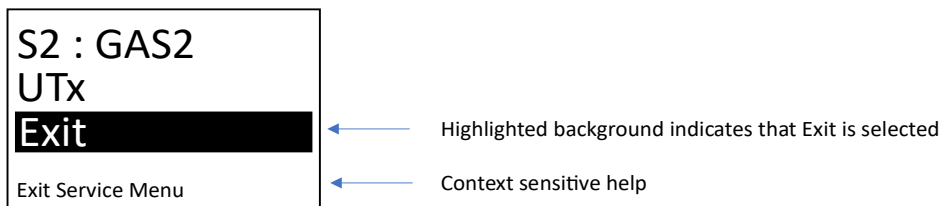

With 'Exit' highlighted (as above), press **ENTER** to exit the service mode and return back to the main info screen as shown below.

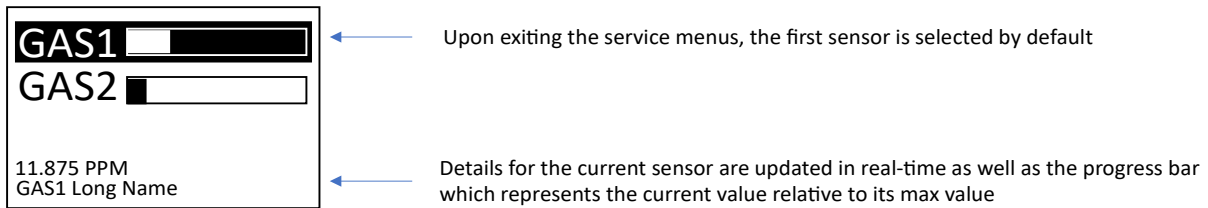

4.3.10 External Sensor Service Menu

NOTE: The Outputs menu (available from the main service menu) is used to provide supplemental configuration options that are applicable to external sensors, beyond those in the External Sensor Service menu.

4.3.10.1 External Sensor Service Menu Overview

If the **ENTER** button is pressed while the service menus are active and an external sensor is currently selected, then the following menu is shown for external sensors. This menu is common to all external sensors, therefore, selecting any external sensor will produce the same menu.

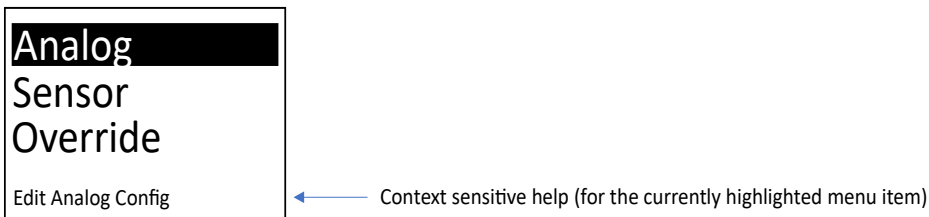

The **UP** and **DOWN** buttons can be used to navigate the list of service menus for the selected sensor. The sensor's service menu provides the following menu items:

Table 4-8: External Sensor Menu Options

Menu Item	Description
Analog	Analog configuration sub-menu for the selected sensor.
Sensor	Sensor configuration sub-menu for the selected sensor.
Override	Override sub-menu for the selected sensor.
Exit	Select this menu to return to the main service menu.

4.3.10.2 Analog Sub-Menu

If 'Analog' configuration sub-menu is activated from the sensor's service menu when an external sensor is selected, then the display will be updated to show the following sub-menu.

- ← Activate this menu item to edit the fault threshold for voltage mode input
- ← Activate this menu item to edit the fault threshold for current mode input
- ← Highlighted background indicates that Exit is selected
- ← Context sensitive help (for the currently highlighted menu item)

The **UP** and **DOWN** buttons can be used to navigate the list of analog configuration options for the selected external sensor. The analog configuration sub-menu is defined in the below table:

Table 4-9: Analog Sub-Menu Options

Menu Item	Description
Fault (V)	Activate this menu item to edit the fault threshold (in V) for voltage mode input.
Fault (mA)	Activate this menu item to edit the fault threshold (in mA) for current mode input.
Exit	Select this menu item to return to the sensor’s service menu. The ‘Analog’ sub-menu will be selected when the sensor’s service menu appears.

If ‘Fault (V)’ is activated from the ‘Analog’ configuration sub-menu, then the display will be updated to show the following editing screen.

- ← ‘Fault (V)’ serves as a label only.
- ← Edit the voltage fault threshold value one digit at a time using the UP/DOWN buttons. Press ENTER to advance the cursor to the next digit. Press ENTER when the last digit is highlighted to save the value.
- ← Context sensitive help (for the currently highlighted menu item)

When the **ENTER** button is pressed with the last digit selected, the screen will update to display the confirmation dialog (described previously). If ‘Yes’ is selected, the edit value is persisted as the new value for the voltage fault threshold for the selected external sensor. Otherwise, the edit value is rejected. In either case, the menu returns to the ‘Analog’ configuration sub-menu menu with the ‘Fault (V)’ menu item selected.

NOTE: This value only applies when the input mode is voltage mode and has a non-zero minimum input. For example, with an external sensor configured for operation between 2 - 10 V, setting a fault value of 1 V would lead to the sensor being found in a ‘FAIL’ state with an input voltage of less than 1 V.

CAUTION: Entering a fault value of 0 V disables the fault check.

If 'Fault (mA)' is activated from the 'Analog' configuration sub-menu, then the display will be updated to show the following editing screen.

← 'Fault (mA)' serves as a label only.

← Edit the current fault threshold value one digit at a time using the UP/DOWN buttons. Press ENTER to advance the cursor to the next digit. Press ENTER when the last digit is highlighted to save the value.

← Context sensitive help (for the currently highlighted menu item)

When the **ENTER** button is pressed with the last digit selected, the screen will update to display the confirmation dialog (described previously). If Yes is selected, the edit value is persisted as the new value for the current fault threshold for the selected external sensor. Otherwise, the edit value is rejected. In either case, the menu returns to the 'Analog' configuration sub-menu menu with the 'Fault (mA)' menu item selected.

NOTE: This value only applies when the input mode is current mode and has a non-zero minimum input. For example, with an external sensor configured for operation between 4 - 20 mA, setting a fault value of 2 mA would lead to the sensor being found in a 'FAIL' state with an input current of less than 2 mA.

CAUTION: Entering a fault value of 0 mA disables the fault check.

If 'Exit' is activated from the 'Analog' configuration sub-menu, then the user is returned to the sensor's service menu for an external sensor.

4.3.10.3 Sensor Sub-Menu

If the 'Sensor' sub-menu is activated from the sensor's service menu when an external sensor is selected, then the display will be updated to show the following sub-menu.

← Activate this menu item to edit the gas label for the selected sensor

← Activate this menu item to edit the engineering units for the selected sensor

← Activate this menu item to exit the external sensor service sub-menu

← Context sensitive help (for the currently highlighted menu item)

The **UP** and **DOWN** buttons can be used to navigate the list of sensor configuration options for the selected external sensor. The sensor configuration sub-menu is defined in the below table:

Table 4-10: Sensor Sub-Menu Options

Menu Item	Description
Gas Label	Activate this menu item to edit the gas label for the selected sensor.
Eng Units	Activate this menu item to edit the engineering units for the selected sensor.

Exit	Select this menu item to return to the sensor’s service menu. The ‘Config’ sub-menu will be selected when the sensor’s service menu appears.
------	--

4.3.10.4 Gas Label

If ‘Gas Label’ is activated from the ‘Sensor’ sub-menu, then the display will be updated to show the following editing screen.

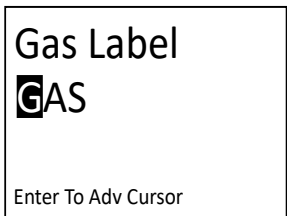

- ← ‘Gas Label’ serves as a label only, therefore, this item can not be selected.
- ← Edit the gas label value character at a time using the UP/DOWN buttons. Press ENTER to advance the cursor to the next character. Press ENTER when the last character (space) is highlighted to save the value.
- ← Context sensitive help (for the currently highlighted menu item)

Each character can be edited to any alpha-numeric value (A-Z, 0-9) including a space. When **ENTER** button is pressed with the last non-space character highlighted, a space will be appended to the label to allow expanding the label value.

When the **ENTER** button is pressed with the last character selected and that character is a space, the screen will update to display the confirmation dialog (described previously). If ‘Yes’ is selected, the edit value is persisted as the new value for the Gas Label for the selected external sensor. Otherwise, the edit value is rejected. In either case, the menu returns to the ‘Sensor’ configuration sub-menu menu with the ‘Gas Label’ menu item selected.

4.3.10.5 Engineering Units

If ‘ENG UNITS’ is activated from the ‘Sensor’ sub-menu, then the display will be updated to show the following editing screen.

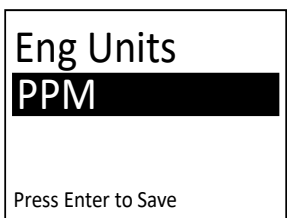

- ← ‘Eng Units’ serves as a label only.
- ← The engineering units can be selected from a list of options using the UP/DOWN Buttons to cycle between each option. Press ENTER to save the selected options.
- ← Context sensitive help (for the currently highlighted menu item)

The available options for ‘ENG UNITS’ are listed in the following table.

Table 4-11: Engineering Unit Options

Menu Item	Description
PPB	Parts per Billion
PPM	Parts per Million
% LEL	Percent of Lower Explosive Limit
% VOL	Percent by Volume
Volt	Voltage
% FS	Percent of Full Scale
% LFL	Percent of Lower Flammable Limit

When the **ENTER** button is pressed, the screen will update to display the confirmation dialog (described previously).

4.3.10.7 Simulation Of Gas Levels (External Sensors)

The External Sensor Menu allows the current gas reading of an external sensor to be overridden by a simulated gas level. This may be useful during the system commissioning to verify operation of the Monitor or alarm relays.

Table 4-12: External Override Sub-Menu Options

Menu Item	Description
Sim Enable	Menu item for turning the external gas override value on/off.
Sim Gas	Allows an external override value to be selected (only applied if Sim Enable set to “Enabled”).
Exit	Select this menu item to return to the external sensor service menu.

4.3.10.8 Override

If ‘Override’ sub-menu is activated from the external sensor’s service menu, then the display will be updated to show the following sub-menu.

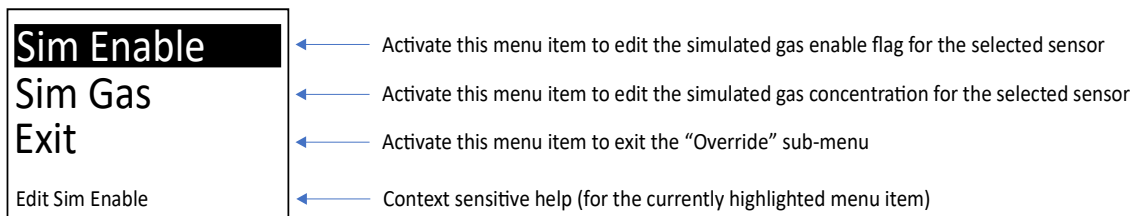

4.3.10.9 Sim Enable

If 'Sim Enable' is activated from the 'Override' sub-menu, then the display will be updated to show the following editing screen.

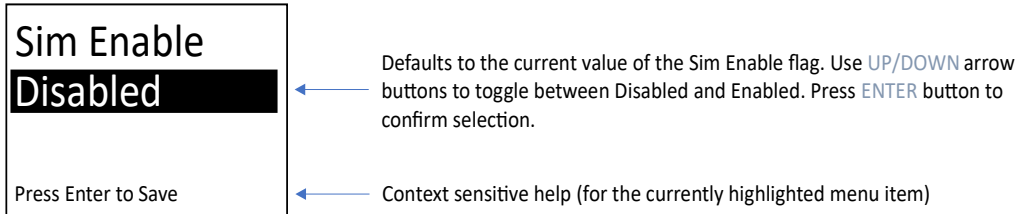

When the **ENTER** button is pressed, the confirmation screen (described previously) is displayed. If 'Yes' is selected, the edit value is persisted as the new value for the Sim Enable flag. Otherwise, the edit value is rejected. In either case, the menu returns to the Override sub-menu menu with the 'Sim Enable' menu item selected.

4.3.10.10. Sim Gas

If ‘Sim Gas’ is activated from the ‘Override’ sub-menu, then the display will be updated to show the following editing screen.

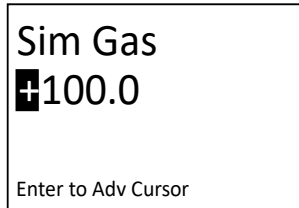

- ← ‘Sim Gas’ serves as a label only.
- ← Edit the simulated gas value one digit at a time using the UP/DOWN buttons. Press ENTER to advance the cursor to the next digit. Press ENTER when the last digit is highlighted to save the value.
- ← Context sensitive help

When the **ENTER** button is pressed with the last digit highlighted, the confirmation screen (described previously) is displayed. If ‘Yes’ is selected, the edit value is persisted as the new value for the Sim Gas concentration value. Otherwise, the edit value is rejected. In either case, the menu returns to the Override sub-menu menu with the ‘Sim Gas’ menu item selected.

Selected ‘Exit’ from the ‘Override’ sub-menu returns the user to the sensor’s service menu with the ‘Override’ menu item selected.

4.3.11 Transmitter Service Menu

If the ‘UTx’ menu item is activated from the main service menu via the **ENTER** button, then UTx service menu will appear on the display as shown in the following diagram.

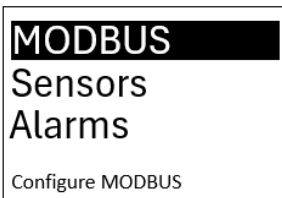

- ← Context sensitive help (for the currently highlighted menu item)

The **UP** and **DOWN** buttons can be used to navigate the list of service menus for the UTx. The following table outlines all the menu items from the UTx menu:

Table 4-13: Transmitter Service Menu Options

Menu Item	Description
Modbus	Select this menu item to activate the MODBUS sub-menu.
Sensors	Select this menu item to activate the Sensors sub-menu.
Alarms	Select this menu item to activate the Alarms sub-menu.
Relays	Select this menu item to activate the Relays sub-menu.
Test	Select this menu item to toggle the test enable flag.
Date	Select this menu item to adjust the Real-Time Clock (RTC) year, month, and day.



Time	Select this menu item to adjust the Real-Time Clock (RTC) hour and minute.
Reset	Select this menu item to trigger a software reset of the UTx.
Exit	Select this menu item to return to the main service menu. The menu item for the UTx will be selected when the main service menu appears.

4.3.11.1 Modbus Settings

From the UTx service menu, selecting ‘MODBUS’ will update the display to show the following sub-menu:

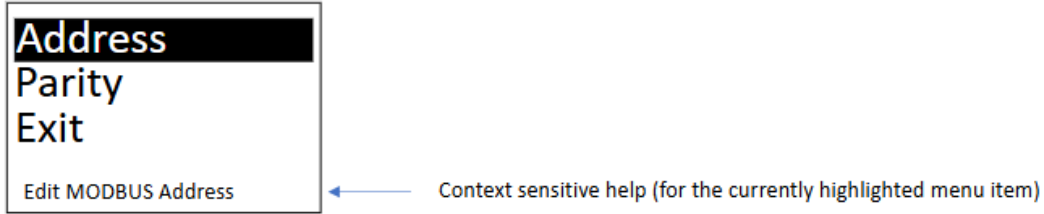

The **UP** and **DOWN** buttons can be used to navigate the list of menus for the MODBUS sub-menu. The following table outlines all the menu items from the MODBUS sub-menu:

Menu Item	Description
Address	Select this menu item to edit the MODBUS address.
Parity	Select this menu item to edit the RS485 parity setting.
Exit	Select this menu item to return to the UTx service menu. The MODBUS menu item will be selected when the UTx service menu appears.

4.3.11.2 Transmitter Sensors Settings

From the UTx service menu, selecting ‘Sensors’ will update the display to show the following sub-menu.

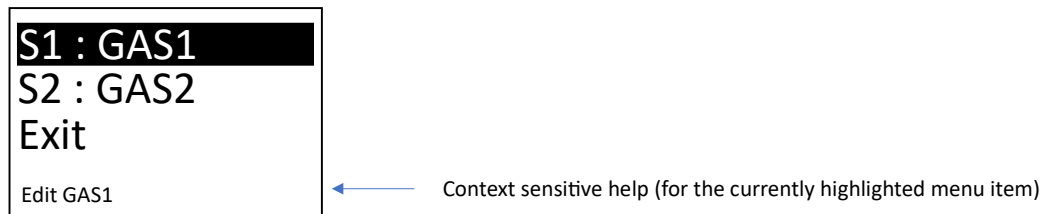

The **UP** and **DOWN** buttons can be used to navigate the list of configured sensors for the sensors sub-menu. The table below outlines all the menu items from the sensors sub-menu:

Table 4-14: Sensor Module Configuration Menu

Menu Item	Description
S1: GAS1	Select this menu item to activate the configuration sub-menu for sensor 1.
S2: GAS2	Select this menu item to activate the configuration sub-menu for sensor 2.
Exit	Select this menu item to return to the UTx service menu.

4.3.11.3 Sensor Alarm Configuration Sub-Menu

Selecting a sensor from the ‘Sensors’ sub-menu (ex: S1: GAS1) will update the display to show the following sub-menu.

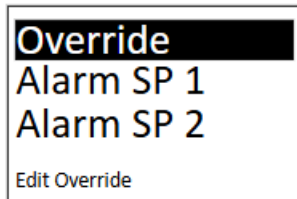

← Context sensitive help (for the currently highlighted menu item)

The **UP** and **DOWN** buttons can be used to navigate the list of menus for the ‘Sensors’ sub-menu. The below table outlines all the menu items from the sensor sub-menu:

Table 4-15: Sensor Alarm Configuration

Menu Item	Description
Override	Override sub-menu item for the selected sensor.
Alarm SP 1-3	Select this menu item to edit the alarm setpoints for the selected alarm (1-3).
Alarm Hyst	Select this menu item to edit the alarm hysteresis. This hysteresis value is applied to all alarm setpoints.
Zero Buff	Select this menu item to edit the zero-buffer level for the display of small gas concentrations.
Cal Freq	Select this menu item to edit the time period between re-calibrations.
Exit	Select this menu item to return to the Sensors sub-menu.

4.3.11.3.1 Override

The override menu item allows the current gas reading to be overridden by a simulated gas level. This may be useful during system configuration to verify operation of the Digital Monitor or alarm relays.

NOTE: An override menu item may be found in the Sensor Service menus. It's usage is identical. Should the user activate the override through both menus at the same time, the override value entered through this Sensor Alarm Configuration sub-menu will take precedence.

If 'Override' is activated from the Sensor Alarm Configuration sub-menu, then the display will be updated to show the following sub-menu:

- ← Activate this menu item to edit the simulated gas enable flag for the selected sensor
- ← Activate this menu item to edit the simulated gas concentration for the selected sensor
- ← Activate this menu item to exit the 'Override' sub-menu
- ← Context sensitive help (for the currently highlighted menu item)

If 'Sim Enable' is activated from the 'Override' sub-menu, then the display will be updated to show the following editing screen.

- ← Defaults to the current value of the Sim Enable flag. Use UP/DOWN arrow buttons to toggle between Disabled and Enabled. Press ENTER button to confirm selection.
- ← Context sensitive help

When the **ENTER** button is pressed, the confirmation screen (described previously) is displayed. If 'Yes' is selected, the edit value is persisted as the new value for the Sim Enable Flag. Otherwise, the edit value is rejected. In either case, the menu returns to the Override sub-menu menu with 'Sim Enable' menu is selected.

- ← Activate this menu item to edit the simulated gas enable flag for the selected sensor
- ← Activate this menu item to edit the simulated gas concentration for the selected sensor
- ← Activate this menu item to exit the 'Override' sub-menu
- ← Context sensitive help (for the currently highlighted menu item)

If 'Sim Gas' is activated from the 'Override' sub-menu, then the display will be updated to show the following editing screen.

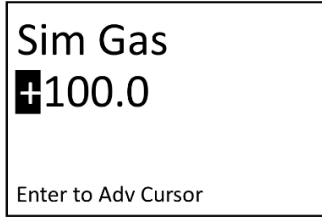

- ← 'Sim Gas' serves as a label only, therefore, this item can not be selected.
- ← Edit the simulated gas value one digit at a time using the UP/DOWN buttons. Press ENTER to advance the cursor to the next digit. Press ENTER when the last digit is highlighted to save the value.
- ← Context sensitive help

When the **ENTER** button is pressed with the last digit highlighted, the confirmation screen (described previously) is displayed. If 'Yes' is selected, the edit value is persisted as the new value for the Sim Gas concentration value. Otherwise, the edit value is rejected. In either case, the menu returns to the Override sub-menu menu with the 'Sim Gas' menu item selected.

Selected 'Exit' from the 'Override' sub-menu returns the user to the Sensor Alarm Configuration sub-menu with the 'Override' menu item selected.

4.3.11.3.2 Setpoint

If 'Alarm SP 1' is activated from the sensor alarm configuration sub-menu, then the display will be updated to show the following editing screen.

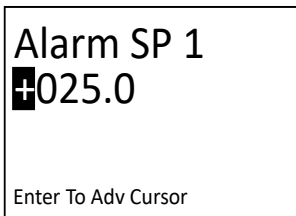

- ← 'Alarm SP 1' serves as a label only.
- ← Edit the alarm 1 setpoint value one digit at a time using the UP/DOWN buttons. Press ENTER to advance the cursor to the next digit. Press ENTER when the last digit is highlighted to save the value.
- ← Context sensitive help

When the **ENTER** button is pressed, the screen will update to display the confirmation dialog (described previously).

The same process is repeated for Alarm SP 2 and Alarm SP 3. In all cases, once the confirmation dialog is reached, regardless of which option it selected, the user is returned back to the Sensors sub-menu.

4.3.11.3.3 Alarm Hysteresis

If 'Alarm Hyst' is activated from the sensor sub-menu, then the display will be updated to show the following editing screen.



- ← 'Alarm Hyst' serves as a label only.
- ← Edit the alarm hysteresis setpoint value one digit at a time using the UP/DOWN buttons. Press ENTER to advance the cursor to the next digit. Press ENTER when the last digit is highlighted to save the value.
- ← Context sensitive help

When the **ENTER** button is pressed, the screen will update to display the confirmation dialog (described previously). If ‘Yes’ is selected, the edit value is persisted as the new value for the Alarm Hysteresis for the selected sensor. Otherwise, the edit value is rejected. In either case, the menu returns to the Sensor sub-menu menu with the ‘Alarm Hyst’ menu item selected.

4.3.11.3.4 Zero Buffer

If ‘Zero Buff’ is activated from the sensor sub-menu, then the display will be updated to show the following editing screen.

← ‘Zero Buff’ serves as a label only.

← Edit the alarm hysteresis setpoint value one digit at a time using the UP/DOWN buttons. Press ENTER to advance the cursor to the next digit. Press ENTER when the last digit is highlighted to save the value.

← Context sensitive help

When the **ENTER** button is pressed, the screen will update to display the confirmation dialog (described previously). If ‘Yes’ is selected, the edit value is persisted as the new value for the Zero Buffer for the selected sensor. Otherwise, the edit value is rejected. In either case, the menu returns to the Sensor sub-menu menu with the ‘Zero Buff’ menu item selected.

4.3.11.3.5 Calibration Frequency

If ‘Cal Freq’ is activated from the sensor sub-menu, then the display will be updated to show the following editing screen.

← ‘Cal Freq’ serves as a label only.

← The calibration frequency can be selected from a list of options using the UP/DOWN buttons to cycle between each option. Press ENTER to save the selected options.

← Context sensitive help

The available options for ‘Cal Freq’ are listed in the table below.

Table 4-16: Calibration Frequency Configuration

Menu Item	Description
OFF	Next calibration due date is not calculated.
3 Months	Next calibration due date is calculated as 3 months from last calibration timestamp.
4 Months	Next calibration due date is calculated as 4 months from last calibration timestamp.
6 Months	Next calibration due date is calculated as 6 months from last calibration timestamp.

12 Months	Next calibration due date is calculated as 12 months from last calibration timestamp.
-----------	---

When the **ENTER** button is pressed, the screen will update to display the confirmation dialog (described previously).

4.3.11.4 Transmitter Alarms Settings

From the UTx service menu, selecting 'Alarms' will update the display to show the following sub-menu.

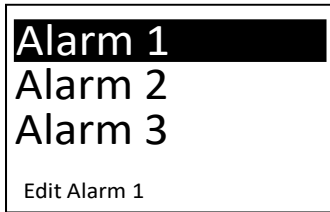

← Context sensitive help (for the currently highlighted menu item)

The **UP** and **DOWN** buttons can be used to navigate the list of menus for the Alarms sub-menu. The table below outlines all the menu items from the Alarms sub-menu:

Table 4-17: Transmitter Alarm Settings

Menu Item	Description
Alarm 1-18	Select this menu item to activate the configuration sub-menu for the selected alarm.
Exit	Select this menu item to return to the UTx service menu. The alarms menu item will be selected when the UTx service menu appears.

4.3.11.4.1 Alarm Sub-Menu

Selecting an alarm from the alarms sub-menu will update the display to show the following:

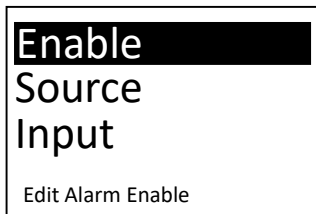

← Context sensitive help (for the currently highlighted menu item)

The below table outlines all the menu items from the alarm sub-menu:

Table 4-18: Transmitter Alarm Sub-Menu Settings

Menu Item	Description
Enable	Select this menu item to edit the alarm enable state.



Source	Select this menu item to edit the alarm source (i.e. from the available sensors).
Input	Select this menu item to edit the alarm input value.
Level	Select this menu item to edit the alarm setpoint.
Type	Select this menu item to edit the alarm type (increasing or decreasing).
Output	Select this menu item to edit the alarm trigger output (i.e. activate which relays).
Act Delay	Select this menu item to edit the alarm act delay in terms of seconds.
Min Run	Select this menu item to edit the alarm minimum run time in terms of seconds.
Exit	Select this menu item to return to the alarm sub-menu.

4.3.11.4.2 Enable

If 'Enable' is activated from the alarm sub-menu, then the display will be updated to show the following editing screen.

'Enable' serves as a label only.

Defaults to the current value of the Enable flag. Use UP/DOWN arrow buttons to toggle between Disabled and Enabled. Press ENTER button to confirm selection.

Context sensitive help

When the **ENTER** button is pressed, the confirmation screen (described previously) is displayed.

4.3.11.4.3 Source

If 'Source' is activated from the alarm sub-menu, then the display will be updated to show the following editing screen.

'Source' serves as a label only.

The source can be selected from a list of sensors. Cycle through all the values using the UP/DOWN buttons.

Context sensitive help

The available options for 'Source' is equal to the list of sensors currently configured for the UTx. The label for each sensor is dynamically assigned to S<n> : GAS<n> where n represents the sensor's 1 base index and GAS represents the sensor's gas name in short form.

When the **ENTER** button is pressed, the screen will update to display the confirmation dialog (described previously).

4.3.11.4.4 Input

If 'Input' is activated from the alarm sub-menu, then the display will be updated to show the following editing screen.

'Input' serves as a label only.

The input can be selected from a list of options using the UP/DOWN buttons to cycle between each option. Press ENTER to save the selected options.

Context sensitive help

The available options for ‘Input’ are listed in the below table:

Table 4-19: Alarm Input Options

Menu Item	Description
Inst. Value	Instantaneous gas value, updated once per second.
15m Avg	Gas concentration averaged over the past 15 minutes.
8h Avg	Gas concentration averaged over the past 8 hours.
Daily Peak	Daily peak value.

4.3.11.4.5 Level

If ‘Level’ is activated from the alarm sub-menu, then the display will be updated to show the following editing screen.

The available options for ‘Level’ are listed in the below table:

Table 4-20: Alarm Setpoint Options

Menu Item	Description
Alarm SP 1	Alarm setpoint 1 from the selected source.
Alarm SP 2	Alarm setpoint 2 from the selected source.
Alarm SP 3	Alarm setpoint 3 from the selected source.

When the **ENTER** button is pressed, the screen will update to display the confirmation dialog (described previously).

4.3.11.4.6 Type

If ‘Type’ is activated from the alarm sub-menu, then the display will be updated to show the following editing screen.

The available options for ‘Type’ are listed in the below table:

Table 4-21: Alarm Type Options

Menu Item	Description
Increasing	Alarm is triggered when alarm exceeds its threshold in an increasing direction.
Decreasing	Alarm is triggered when alarm exceeds its threshold in a decreasing direction.

When the **ENTER** button is pressed, the screen will update to display the confirmation dialog (described previously).

4.3.11.4.7 Output

If 'Output' is activated from the alarm sub-menu, then the display will be updated to show the following editing screen.

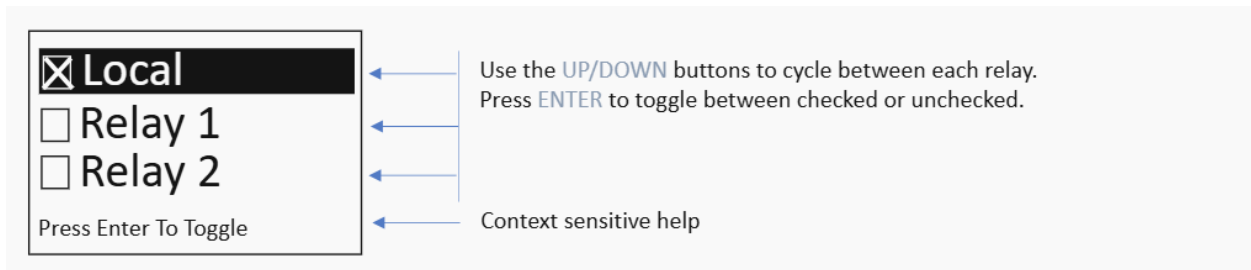

The available options for 'Output are 'Local' and 'Relay 1' through 'Relay 5' (depending on variant). If the checkbox next to the relay is checked, then that relay will activate when the associated alarm is active. Otherwise, the relay will not activate.

When the **ENTER** button is pressed with 'Done' selected, the screen will update to Transmitter Alarm Sub-Menu.

4.3.11.4.8 Act Delay

If 'Act Delay' is activated from the Alarm sub-menu, then the display will be updated to show the following editing screen.

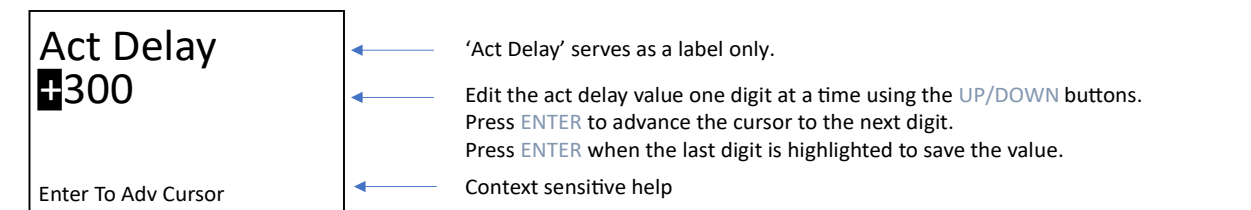

When the **ENTER** button is pressed while the last digit is highlighted, the screen will update to display the confirmation dialog (described previously).

4.3.11.4.9 Min Run

If 'Min Run' is activated from the Alarm sub-menu, then the display will be updated to show the following editing screen.

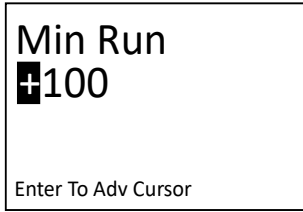

- ← Edit the minimum run time value one digit at a time using the UP/DOWN buttons. Press ENTER to advance the cursor to the next digit. Press ENTER when the last digit is highlighted to save the value.
- ← Context sensitive help

When the **ENTER** button is pressed while the last digit is highlighted, the screen will update to display the confirmation dialog (described previously).

4.3.11.5 Transmitter Relay Settings

From the UTx service menu, selecting 'Relays' will update the display to show the following sub-menu.

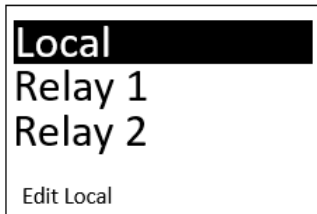

- ← Context sensitive help (for the currently highlighted menu item)

The **UP** and **DOWN** buttons can be used to navigate the list of menus for the Relays sub-menu. The following table outlines all the menu items from the Relays sub-menu:

Menu Item	Description
Local	Select this menu item to activate the configuration sub-menu for the local relay.
Relay 1-5	Select this menu item to activate the configuration sub-menu for the selected relay (ranging from 1 to 5).
Exit	Select this menu item to return to the UTx service menu. The Relays menu item will be selected when the UTx service menu appears.

Selecting a relay from the Relays sub-menu will update the display to show the following:

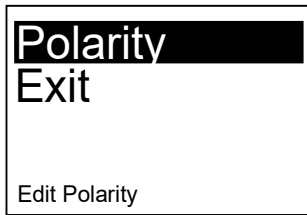

← Context sensitive help (for the currently highlighted menu item)

The following table outlines all the menu items from the relay sub-menu:

Menu Item	Description
Polarity	Select this menu item to edit the relay's polarity setting.
Exit	Select this menu item to return to the Relays sub-menu.

If 'Polarity' is activated from the relay sub-menu, then the display will be updated to show the following editing screen.



← Context sensitive help (for the currently highlighted menu item)

The available options for 'Polarity' are listed in the following table.

Menu Item	Description
Normal	Relay output is energized when associated alarm is active. Otherwise, the relay output is de-energized.
Reverse	Relay output is de-energized when associated alarm is active. Otherwise the relay output is energized.

When the **ENTER** button is pressed, the screen will update to display the confirmation dialog (described previously).

4.3.11.6 Outputs

Analog output configuration is handled via the Outputs menu available from the main service menu. With the Outputs menu it is possible to configure the analog output to use multiplexed sensor sources to determine the output response; this section concludes with an example. Once in the Outputs menu, the **UP** and **DOWN** buttons can be used to navigate the list of available analog outputs to be configured.

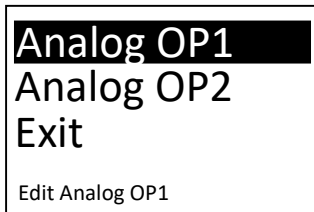

← Context sensitive help (for the currently highlighted menu item)

Table 4-22: Outputs Sub-Menu

Menu Item	Description
Source	Allows the analog output channel to be driven based on desired gas sources. With this menu item, it is possible to multiplex several of the available gases together to drive the output.
Mode	Used to select between voltage or current analog output modes.
Range	Can be used to adjust the output range. The units in the menu are either V or mA, depending on the selection chosen with the Mode menu item.

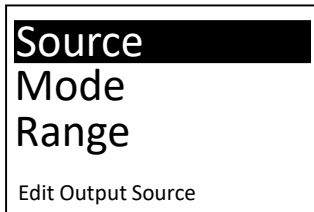

← Context sensitive help (for the currently highlighted menu item)

4.3.11.6.1 Source

When the **ENTER** button is pressed with Source selected, the list of available gases will be presented. A checkbox to the left of each gas label indicates if a gas is being used in the calculation of the analog output.

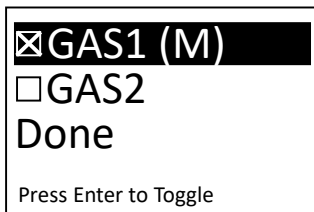

← Context sensitive help (for the currently highlighted menu item)

To the right of each enabled gas an “M” or “A” in brackets denotes which gas concentration is used in scaling the output response. The “M” indicates that the maximum supported gas concentration of the sensor is used in scaling the output response. An “A” indicates that the gas concentration tied to the high alarm (Alarm SP 3, see the ‘**Transmitter Sensor Settings**’ section, is used as max scale in the calculation of the analog output response.

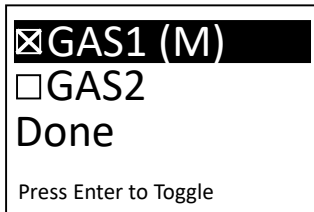

← Context sensitive help (for the currently highlighted menu item)

When the **ENTER** button is pressed with an unchecked gas selected, a screen will be presented to allow the selection between the max gas concentration (“MAX”) or Alarm SP 3 (“HI ALARM”). Use the **UP** and **DOWN** buttons to select between the two options, and press **ENTER** to confirm the selection. This will cause a return to Source sub-menu with the gas as checked. Pressing the **ENTER** button on an already checked gas will cause it to become unchecked and clear the “M” or “A” setting.

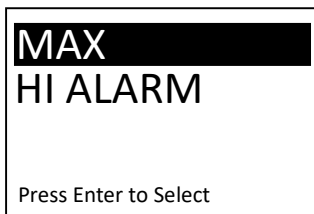

← Press UP/DOWN to toggle between options.

← Context sensitive help (for the currently highlighted menu item)

4.3.11.6.2 Mode

From the Outputs menu, when the **ENTER** button is pressed with Mode selected, a menu option to select between and analog output mode of voltage or current will be presented. Use the UP and DOWN buttons to select between the two options, and press **ENTER** to confirm the selected mode.

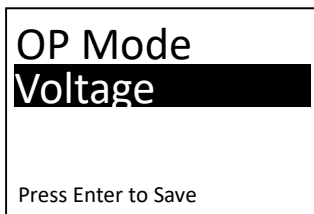

← Press UP/DOWN to toggle between voltage and current output modes.

← Context sensitive help (for the currently highlighted menu item)

4.3.11.6.3 Range

From the Outputs menu, when the **ENTER** button is pressed with Range selected, a sub-menu to configure the minimum and maximum analog output response will become available. The engineering unit (V or mA) displayed in the Output Min/Max menu items will reflect the analog output mode selected with the Mode menu item.

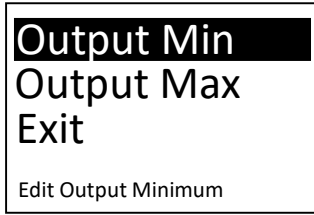

← Context sensitive help (for the currently highlighted menu item)

The permitted analog output range for voltage mode is between 0-10V.

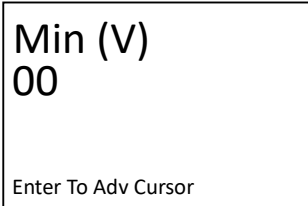

- ← 'Min (V)' serves as a label only.
- ← Edit the window filter value one digit at a time using the UP/DOWN buttons. Press ENTER to advance the cursor to the next digit. Press ENTER when the last digit is highlighted to save the value.
- ← Context sensitive help

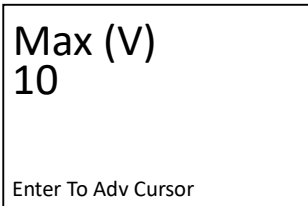

- ← 'Max (V)' serves as a label only.
- ← Edit the window filter value one digit at a time using the UP/DOWN buttons. Press ENTER to advance the cursor to the next digit. Press ENTER when the last digit is highlighted to save the value.
- ← Context sensitive help

The permitted analog output range for current mode is between 0-20mA.

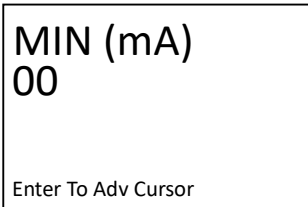

- ← 'MIN (mA)' serves as a label only.
- ← Edit the window filter value one digit at a time using the UP/DOWN buttons. Press ENTER to advance the cursor to the next digit. Press ENTER when the last digit is highlighted to save the value.
- ← Context sensitive help

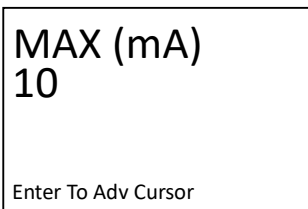

- ← 'MAX (mA)' serves as a label only.
- ← Edit the window filter value one digit at a time using the UP/DOWN buttons. Press ENTER to advance the cursor to the next digit. Press ENTER when the last digit is highlighted to save the value.
- ← Context sensitive help

4.3.11.6.4 Multiplexing Example

With an overview of the Outputs menu complete, it is worthwhile to show an example of how a multiplexed sensor configuration can be used to drive the analog output. In this example, the following configuration is used:

- Voltage output mode on OP1.

- 2-10V range selected for OP1.
- GAS1, with a max gas concentration of 100 PPM, and Alarm SP 3 of 100 PPM.
- GAS2, with a max gas concentration of 10 PPM, and Alarm SP 3 of 3 PPM.
- GAS1 and GAS2 are to be multiplexed; whichever gas has a higher percentage of maximum scale is to drive the output.
- GAS1 is using the max gas concentration for scaling (“M”), whereas GAS2 is using Alarm SP 3 (“A”).

Suppose GAS1 has a present reading of 7 PPM, and GAS2 has a present reading of 0.5 PPM. GAS1 has a percent of max scale of $7/100=0.07$. GAS2 has a percent of max scale of $0.5/3=0.16$. As a result, it is GAS2 that presently determines the analog output response.

The range selected for voltage mode is $(10V - 2V) = 8V$. Accounting for the output offset (Output Min) of 2V, the analog output value will be found to be $2V + 0.16 * 8V = 3.33 V$.

4.3.11.7 RTC Date & Time

The main service menu Date and Time items can be used to update the on-board real-time clock (RTC). The RTC runs on battery power when main power is unavailable. These menus provide a mechanism to update the date and time, for example, in the event of low battery during a power outage.

Use the **UP** and **DOWN** buttons to scroll through available year, month, and day options. A short press of the **ENTER** button will advance to the next digit. A long press of the **ENTER** button will return to the previous digit. Press the **ENTER** button on the last digit to proceed to the confirmation Save dialog.

YY-MM-DD
23-10-29
Enter To Adv Cursor

← ‘YY-MM-DD’ serves as a label only.

← Context sensitive help

Button presses for Time menu behave in the same manner as the Date menu. Note that it is only possible to update the RTC hour and minute currently.

HH:MM
06:27
Enter To Adv Cursor

← ‘HH:MM’ serves as a label only.

← Context sensitive help



4.3.12 Calibration

Sensors naturally degrade over time, losing about 2% of their sensitivity per month. Over time a sensor will start to underreport gas concentrations, meaning that a calibration is necessary to maintain a safe environment.

When the unit is due for calibration the Sensor Module LED will blink CYAN-YELLOW as opposed to its usual green to be able to see at a glance which sensor(s) is(are) overdue.

Information on Calibration Dates (when calibration is due, calibration frequency) can be found in the UTx Menu.

Caution:

- Only qualified personnel should perform the actual calibration.
- Users new to gas calibration are advised to consult with Armstrong Monitoring.

The Armstrong Monitoring Corporation offers the following calibration plans:

1. Factory pre-calibrated exchange replacement of Sensor Modules.
2. On site installation by Armstrong Monitoring.
3. On site calibration by Armstrong Monitoring.
4. Training by Armstrong Monitoring for end users.

For additional details, please refer to the above **Contact Information** section.

4.3.12.1 Required Equipment; EZ Cal Exchange Program

The following is a recommended list of equipment required:

- Phillips and Robertson screwdriver set.

4.3.12.2 Required Equipment; On-Site Sensor Module Calibration

For qualified personnel, the following is recommended calibration gas for calibration of the AMC-UTx:

UTx Model No.	Recommended Calibration Gas
AMC-UTx-M-91A01-N-R-0000	100ppm CO
AMC-UTx-M-98B01-N-R-0000	300ppm CO
AMC-UTx-M-98A01-N-R-0000	6ppm NO ₂
AMC-UTx-M-91A01-98A01-R-0000	100ppm CO
AMC-UTx-M-VCA01-N-R-0000	6ppm NO ₂
AMC-UTx-M-VCB01-N-R-0000	300ppm CO 6ppm NO ₂
AMC-UTx-M-60A01-N-R-0000	50% LEL CH ₄
AMC-UTx-M-61A01-N-R-0000	50% LEL C ₃ H ₈
AMC-UTx-M-62A01-N-R-0000	50% LEL H ₂



AMC-UTx-M-70A01-N-R-0000

Pure Nitrogen

Note: Calibration gas concentrations above 105ppm CO for 100ppm CO Sensors and 315ppm CO for 300ppm CO Sensors are not supported by the UTx Menu.

For NO₂ Sensors, calibration gas concentrations greater than 10.5ppm are not supported by the UTx menu.

Please refer to the above **UTx Calibration Kit** section for the UTx Calibration Kit that provides the mating adaptor for connecting the calibration gas cylinder to the face of the UTx Sensor Module.

4.3.12.3 Pre Bump Test

Before calibration, a bump test ("as found test") is usually performed to ensure each sensor is in working order and returning reasonable responses. The bump test involves applying a test gas to the sensor. However, sensors such as CO have a recovery time measured in multiple hours. As a result, the calibration routine would find a zero at a concentration that is not the true background concentration, should the sensor not have sufficient recovery time.

The "As Found" menu item (see below **Menu Flow Diagrams** section for **Sensor Service Menu Flow Diagram** figure) allows the user to enter the measured background concentration before performing a bump test. This value is persisted in memory for 24 hours. If a calibration is performed during this 24h period, the persisted background concentration will be used to negate the effect of the bump test and sensor recovery time on the calibration process.

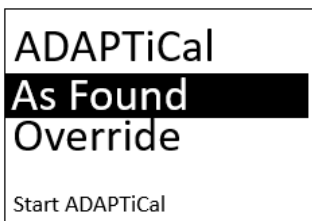

← Context sensitive help (for the currently highlighted menu item)

Before performing a bump test, navigate to the "As Found" menu and enter the current background reading. The user should then navigate to the main screen so that the gas concentration may be monitored during the bump test. The user may then apply a test gas and monitor the response.

4.3.12.4 Calibration Procedure – Menu

Navigate to the UTx Service Menu and select the sensor to be calibrated. If the **ENTER** button is pressed, then the following menu is shown. This menu is common to all sensors therefore selecting any sensor will produce the same menu.

Please refer to the above **Pre Bump Test** section for specific calibration details.



← Context sensitive help (for the currently highlighted menu item)

The **UP** and **DOWN** buttons can be used to navigate the list of service menus for the selected sensor. The sensor’s service menu provides the following menu items:

Menu Item	Description
ADAPTiCal	Select this menu item to start calibration for the selected sensor.
As Found	Allows user to enter the background concentration reading before performing a bump test. (Refer to the above Bump Test section for further explanation).
Override	Allows user to override the current sensor value for the selected sensor. (Refer to the below Simulation of Gas Levels section).
Reset	Allows user to trigger a software reset of the selected sensor.
Exit	Select this menu item to return to the main service menu. The current sensor will be selected when the main service menu appears.



← Context sensitive help (for the currently highlighted menu item)

With ‘ADAPTiCal’ highlighted (as above), press **ENTER** to initiate a calibration sequence for the selected sensor. Once initiated, the user will be presented with the following screens in which the background and span level concentrations used for the calibration can be entered:

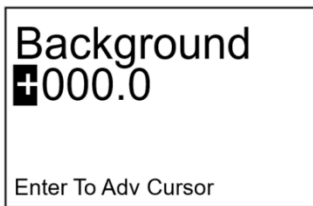

- ← ‘Background’ serves as a label only.
- ← Edit the current background one digit at a time using the **UP/DOWN** buttons. Press **ENTER** to advance the cursor to the next digit. Press **ENTER** when the last digit is highlighted to save the value.
- ← Context sensitive help



Span Level
100.0
Enter To Adv Cursor

- ← 'Span Level' serves as a label only.
- ← Edit the span level value one digit at a time using the UP/DOWN buttons. Press ENTER to advance the cursor to the next digit. Press ENTER when the last digit is highlighted to save the value.
- ← Context sensitive help

Once the background and span level gas concentrations are entered, the calibration procedure will start automatically, and the state of the calibration will be displayed on the display as shown below. Throughout the entire calibration procedure, the Abort command remains highlighted therefore the procedure can be aborted at any time by pressing the **ENTER** button.

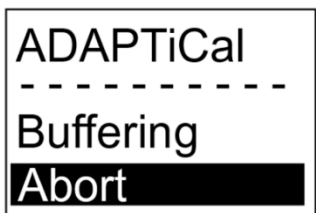

ADAPTiCal

Buffering
Abort

- ← Current state of the calibration procedure
- ← Abort command remains highlighted throughout the entire procedure

During calibration, the procedure will transition through the following set of states:

Menu Item	Description
Buffering	A software register is acquiring data before the gas level can be evaluated.
Find Zero	The gas concentration for 'zero' gas is determined.
Apply Gas	Procedure is ready for the user to apply gas. User will be prompted to be press the ENTER button after the OK command is highlighted in order to indicate when they have applied gas.
Find Gas	Calibration routine will stay in this state until it has detected the full application of gas.
Find Span	Calibration is underway with the specified gas applied. This state will remain active until it either passes or fails.

When the calibration procedure completes its cycle, the result will either be a PASSED or FAILED with calibration results as shown by the following two images.

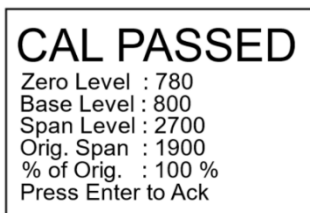

← Pressing the **ENTER** button returns the display to the ADAPTiCal menu item

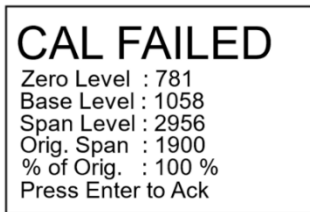

← When a calibration fails for a sensor that was previously calibrated successfully (e.g. factory calibrated), original span is retained.

← Pressing the **ENTER** button returns the display to the ADAPTiCal menu item

In either case, the OK command is highlighted, therefore, press the **ENTER** button to return to the sensor's service menu.

4.3.12.5 Calibration Procedure – Routine

Note: If an “As Found” (Bump Test) is to be performed prior to calibration, first follow the routine outlined in the above **Pre Bump Test** section.

1. To begin calibration, go to the menu, and select the sensor to be calibrate, then select “ADAPTiCal”. Refer to the above **Calibration Menu** section for details.
2. The operator will be asked to provide a background gas concentration. Use the arrow keys to adjust the rightmost digit while pressing enter to commit each digit. Repeat this for all digits.
 - a. It is recommended that prior to calibration to manually set the ventilation system to reduce the background gas concentration to near zero.



- b. It is recommended to use a trusted secondary measurement device (such as a handheld gas meter) to obtain an accurate reading of the background gas concentration. Enter this value for the background gas concentration when prompted.
- c. If background gas concentration cannot be reduced to near zero or if the background gas concentration cannot be established, apply pure nitrogen gas to the sensor prior and during the finding zero stage of calibration. Enter 0 for the background gas concentration when prompted.

CAUTION:

In the case of repeated CO Gas Calibrations performed in quick succession (i.e. less than 30 minutes apart) first follow the routine outlined in the ‘PRE BUMP TEST’ section. Then use the Background value provided by the unit during ADAPTICal startup.

A CO sensor element has a tendency to increase its background zero offset after each span gassing. Entering a Background of 0.0 in the second or third attempt can lead to failed calibration.

3. The operator will then be asked to provide a span level gas concentration (i.e. the concentration of the target gas that is in the cylinder being used to calibrate). Use the arrow keys to adjust the rightmost digit while pressing enter to commit each digit. Repeat this for all digits.
 - a. It is recommended that this concentration be relatively close to the maximum span range of the sensor for best results (as an example, service technicians could use 75ppm gas concentration cylinder for calibrating 100ppm CO Span sensor, however we recommend 100ppm CO).
4. The sensor will enter buffering and the “Find Zero” stage of calibration, assessing the output at the background concentration. When this stage succeeds, the operator will be notified on screen, and the calibration routine will pause until it is acknowledged. Before acknowledging, get the target span gas ready to flow. When **ENTER** is pressed, start applying the gas.
5. The sensor will wait until it detects gas and will enter the “Find Span” stage of calibration. This typically takes between 30 and 180 seconds.
6. Once this stage succeeds, the sensor will check that the result is within limits and notify the operator whether the calibration routine has failed or succeeded. The operator maybe be notified if sensor is nearing end of life.
7. If the calibration fails, the calibration can be attempted again right away, but it is recommended that the operator accepts the background gas concentration provided by the unit since the unit will retain the original background gas concentration.



5. Maintenance

5.1 General

Maintenance is a crucial activity that should be done at the proper time intervals, which are discussed below.

The AMC-UTx-M-xx-400 should be brushed or wiped as required, depending on the rate of accumulation of any dust or dirt.

To avoid sensor damage, the unit **MUST NOT** be submerged in any liquids. Hosing or splashing of the unit with any liquids must also be avoided.

Ensure the green indicators (LEDs) are slowly blinking to indicate a healthy state.

5.2 Scheduled Calibration

Scheduled calibration is critical in maintaining proper function of the AMC-UTx-M-xx-400. It is recommended that the Sensor Module(s) be calibrated a minimum of twice a year or more often for demanding workplace applications. As mentioned, Armstrong Monitoring Corporation offers a number of different maintenance plans to suit your requirements. Please see the above **Contact Information** section for more details.

5.3 Sensor Module

The Sensor Module tracks time since last calibration and will indicate via LED status when service is required. When the Sensor Module can no longer be calibrated, replacement is required; See the **Sensor Module** section for replacement sensor P/N.

5.3.1 Sensor Module Replacement

AMC-UTx-M-xx-400 Sensor Modules are designed to be field replaceable. When changing the sensor module, first ensure that the unit is fully powered down.

5.3.1.1 Remove Sensor Module

Detach the Cable to the top connector on the Sensor Module. Note depending upon Sensor Module position the cable will either connect the Sensor Module to the UTx-Main CCA or to the adjacent Sensor Module.

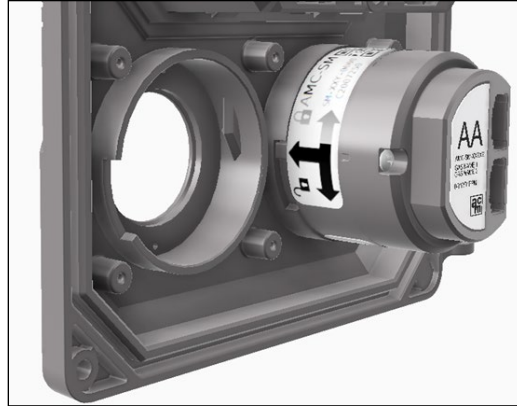

Figure 5-1: Disconnect Sensor Module

Rotate the Sensor Module so the tab aligns as shown and remove from the UTx Lid Assembly.

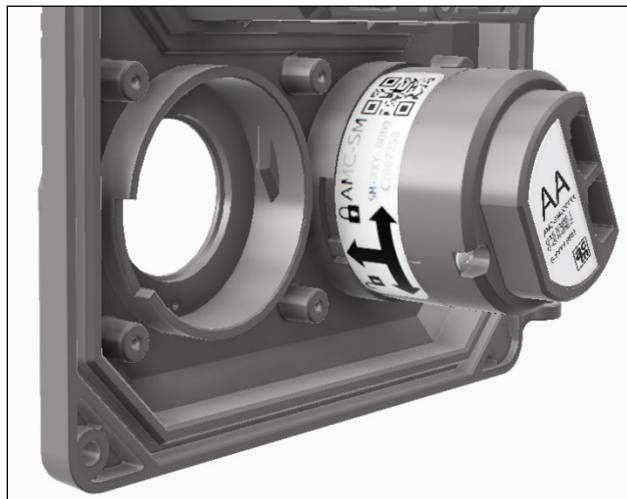

Figure 5-2: Removing Sensor Module from Lid

5.3.1.2 Install Sensor Module

To install the replacement Sensor Module, assemble the Sensor Module to the UTx Lid Assembly.

- Rotate the Sensor Module so the tab aligns as shown.
- Push and turn clockwise until the Sensor module is secured.



Figure 5-3: Installing Sensor Module

Attach the Cable to the top connector on the Sensor Module. Note: depending upon Sensor Module position the cable will either connect the Sensor Module to the UTx-Main CCA or to the adjacent Sensor Module.



Figure 5-4: Attaching Cable to Sensor Module

5.4 Verification of Operation

Verification of operation should be performed at least once every 6 months. For highly demanding applications more frequent verification is recommended.

5.4.1 Simulation of Gas Levels

The UTx Sensor Service Menu allows the current gas reading to be overridden by a simulated gas level. This may be useful during system configuration to verify operation of the Digital Monitor or alarm relays.

If 'Override' is activated from the sensor's service menu, then the display will be updated to show the following sub-menu.

The screenshot shows a menu with the following items: **Sim Enable**, **Sim Gas**, **Exit**, and **Edit Sim Enable**. The **Sim Enable** item is highlighted. Four blue arrows point from the annotations to the corresponding menu items:

- ← Activate this menu item to edit the simulated gas enable flag for the selected sensor
- ← Activate this menu item to edit the simulated gas concentration for the selected sensor
- ← Activate this menu item to exit the 'Override' sub-menu
- ← Context sensitive help (for the currently highlighted menu item)

If 'Sim Enable' is activated from the 'Override' sub-menu, then the display will be updated to show the following editing screen.

The screenshot shows the editing screen for 'Sim Enable'. The text **Sim Enable** is at the top, and **Disabled** is highlighted in a black bar. Below the bar is the text **Press Enter to Save**. Two blue arrows point from the annotations to the screen:

- ← Defaults to the current value of the Sim Enable flag. Use UP/DOWN arrow buttons to toggle between Disabled and Enabled. Press ENTER button to confirm selection.
- ← Context sensitive help

When the **ENTER** button is pressed, the confirmation screen (described previously) is displayed. If 'Yes' is selected, the edit value is persisted as the new value for the Sim Enable Flag. Otherwise, the edit value is rejected. In either case, the menu returns to the Override sub-menu menu with the 'Sim Enable' menu item selected.

The screenshot shows the 'Override' sub-menu with the following items: **Sim Enable**, **Sim Gas**, **Exit**, and **Edit Sim Gas Enabled**. The **Sim Gas** item is highlighted. Four blue arrows point from the annotations to the corresponding menu items:

- ← Activate this menu item to edit the simulated gas enable flag for the selected sensor
- ← Activate this menu item to edit the simulated gas concentration for the selected sensor
- ← Activate this menu item to exit the 'Override' sub-menu
- ← Context sensitive help (for the currently highlighted menu item)

If 'Sim Gas' is activated from the 'Override' sub-menu, then the display will be updated to show the following editing screen.

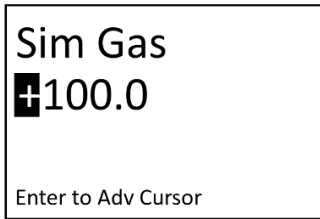

- ← 'Sim Gas' serves as a label only, therefore, this item can not be selected.
- ← Edit the simulated gas value one digit at a time using the UP/DOWN buttons. Press ENTER to advance the cursor to the next digit. Press ENTER when the last digit is highlighted to save the value.
- ← Context sensitive help

When the **ENTER** button is pressed with the last digit highlighted, the confirmation screen (described previously) is displayed. If 'Yes' is selected, the edit value is persisted as the new value for the Sim Gas concentration value. Otherwise, the edit value is rejected. In either case, the menu returns to the Override sub-menu menu with the 'Sim Gas' menu item selected.

Selected 'Exit' from the 'Override' sub-menu returns the user to the sensor's service menu with the 'Override' menu item selected.

5.4.2 LED/Relay Activation Test

The UTx-M Service Menu allows the activation of all relays and LEDs, regardless of alarm state. This may be useful during system configuration to verify operation of the LEDs and relays, as well as to verify that the polarity settings are correct.

From the UTx service menu, selecting 'Test' will update the display to show the following:



- ← 'Test' serves as a label only, therefore, this item can not be selected.
- ← Defaults to the current value of the test enable flag. Use UP/DOWN arrow buttons to toggle between Disabled and Enabled. Press ENTER button to confirm selection.
- ← Context sensitive help

When the **ENTER** button is pressed, the confirmation screen (described previously) is displayed.

In addition to activating all relays (taking into account polarity settings), all display and sensor LEDs will appear SOLID WHITE, if functional.



6. Modbus

6.1 Register Set

Register	Description	Bytes	R/W
0	Hardware Type / Hardware Version	2	R
256	Sensor A Reserved / Alarm Config 1 Relays	2	R
257	Sensor A Alarm Config 2 Relays / Alarm Config 3 Relays	2	R
258	Sensor B Reserved / Alarm Config 1 Relays	2	R
259	Sensor B Alarm Config 2 Relays / Alarm Config 3 Relays	2	R
260	Sensor C Reserved / Alarm Config 1 Relays	2	R
261	Sensor C Alarm Config 2 Relays / Alarm Config 3 Relays	2	R
262	Sensor D Reserved / Alarm Config 1 Relays	2	R
263	Sensor D Alarm Config 2 Relays / Alarm Config 3 Relays	2	R
264	Sensor E Reserved / Alarm Config 1 Relays	2	R
265	Sensor E Alarm Config 2 Relays / Alarm Config 3 Relays	2	R
266	Sensor F Reserved / Alarm Config 1 Relays	2	R
267	Sensor F Alarm Config 2 Relays / Alarm Config 3 Relays	2	R
1024 - 1025	Sensor A Alarm Config 1 Threshold	4	R
1026	Sensor A Alarm Config 1 Act Delay	2	R
1027	Sensor A Alarm Config 1 Min Run	2	R
1028	Sensor A Alarm Config 1 Input / Level	2	R
1029	Sensor A Alarm Config 1 Type / Latching	2	R
1036 - 1037	Sensor A Alarm Config 2 Threshold	4	R
1038	Sensor A Alarm Config 2 Act Delay	2	R
1039	Sensor A Alarm Config 2 Min Run	2	R
1040	Sensor A Alarm Config 2 Input / Level	2	R
1041	Sensor A Alarm Config 2 Type / Latching	2	R
1048 - 1049	Sensor A Alarm Config 3 Threshold	4	R
1050	Sensor A Alarm Config 3 Act Delay	2	R
1051	Sensor A Alarm Config 3 Min Run	2	R
1052	Sensor A Alarm Config 3 Input / Level	2	R
1053	Sensor A Alarm Config 3 Type / Latching	2	R
1060 - 1061	Sensor A Hysteresis	4	R
1280 - 1281	Sensor B Alarm Config 1 Threshold	4	R
1282	Sensor B Alarm Config 1 Act Delay	2	R
1283	Sensor B Alarm Config 1 Min Run	2	R
1284	Sensor B Alarm Config 1 Input / Level	2	R



1285	Sensor B Alarm Config 1 Type / Latching	2	R
1292 - 1293	Sensor B Alarm Config 2 Threshold	4	R
1294	Sensor B Alarm Config 2 Act Delay	2	R
1295	Sensor B Alarm Config 2 Min Run	2	R
1296	Sensor B Alarm Config 2 Input / Level	2	R
1297	Sensor B Alarm Config 2 Type / Latching	2	R
1304 - 1305	Sensor B Alarm Config 3 Threshold	4	R
1306	Sensor B Alarm Config 3 Act Delay	2	R
1307	Sensor B Alarm Config 3 Min Run	2	R
1308	Sensor B Alarm Config 3 Input / Level	2	R
1309	Sensor B Alarm Config 3 Type / Latching	2	R
1316 - 1317	Sensor B Hysteresis	4	R
1536 - 1537	Sensor C Alarm Config 1 Threshold	4	R
1538	Sensor C Alarm Config 1 Act Delay	2	R
1539	Sensor C Alarm Config 1 Min Run	2	R
1540	Sensor C Alarm Config 1 Input / Level	2	R
1541	Sensor C Alarm Config 1 Type / Latching	2	R
1548 - 1549	Sensor C Alarm Config 2 Threshold	4	R
1550	Sensor C Alarm Config 2 Act Delay	2	R
1551	Sensor C Alarm Config 2 Min Run	2	R
1552	Sensor C Alarm Config 2 Input / Level	2	R
1553	Sensor C Alarm Config 2 Type / Latching	2	R
1560 - 1561	Sensor C Alarm Config 3 Threshold	4	R
1562	Sensor C Alarm Config 3 Act Delay	2	R
1563	Sensor C Alarm Config 3 Min Run	2	R
1564	Sensor C Alarm Config 3 Input / Level	2	R
1565	Sensor C Alarm Config 3 Type / Latching	2	R
1572 - 1573	Sensor C Hysteresis	4	R
1792 - 1793	Sensor D Alarm Config 1 Threshold	4	R
1794	Sensor D Alarm Config 1 Act Delay	2	R
1795	Sensor D Alarm Config 1 Min Run	2	R
1796	Sensor D Alarm Config 1 Input / Level	2	R
1797	Sensor D Alarm Config 1 Type / Latching	2	R
1804 - 1805	Sensor D Alarm Config 2 Threshold	4	R
1806	Sensor D Alarm Config 2 Act Delay	2	R
1807	Sensor D Alarm Config 2 Min Run	2	R
1808	Sensor D Alarm Config 2 Input / Level	2	R
1809	Sensor D Alarm Config 2 Type / Latching	2	R
1816 - 1817	Sensor D Alarm Config 3 Threshold	4	R
1818	Sensor D Alarm Config 3 Act Delay	2	R
1819	Sensor D Alarm Config 3 Min Run	2	R



1820	Sensor D Alarm Config 3 Input / Level	2	R
1821	Sensor D Alarm Config 3 Type / Latching	2	R
1828 - 1829	Sensor D Hysteresis	4	R
2048 - 2049	Sensor E Alarm Config 1 Threshold	4	R
2050	Sensor E Alarm Config 1 Act Delay	2	R
2051	Sensor E Alarm Config 1 Min Run	2	R
2052	Sensor E Alarm Config 1 Input / Level	2	R
2053	Sensor E Alarm Config 1 Type / Latching	2	R
2060 - 2061	Sensor E Alarm Config 2 Threshold	4	R
2062	Sensor E Alarm Config 2 Act Delay	2	R
2063	Sensor E Alarm Config 2 Min Run	2	R
2064	Sensor E Alarm Config 2 Input / Level	2	R
2065	Sensor E Alarm Config 2 Type / Latching	2	R
2072 - 2073	Sensor E Alarm Config 3 Threshold	4	R
2074	Sensor E Alarm Config 3 Act Delay	2	R
2075	Sensor E Alarm Config 3 Min Run	2	R
2076	Sensor E Alarm Config 3 Input / Level	2	R
2077	Sensor E Alarm Config 3 Type / Latching	2	R
2084 - 2085	Sensor E Hysteresis	4	R
2304 - 2305	Sensor F Alarm Config 1 Threshold	4	R
2306	Sensor F Alarm Config 1 Act Delay	2	R
2307	Sensor F Alarm Config 1 Min Run	2	R
2308	Sensor F Alarm Config 1 Input / Level	2	R
2309	Sensor F Alarm Config 1 Type / Latching	2	R
2316 - 2317	Sensor F Alarm Config 2 Threshold	4	R
2318	Sensor F Alarm Config 2 Act Delay	2	R
2319	Sensor F Alarm Config 2 Min Run	2	R
2320	Sensor F Alarm Config 2 Input / Level	2	R
2321	Sensor F Alarm Config 2 Type / Latching	2	R
2328 - 2329	Sensor F Alarm Config 3 Threshold	4	R
2330	Sensor F Alarm Config 3 Act Delay	2	R
2331	Sensor F Alarm Config 3 Min Run	2	R
2332	Sensor F Alarm Config 3 Input / Level	2	R
2333	Sensor F Alarm Config 3 Type / Latching	2	R
2340 - 2341	Sensor F Hysteresis	4	R
2560 - 2561	Sensor A Sensor Part	4	R
2562 - 2567	Sensor A Sensor Serial Number	12	R
2568 - 2571	Sensor A Sensor IPN	8	R
2572 - 2577	Sensor A Gas short name	12	R
2578 - 2587	Sensor A Gas long name	20	R
2588 - 2589	Sensor A Max gas concentration	4	R



2590 - 2591	Sensor A Min gas concentration	4	R
2592 - 2593	Sensor A Zero buffer	4	R
2594 - 2595	Sensor A Warm Up Value	4	R
2596 - 2597	Sensor A Last calibration timestamp	4	R
2598 - 2599	Sensor A Next calibration timestamp	4	R
2600	Sensor A Calibration Frequency / Cal Valid	2	R
2601	Sensor A Sensor Life Expectancy Months / Gas Type	2	R
2602	Sensor A Engineering Units / Warm Up Value Enable	2	R
2816 - 2817	Sensor B Sensor Part	4	R
2818 - 2823	Sensor B Sensor Serial Number	12	R
2824 - 2827	Sensor B Sensor IPN	8	R
2828 - 2833	Sensor B Gas short name	12	R
2834 - 2843	Sensor B Gas long name	20	R
2844 - 2845	Sensor B Max gas concentration	4	R
2846 - 2847	Sensor B Min gas concentration	4	R
2848 - 2849	Sensor B Zero buffer	4	R
2850 - 2851	Sensor B Warm Up Value	4	R
2852 - 2853	Sensor B Last calibration timestamp	4	R
2854 - 2855	Sensor B Next calibration timestamp	4	R
2856	Sensor B Calibration Frequency / Cal Valid	2	R
2857	Sensor B Sensor Life Expectancy Months / Gas Type	2	R
2858	Sensor B Engineering Units / Warm Up Value Enable	2	R
3072 - 3073	Sensor C Sensor Part	4	R
3074 - 3079	Sensor C Sensor Serial Number	12	R
3080 - 3083	Sensor C Sensor IPN	8	R
3084 - 3089	Sensor C Gas short name	12	R
3090 - 3099	Sensor C Gas long name	20	R
3100 - 3101	Sensor C Max gas concentration	4	R
3102 - 3103	Sensor C Min gas concentration	4	R
3104 - 3105	Sensor C Zero buffer	4	R
3106 - 3107	Sensor C Warm Up Value	4	R
3108 - 3109	Sensor C Last calibration timestamp	4	R
3110 - 3111	Sensor C Next calibration timestamp	4	R
3112	Sensor C Calibration Frequency / Cal Valid	2	R
3113	Sensor C Sensor Life Expectancy Months / Gas Type	2	R
3114	Sensor C Engineering Units / Warm Up Value Enable	2	R
3328 - 3329	Sensor D Sensor Part	4	R
3330 - 3335	Sensor D Sensor Serial Number	12	R
3336 - 3339	Sensor D Sensor IPN	8	R
3340 - 3345	Sensor D Gas short name	12	R
3346 - 3355	Sensor D Gas long name	20	R



3356 - 3357	Sensor D Max gas concentration	4	R
3358 - 3359	Sensor D Min gas concentration	4	R
3360 - 3361	Sensor D Zero buffer	4	R
3362 - 3363	Sensor D Warm Up Value	4	R
3364 - 3365	Sensor D Last calibration timestamp	4	R
3366 - 3367	Sensor D Next calibration timestamp	4	R
3368	Sensor D Calibration Frequency / Cal Valid	2	R
3369	Sensor D Sensor Life Expectancy Months / Gas Type	2	R
3370	Sensor D Engineering Units / Warm Up Value Enable	2	R
3584 - 3585	Sensor E Sensor Part	4	R
3586 - 3591	Sensor E Sensor Serial Number	12	R
3592 - 3595	Sensor E Sensor IPN	8	R
3596 - 3601	Sensor E Gas short name	12	R
3602 - 3611	Sensor E Gas long name	20	R
3612 - 3613	Sensor E Max gas concentration	4	R
3614 - 3615	Sensor E Min gas concentration	4	R
3616 - 3617	Sensor E Zero buffer	4	R
3618 - 3619	Sensor E Warm Up Value	4	R
3620 - 3621	Sensor E Last calibration timestamp	4	R
3622 - 3623	Sensor E Next calibration timestamp	4	R
3624	Sensor E Calibration Frequency / Cal Valid	2	R
3625	Sensor E Sensor Life Expectancy Months / Gas Type	2	R
3626	Sensor E Engineering Units / Warm Up Value Enable	2	R
3840 - 3841	Sensor F Sensor Part	4	R
3842 - 3847	Sensor F Sensor Serial Number	12	R
3848 - 3851	Sensor F Sensor IPN	8	R
3852 - 3857	Sensor F Gas short name	12	R
3858 - 3867	Sensor F Gas long name	20	R
3868 - 3869	Sensor F Max gas concentration	4	R
3870 - 3871	Sensor F Min gas concentration	4	R
3872 - 3873	Sensor F Zero buffer	4	R
3874 - 3875	Sensor F Warm Up Value	4	R
3876 - 3877	Sensor F Last calibration timestamp	4	R
3878 - 3879	Sensor F Next calibration timestamp	4	R
3880	Sensor F Calibration Frequency / Cal Valid	2	R
3881	Sensor F Sensor Life Expectancy Months / Gas Type	2	R
3882	Sensor F Engineering Units / Warm Up Value Enable	2	R
4128 - 4129	Analog 1 Voltage Fault	4	R/W
4130 - 4131	Analog 1 Current Fault	4	R/W
4134	Analog 1 Input Mode / Input Min	2	R/W
4135	Analog 1 Input Max / Output Mode	2	R/W



4136	Analog 1 Output Min / Output Max	2	R/W
4137	Analog 1 Sensor Output / Sensor Scale	2	R/W
4384 - 4385	Analog 2 Voltage Fault	4	R/W
4386 - 4387	Analog 2 Current Fault	4	R/W
4390	Analog 2 Input Mode / Input Min	2	R/W
4391	Analog 2 Input Max / Output Mode	2	R/W
4392	Analog 2 Output Min / Output Max	2	R/W
4393	Analog 2 Sensor Output / Sensor Scale	2	R/W
4608 - 4609	Current Time	4	R
4876 - 4877	RTC Battery Voltage	4	R
5653	Relay Control / Relay Output	2	R
7936 - 7937	Sensor A Gas Override	4	R
7939	Sensor A Reserved / Enable Override	2	R
7940 - 7941	Sensor B Gas Override	4	R
7943	Sensor B Reserved / Enable Override	2	R
7944 - 7945	Sensor C Gas Override	4	R
7947	Sensor C Reserved / Enable Override	2	R
7948 - 7949	Sensor D Gas Override	4	R
7951	Sensor D Reserved / Enable Override	2	R
7952 - 7953	Sensor E Gas Override	4	R
7955	Sensor E Reserved / Enable Override	2	R
7956 - 7957	Sensor F Gas Override	4	R
7959	Sensor F Reserved / Enable Override	2	R
9472 - 9473	Sensor A Reading	4	R
9474	Sensor A Change Detected Bit / Sensor State (MSB) / Alarm Status (LSB)	2	R
9476 - 9477	Sensor B Reading	4	R
9478	Sensor B Sensor State (MSB) / Alarm Status (LSB)	2	R
9480 - 9481	Sensor C Reading	4	R
9482	Sensor C Sensor State (MSB) / Alarm Status (LSB)	2	R
9484 - 9485	Sensor D Reading	4	R
9486	Sensor D Sensor State (MSB) / Alarm Status (LSB)	2	R
9488 - 9489	Sensor E Reading	4	R
9490	Sensor E Sensor State (MSB) / Alarm Status (LSB)	2	R
9492 - 9493	Sensor F Reading	4	R
9494	Sensor F Sensor State (MSB) / Alarm Status (LSB)	2	R
9496 - 9498	Change Notification	6	R/W
9499 - 9501	Change Notification Mask	6	R/W
9502	Local (MSB) / External (LSB) sensor count	2	R
9503	Relay Command	2	R/W
9522 - 9523	Bus Sense	4	R
9992 - 9993	Sensor A Fifteen Minute Average	4	R



9994 - 9995	Sensor A Eight hour average	4	R
9998 - 9999	Sensor A Daily Peak	4	R
10000	Sensor A 15-min Valid / 8-hr Valid	2	R
10001	Sensor A Daily Valid / Reserved	2	R
10002	Sensor A Temperature (Celsius)	2	R
10003	Sensor A Reserved / Relative humidity (%RH)	2	R
10004 - 10005	Sensor A Pressure (Pa)	4	R
10248 - 10249	Sensor B Fifteen Minute Average	4	R
10250 - 10251	Sensor B Eight hour average	4	R
10254 - 10255	Sensor B Daily Peak	4	R
10256	Sensor B 15-min Valid / 8-hr Valid	2	R
10257	Sensor B Daily Valid / Reserved	2	R
10258	Sensor B Temperature (Celsius)	2	R
10259	Sensor B Reserved / Relative humidity (%RH)	2	R
10260 - 10261	Sensor B Pressure (Pa)	4	R
10504 - 10505	Sensor C Fifteen Minute Average	4	R
10506 - 10507	Sensor C Eight hour average	4	R
10510 - 10511	Sensor C Daily Peak	4	R
10512	Sensor C 15-min Valid / 8-hr Valid	2	R
10513	Sensor C Daily Valid / Reserved	2	R
10514	Sensor C Temperature (Celsius)	2	R
10515	Sensor C Reserved / Relative humidity (%RH)	2	R
10516 - 10517	Sensor C Pressure (Pa)	4	R
10760 - 10761	Sensor D Fifteen Minute Average	4	R
10762 - 10763	Sensor D Eight hour average	4	R
10766 - 10767	Sensor D Daily Peak	4	R
10768	Sensor D 15-min Valid / 8-hr Valid	2	R
10769	Sensor D Daily Valid / Reserved	2	R
10770	Sensor D Temperature (Celsius)	2	R
10771	Sensor D Reserved / Relative humidity (%RH)	2	R
10772 - 10773	Sensor D Pressure (Pa)	4	R
11016 - 11017	Sensor E Fifteen Minute Average	4	R
11018 - 11019	Sensor E Eight hour average	4	R
11022 - 11023	Sensor E Daily Peak	4	R
11024	Sensor E 15-min Valid / 8-hr Valid	2	R
11025	Sensor E Daily Valid / Reserved	2	R
11026	Sensor E Temperature (Celsius)	2	R
11027	Sensor E Reserved / Relative humidity (%RH)	2	R
11028 - 11029	Sensor E Pressure (Pa)	4	R
11272 - 11273	Sensor F Fifteen Minute Average	4	R
11274 - 11275	Sensor F Eight hour average	4	R



11278 - 11279	Sensor F Daily Peak	4	R
11280	Sensor F 15-min Valid / 8-hr Valid	2	R
11281	Sensor F Daily Valid / Reserved	2	R
11282	Sensor F Temperature (Celsius)	2	R
11283	Sensor F Reserved / Relative humidity (%RH)	2	R
11284 - 11285	Sensor F Pressure (Pa)	4	R
13318	Transmitter Firmware Major / Minor Version	2	R

- When writing to an R/W register, it is the responsibility of the writing device to provide valid register values.
- Sensor A-F Alarm Config 1-3 Threshold: "Threshold" refers to the alarm setpoint value.
- Sensor A-F Calibration Frequency / Cal Valid: "Cal Valid" returns 0xFF at present.
- Current Time: Seconds since January 1, 1970.

6.2 Analog Config

When writing to registers on the UTx-M, it is the responsibility of the master device to write valid values.

- Voltage Fault: 0-10V. Note that a value of 0V will disable the input fault check. A value less than Input Min is typically chosen.
- Current Fault: 0-20mA. Note that a value of 0mA will disable the input fault check. A value less than Input Min is typically chosen.
- Input Mode: 0 (current), 1 (voltage), and 2 (multidrop)
- Input Min: 0mA or 0V.
- Input Max: 20mA or 10V
- Output Mode: 0 (current), and 1 (voltage)
- Output Min: 0mA or 0V
- Output Max: 20mA or 10V
- Sensor Output: A bitmask between 0b00000000 and 0b00111111. Position 0 is sensor A and position 5 is sensor F. Whichever of the selected sensors has a highest percent of max gas concentration will drive the analog output. See "Outputs" section for more details.
- Sensor Scale: A bitmask between 0b00000000 and 0b00111111. Position 0 is sensor A and position 5 is sensor F. When a sensor has its sensor scale bit set, the high alarm (setpoint 3) is used in place of the max gas concentration when determining the highest percent of max gas for multiplexing. See "Outputs" section for more details.

6.3 Relay control

There are two registers that can be used to interact with the local relay and relay drivers 1-5 via MODBUS.

The "Relay Control / Relay Output" register contains two byte-sized bitmasks that indicate the present state of the relays. "Relay Control" indicates which relays are being affected by an alarm level.

"Relay Output" indicates the state of the relays, including the effects of relay polarity, and relay command.

The "Relay Command" register is a writable bitmask that indicates which relays to toggle. Note that a relay cannot be turned off over MODBUS if the transmitter has activated the relay itself, for example, due to an alarm.

The Local relay is bit 0, and Relay 1-5 are bits 1-5 respectively.

6.4 Change Notification System

The change notification system provides a mechanism to indicate when there are certain changes at the transmitter that a monitor may want to track. These include changing values through interaction with the menu system, if the corresponding values are available in the register set.

The first two change notification registers form a 31-bit bitmask indicating which EEPROM tables were affected by a change. The following table maps the EEPROM table to its bitmask position:

Table Name	Bit Position
Device Config	1
Sensor Alarms A	4
Sensor Alarms B	5
Sensor Alarms C	6
Sensor Alarms D	7
Sensor Alarms E	8
Sensor Alarms F	9
Sensor Meta A	10
Sensor Meta B	11
Sensor Meta C	12
Sensor Meta D	13
Sensor Meta E	14
Sensor Meta F	15
Analog Config 1	16
Analog Config 2	17



The third change notification register is not EEPROM related, but indicate special transmitter conditions. At present, only the bit position 0 in this register is in use, and indicates that the transmitter just reset or powered up.

If any change notification register has any bits set, the most significant bit will be set in the "Sensor A Change Detected Bit / Sensor State (MSB) / Alarm Status (LSB)" register. If a monitor detects that the change detected bit is set, the change notification registers can then be read to determine if which registers should to be re-fetched. Once the registers are re-fetched, the monitor then needs to clear the change notification registers.

Finally, the "Change Notification Mask" provide a mechanism to tell the transmitter to ignore certain menu changes when updating the change notification registers. By default, every bit of these masks is set so that no change is ignored.

Example:

1. A user updates the configured alarm relays through the "Output" menu item (Device Config table).
2. The user also updates the sensor B zero buffer through the menu system. The change notification registers bits 1 and 11 would normally be set.
However, the monitor previously cleared bit 1 of the change notification mask registers, and thus only bit 11 is set.
3. Upon the next read of "Sensor A Change Detected Bit / Sensor State (MSB) / Alarm Status (LSB)" the monitor detects that the most significant bit is set.
4. The monitor then requests the Sensor Meta B registers to get the up-to-date data.
5. The monitor follows by clearing the change notification registers.
6. Upon the subsequent read of "Sensor A Change Detected Bit / Sensor State (MSB) / Alarm Status (LSB)" the change detected bit is once again reads 0.

7. Troubleshooting

7.1 Symptoms and Corrective Actions

Table 7-1: Troubleshooting Table

Symptom	Possible Cause	How to Verify	Corrective Action
UTx-M Gas Reading Does Not Show Up on 1DCX Monitor.	Incorrect Modbus Address specified in either the Monitor or the UTx-M	Monitor shows UTx-M Gas Sensor Missing.	Enter password, enter UTx-M service menu and correct MODBUS address for sensor.
	Duplicate Modbus Address on two or more devices on MODBUS Network	Monitor shows UTx-M Gas Sensor Missing. UTx with same MODBUS address show slow-blinking GREEN Network LED (Solid GREEN v5.7+) while other UTx units on network detect Network Fault by turning their Network LED RED.	Enter password, enter UTx-M menu and correct MODBUS address for sensor.
	Incorrect Device or gas type specified in the Digital Monitor	Monitor shows gas mismatch by turning off its GREEN System LED. Check monitor's system status in "Get System Info" dialog.	Change monitor's configuration to match Sensor Module gas and MODBUS address settings. Ensure MODBUS addresses are matching for assignment S1 and S2.
	Incorrect Parity	UTx-M shows RED on Network LED.	Monitor's MODBUS interface is set to EVEN/ODD/NONE parity. Change UTx-M parity to match Monitor's parity.
	Incorrect Baud Rate Selected	UTx-M shows RED on Network LED.	Monitor's MODBUS interface is set to 9600 Baud.



	Incorrect RS485 A/B Connections	UTx-M shows RED on Network LED.	Change wiring to flip A/B configuration.
	Not Connected to MODBUS Network	UTx-M shows blinking GREEN on Network LED.	Check wiring or connect UTx-M to MODBUS network.
Monitor's RS485 Information has Timeouts or Communication Errors.	End of Line Termination on MODBUS	UTx devices flash RED on Network LEDs from time to time.	Ensure last UTx unit on MODBUS network has EOL switched in on position and EOL LED in lit on that unit.
	Multiple End of Line Terminations on MODBUS Network Segment are Installed	UTx devices flash RED on Network LEDs from time to time.	Ensure only end UTx unit on MODBUS segment has EOL switched in the on position and only one EOL LED is lit on Network segment. Ensure Monitor's EOL termination is installed if monitor is at end of network segment.
No Gas Concentration on UTx-M Display.	Sensor Module Not Connected or Broken Loose Wire to Sensor Module	No Sensor Module LED. Sensor LED RED.	Check wiring from UTx-M Module to Sensor Module.
Only one Gas Concentration Bar on UTx-M Display.	Second Sensor Module Not Connected or Broken Loose Wire to Second Sensor Module	No Sensor Module LED. Sensor LED RED.	Check wiring from first Sensor Module to second Sensor Module.
	Not a Dual Sensor Module	Sensor LED RED.	Check if Sensor Module has dual sensors or correct type.
Local Relay Not Activating.	Configuration Incorrect	No Continuity Between COM and NO Bus Module Terminals.	Check Local Relay is selected in UTx service menu -> Alarms-> Alarm X -> Output.
Unable to enter ADAPTiCal menu item.	Sensor in warm-up due to power on or	Alarm LED is white. Sensor module in	Warm-up period will last a maximum of 300 seconds. Display will



	recovering post-calibration attempt.	warm-up also has white LED.	indicate countdown. ADAPTiCal is not operational/accessible until countdown has finished.
	Temperature Sensor Failure.	Alarm LED is green.	Contact Armstrong Monitoring for technical support.



8. Sensor Module Default Settings

8.1 Default Alarm Settings

Table 8-1: Default Alarm Settings

SM Code	Short Gas Name	Long Gas Name	Set Point 1	Set Point 2	Set Point 3	Engineering Units
			Increasing	Increasing	Increasing	
91A	CO	Carbon Monoxide	25	100	100	PPM
98A	NO ₂	Nitrogen Dioxide	1	3	3	PPM
VCA	CO	Carbon Monoxide	25	100	100	PPM
	NO ₂	Nitrogen Dioxide	1	3	3	PPM
VCB	CO	Carbon Monoxide	25	100	200	PPM
	NO ₂	Nitrogen Dioxide	1	3	3	PPM
60A	CH ₄	Methane	20	40	80	% LEL
61A	C ₃ H ₈	Propane	20	40	80	% LEL
62A	H ₂	Hydrogen	20	40	80	% LEL
			Decreasing	Decreasing	Decreasing	
70A	O ₂	Oxygen	19.5	17	17	% VOL



8.2 Default Sensor Module Settings

Table 8-2: Default Sensor Module Settings

SM Code	Short Gas Name	Long Gas Name	Span	Hysteresis	Zero Blanking	Engineering Units
91A	CO	Carbon Monoxide	100	2.50	+/- 5.0	PPM
91B	CO	Carbon Monoxide	300	2.50	+/- 5.0	PPM
98	NO ₂	Nitrogen Dioxide	10	0.25	+/- 0.5	PPM
VCA	CO	Carbon Monoxide	100	2.50	+/- 5.0	PPM
	NO ₂	Nitrogen Dioxide	10	0.25	+/- 0.5	PPM
VCB	CO	Carbon Monoxide	300	2.50	+/- 5.0	PPM
	NO ₂	Nitrogen Dioxide	10	0.25	+/- 0.5	PPM
60A	CH ₄	Methane	100	2.50	+/- 5.0	% LEL
61A	C ₃ H ₈	Propane	100	2.50	+/- 5.0	% LEL
62A	H ₂	Hydrogen	100	2.50	+/- 5.0	% LEL
70A	O ₂	Oxygen	25	0.625	+/- 1.25	% VOL

9. Menu Flow Diagrams

9.1 Main Screen / Password Flow

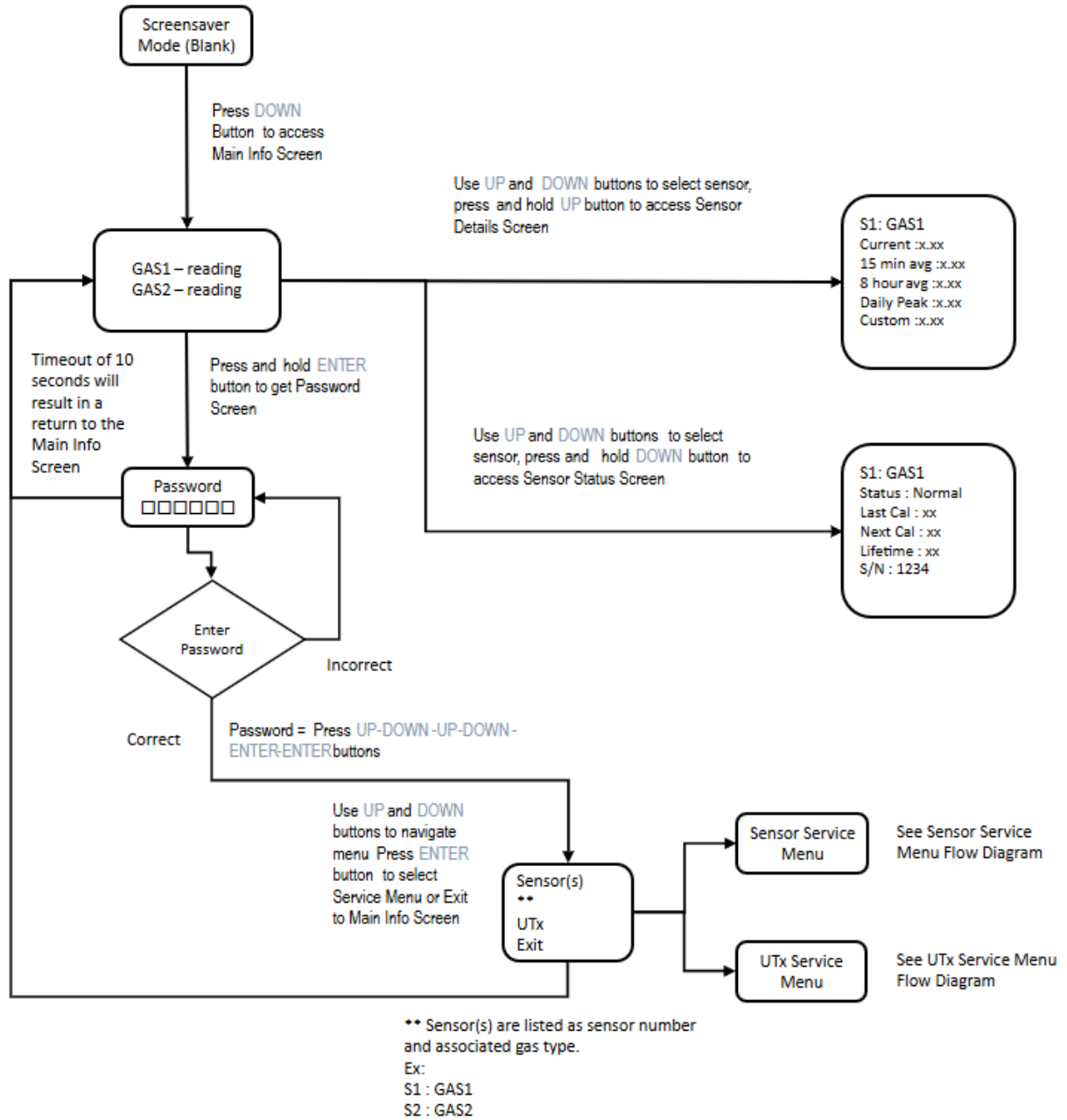

Figure 9-1: Main Screen / Password Flow Diagram

9.2 UTx Service Menu

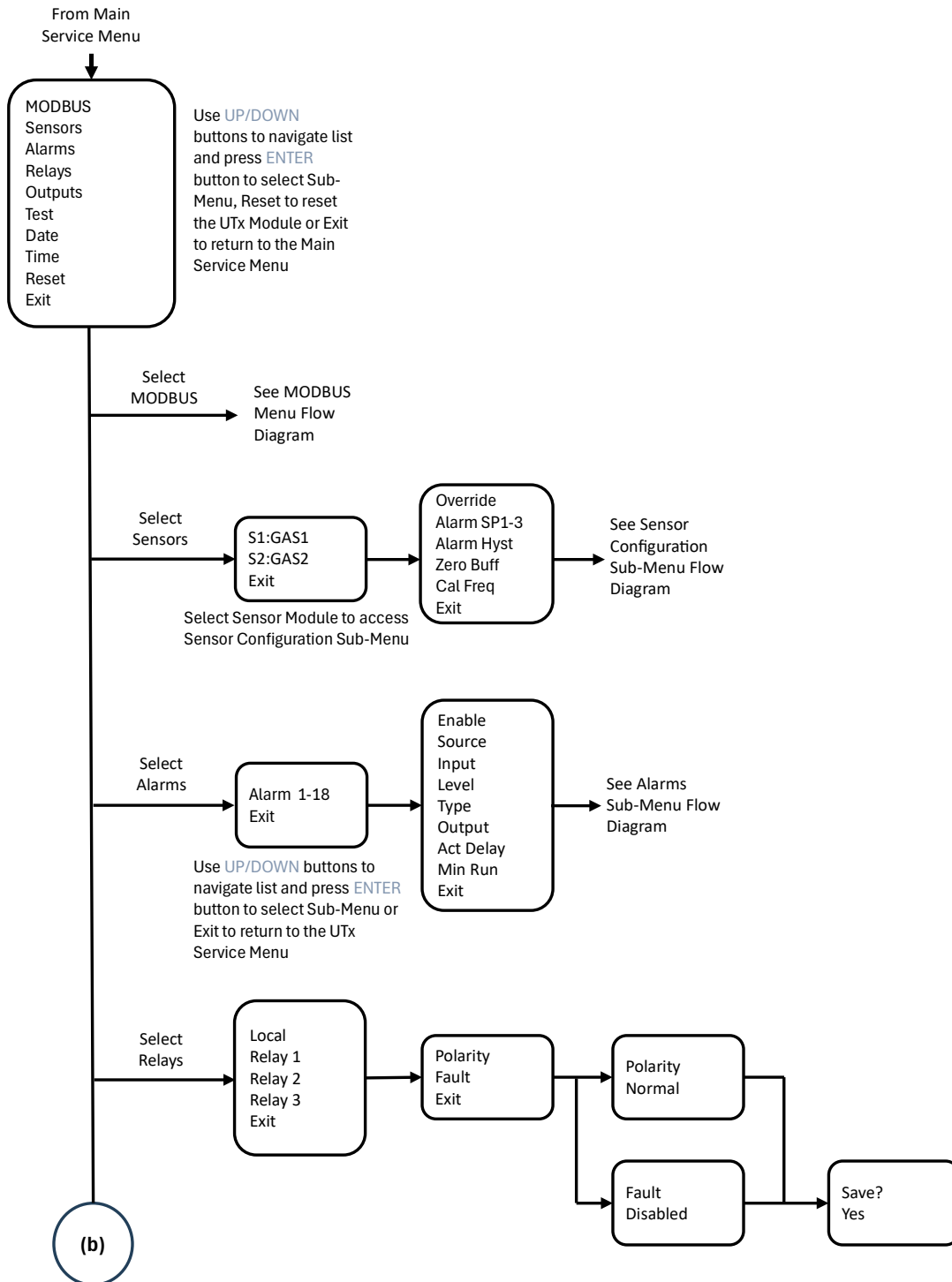

Figure 9-2: UTx Service Menu Flow Diagram (a)

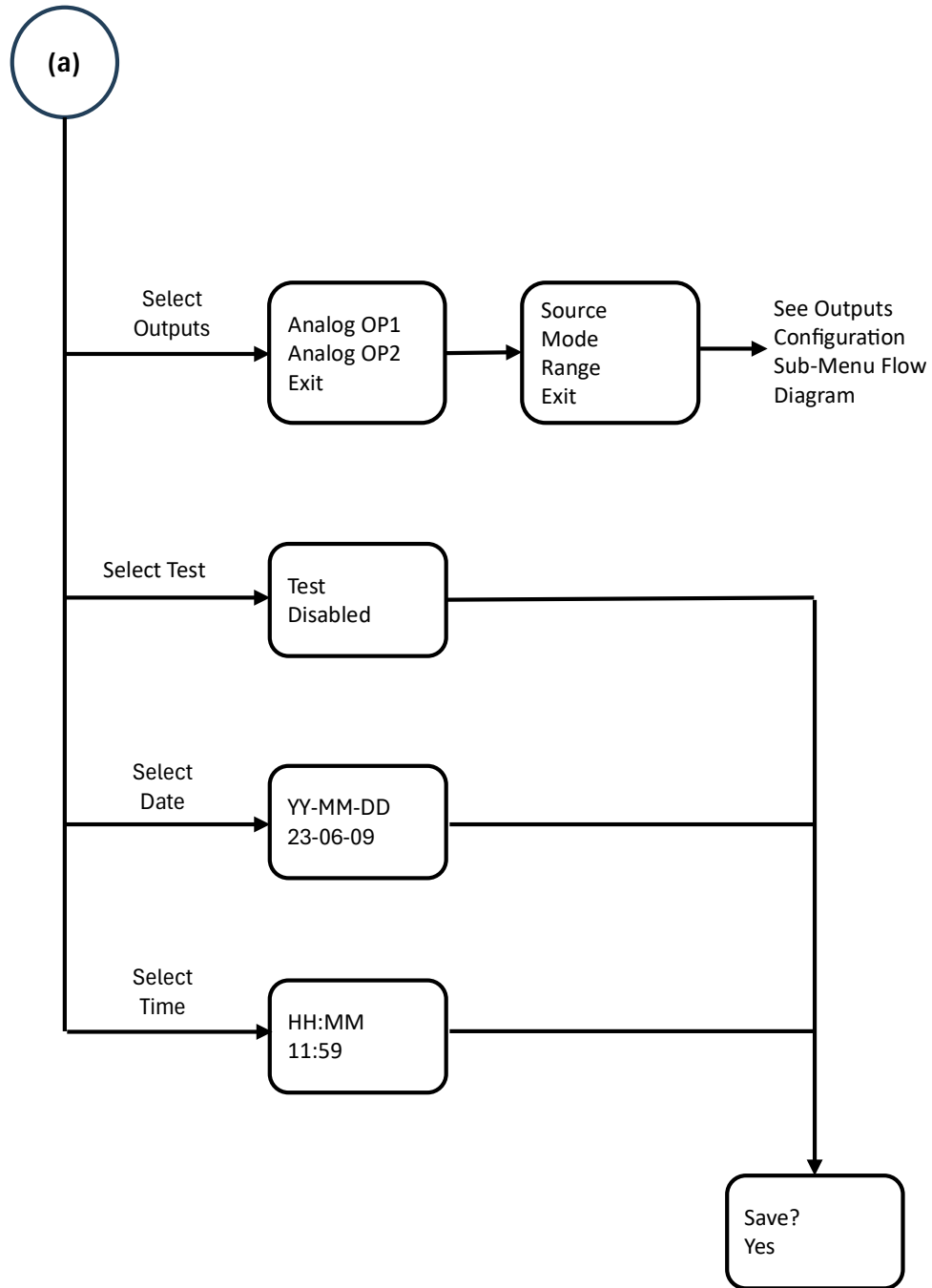

Figure 9-3: UTx Service Menu Flow Diagram (b)

9.3 Modbus Menu

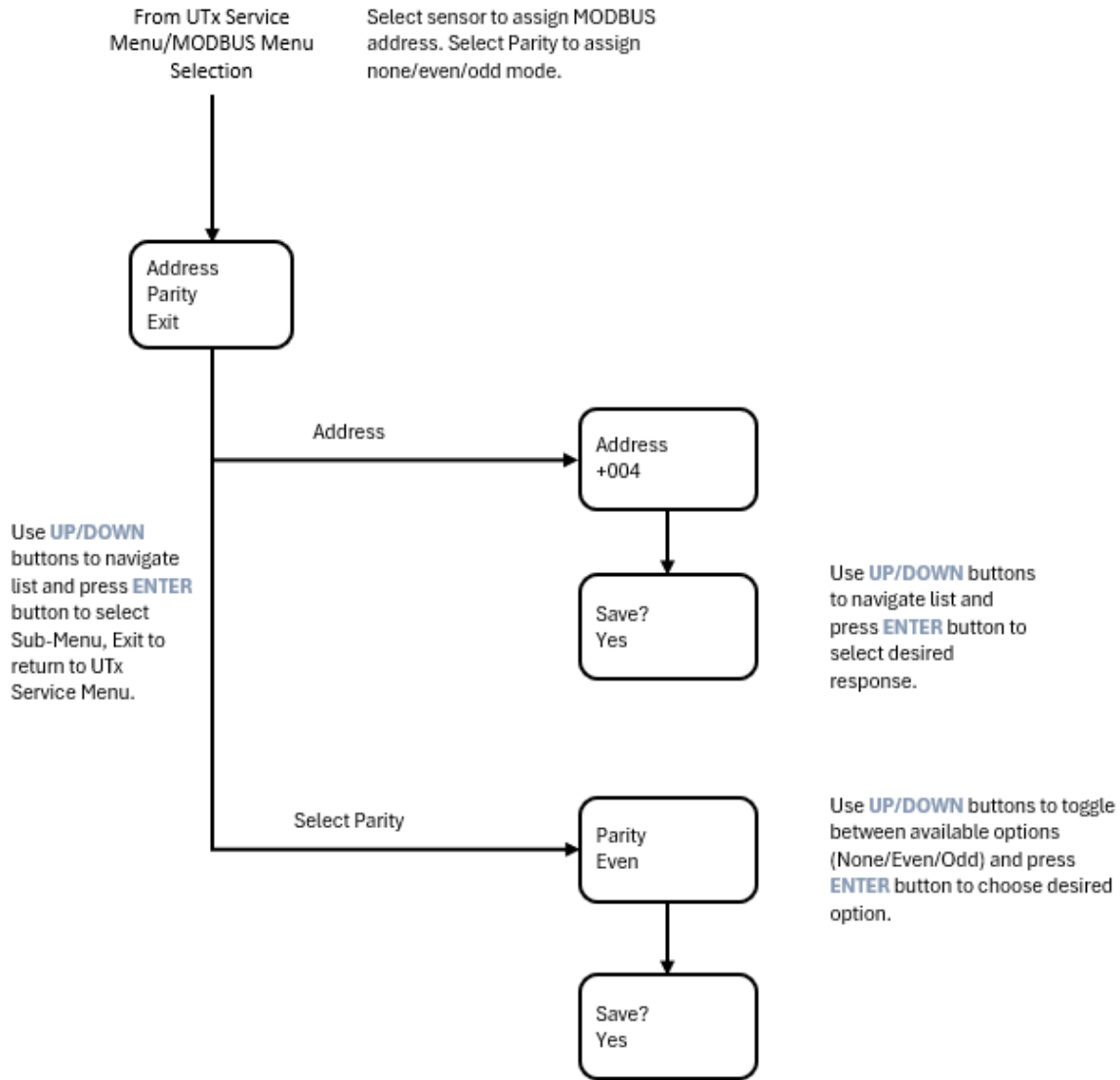

Figure 9-4: Modbus Menu Flow Diagram

9.4 Sensor Service Menu

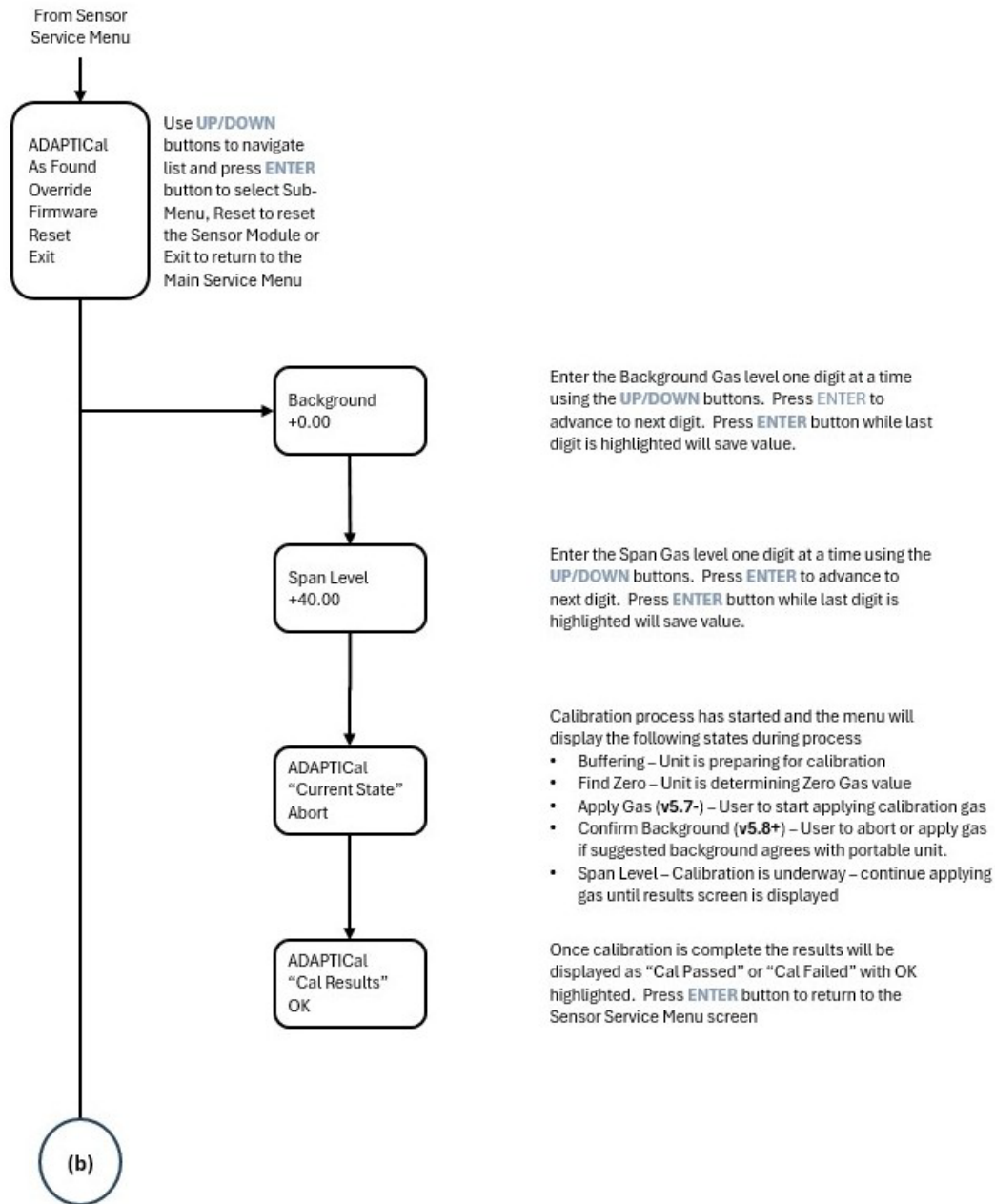

Figure 9-5: Sensor Service Menu Flow Diagram (a)

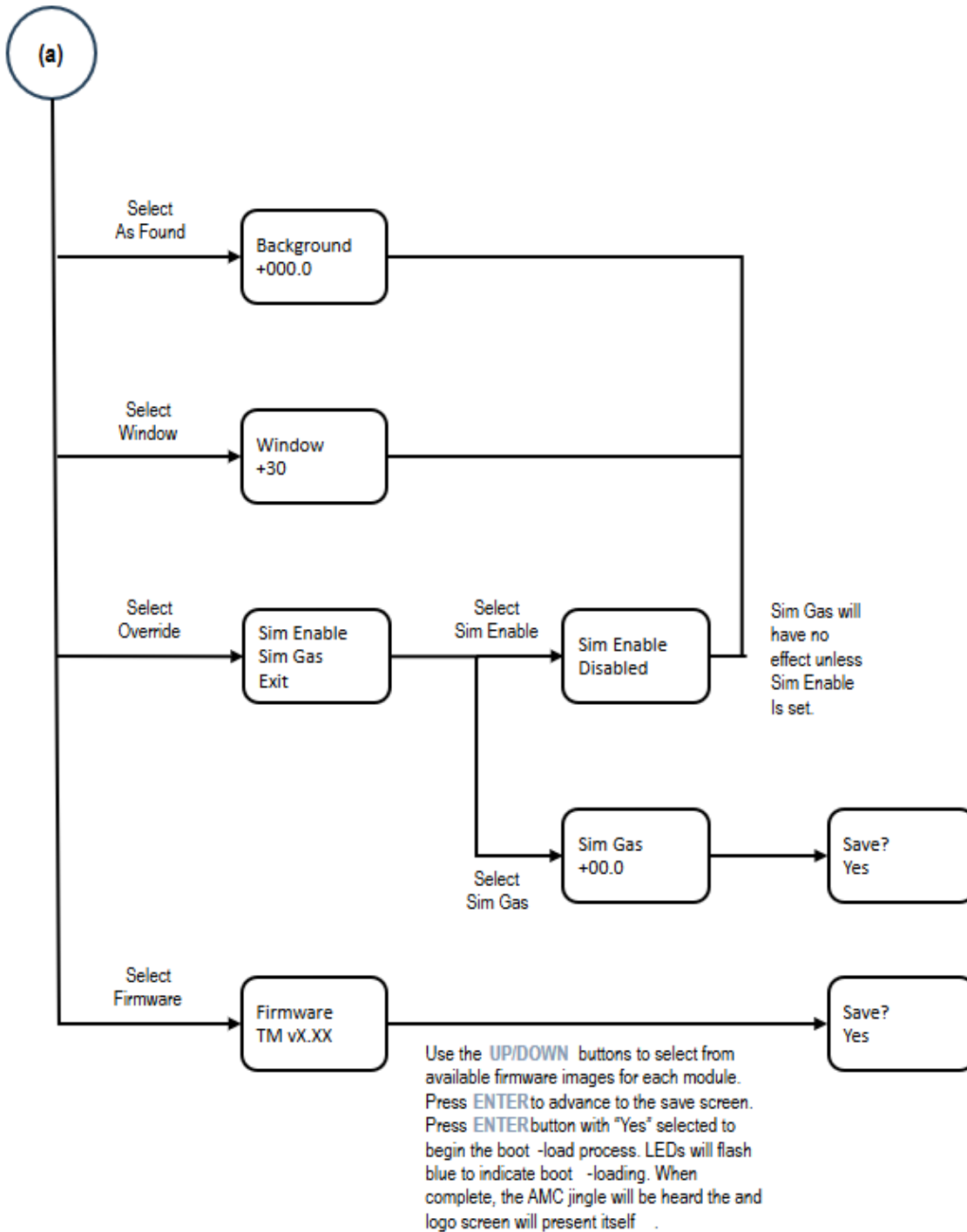

Figure 9-6: Sensor Service Menu Flow Diagram (b)

9.5 Sensor Configuration Menu

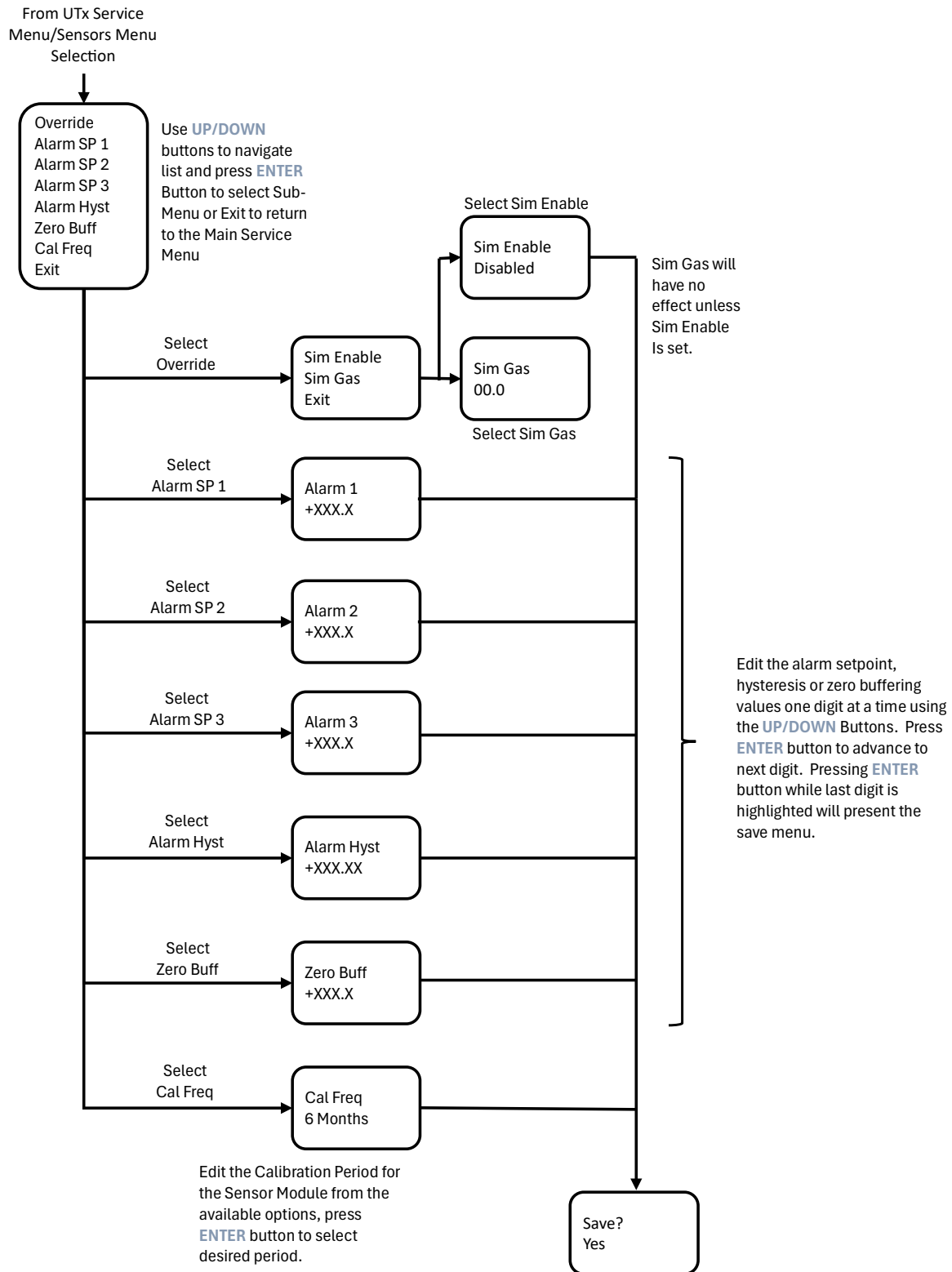

Figure 9-7: Sensor Configuration Menu Flow Diagram

9.6 Alarm Menu

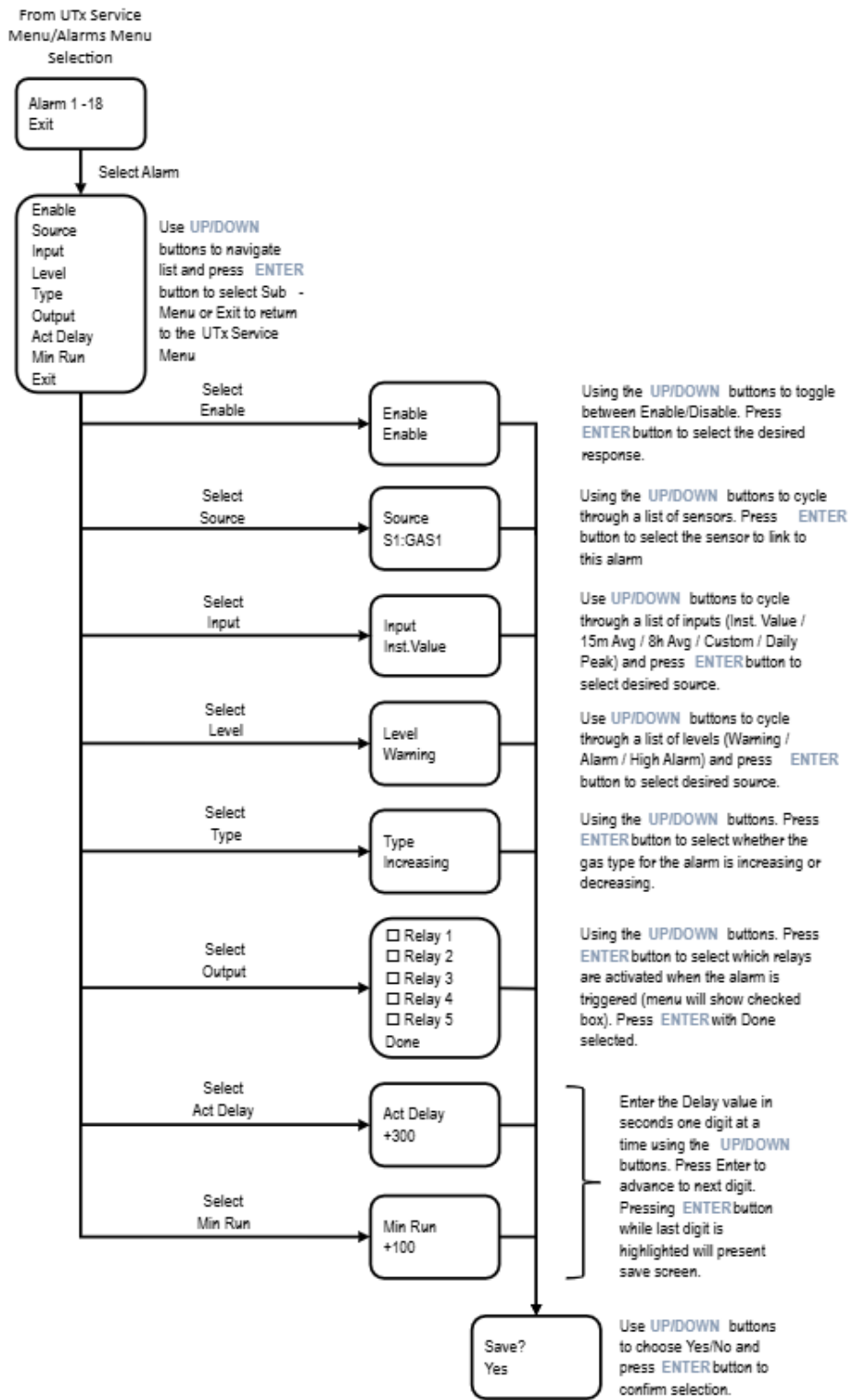

Figure 9-8: Alarm Menu Flow Diagram



10. Revision History

10.1 Document Revision History

Revision	Release Date	Change Description
A	December 2025	Initial Release
B	March 2026	Corrections to trouble-shooting section. Corrections to menu-flow diagrams.