



AMC-1BZ Series

Gas Monitor

USER MANUAL



3550412B

Copyright © 2026 AMC

The Armstrong Monitoring Corporation

215 Colonnade Road South, Ottawa, Ontario, Canada K2E 7K3

Tel: (613) 225 9531 • Fax: (613) 225 6965 • Canada & U.S. Toll Free: 1 (800) 465 5777

Email: support@armstrongmonitoring.com • Website: www.armstrongmonitoring.com



1	General Information	7
1.1	Warranty	7
1.2	Liability	7
1.3	Product Return	7
1.4	Contact Information	7
1.5	Modifications and Substitutions	8
1.6	Glossary	8
2	Product Specifications	9
2.1	AMC-1BZ Monitor	9
2.2	Product Description	10
2.3	External View	11
2.4	Internal View	12
3	Installation	13
3.1	Overview	13
3.2	Monitor Mounting	13
3.3	Wiring	15
3.3.1	Power Supply	15
3.3.2	Relays	15
3.3.3	Analog In (AMC-122x Sensor Modules)	16
3.3.4	Analog Out	16
3.3.5	RAM-3	17
4	Operation	18
4.1	Overview	18
4.2	Status LEDs	18
4.2.1	Start Up	18
4.2.2	Network Status	18
4.2.3	Faults	19
4.2.4	Alarms	19
4.2.5	Calibration	19
4.2.6	Miscellaneous	20
4.3	Menu Overview	20



AMC-1BZx Gas Monitor

4.3.1	Normal Operation	20
4.3.2	Failed Sensor	21
4.3.3	Warning/Alarm Indication	21
4.3.4	Fault Indication	23
4.3.5	Detailed Sensor Screen	23
4.3.6	Detailed Status Screen	24
4.3.7	Quick Info Screen	24
4.3.8	Password Entry	25
4.3.9	Main Service Menu	25
4.3.9.1	Service Menu Timeout	25
4.3.9.2	Service Menu Overview	26
4.3.10	External Sensor Service Menu	27
4.3.10.1	External Sensor Service Menu Overview	27
4.3.10.2	Analog Sub-Menu	27
4.3.10.3	Sensor Sub-Menu	29
4.3.10.4	Gas Label	30
4.3.10.5	Engineering Units	30
4.3.10.6	Simulation Of Gas Levels (External Sensors)	31
4.3.10.7	Override	31
4.3.10.8	Sim Enable	31
4.3.10.9	Sim Gas	32
4.3.11	Transmitter Service Menu	33
4.3.11.1	Transmitter Sensors Settings	33
4.3.11.2	Sensor Alarm Configuration Sub-Menu	34
4.3.11.3	Transmitter Alarms Settings	37
4.3.11.4	Alarm Sub-Menu	39
4.3.11.5	Transmitter Relay Settings	43
4.3.11.6	Outputs	45
4.3.11.7	Buzzer	48
4.3.11.8	Acknowledgement Timer	49
4.3.11.9	RTC Date & Time	49



5	Maintenance	50
5.1	General	50
5.2	Verification of Operation	50
5.2.1	LED/Relay Activation Test	50
6	Troubleshooting	51
6.1	Symptoms and Corrective Actions	51
7	Menu Flow Diagrams	52
7.1	Main Screen / Password Flow	52
7.2	UTx Service Menu	53
7.3	Sensor Service Menu	55
7.4	Alarm Menu	57
7.5	Outputs	58
8	Revision History	59
8.1	Document Revision History	59



List of Figures

Figure 2-1: External View11
Figure 2-2: Internal View.....12
Figure 3-1: Enclosure Mounting.....14
Figure 3-2: Relay Connections15
Figure 7-1: Main Screen / Password Flow.....52
Figure 7-2: UTx Service Menu (a)53
Figure 7-3: UTx Service Menu (b).....54
Figure 7-4: Sensor Service Menu Diagram (a)55
Figure 7-5: Sensor Service Menu Diagram (b)56
Figure 7-6: Alarm Menu Flow Diagram.....57
Figure 7-7: Outputs Menu Flow Diagram.....58



List of Tables

Table 4-1: Status LEDs (Start Up)	18
Table 4-2: Status LEDs (Network Status)	18
Table 4-3: Status LEDs (Faults)	19
Table 4-4: Status LEDs (Alarms).....	19
Table 4-5: Status LEDs (Calibration).....	19
Table 4-6: Status LEDs (Miscellaneous)	20
Table 4-7: Service Menu Options.....	26
Table 4-8: External Sensor Menu Options	27
Table 4-9: Analog Sub-Menu Options	28
Table 4-10: Sensor Sub-Menu Options	29
Table 4-11: Engineering Unit Options	30
Table 4-12: External Override Sub-Menu Options.....	31
Table 4-13: Transmitter Service Menu.....	33
Table 4-14: Sensor Module Configuration Menu.....	33
Table 4-15: Sensor Alarm Configuration	34
Table 4-16: Calibration Frequency Configuration	37
Table 4-17: Transmitter Alarm Settings	38
Table 4-18: Transmitter Alarm Sub-Menu Settings	39
Table 4-19: Alarm Input Options.....	40
Table 4-20: Alarm Setpoint Options	41
Table 4-21: Outputs Sub-Menu	45
Table 4-22: Buzzer Menu	48
Table 6-1: Troubleshooting.....	51
Table 8-1: Document Revision History.....	59



1 General Information

1.1 Warranty

This product is warranted against defects in material and workmanship for a period of two years from date of delivery. Maintenance items are not warranted. During the warranty period, *The Armstrong Monitoring Corporation* will repair or replace components that prove to be defective in the opinion of AMC. Any equipment deemed to be defective by the user should be returned to *The Armstrong Monitoring Corporation* for evaluation (see product return below). Site visits by Armstrong personnel, to evaluate/repair equipment, are not covered by this warranty unless covered under the site contract. AMC is not liable for auxiliary interfaced equipment, nor for consequential damage. This warranty shall not apply to any product which has been modified in any way, which has been repaired by any other party other than a qualified technician or authorized AMC representative, or when failure is due to misuse or conditions of use.

Note: Extended Warranty and mail in calibration programs are available (please call 1-800-465-5777) or see our contacts page at www.armstrongmonitoring.com

1.2 Liability

All AMC products must be installed and maintained according to instructions. Only qualified personnel should install and maintain the equipment. This product must not be placed in areas with combustible gases reaching 100% LEL (environments prone to explosions).

AMC shall have no liability arising from auxiliary interfaced equipment, for consequential damage, or the installation and operation of this equipment. AMC shall have no liability for labor or freight costs, or any other costs or charges in excess of the amount of the invoice for the products.

THIS WARRANTY IS IN LIEU OF ALL OTHER WARRANTIES, EXPRESSED OR IMPLIED AND SPECIFICALLY THE WARRANTIES OF MERCHANTABILITY AND FITNESS FOR A PARTICULAR PURPOSE. THERE ARE NO WARRANTIES THAT EXTEND BEYOND THE DESCRIPTION ON THE FACE THEREOF.

1.3 Product Return

All products returned for warranty or service should be shipped by prepaid freight and will be accepted only with RMA or repair number issued by AMC.

1.4 Contact Information

For information, please call 1-800-465-5777, visit www.armstrongmonitoring.com or email directly support@armstrongmonitoring.com.



1.5 Modifications and Substitutions

Due to an ongoing development program, AMC reserves the right to substitute components and change specifications at any time without incurring any obligations.

1.6 Glossary

Act Delay	The delay in seconds between the gas concentration reaching an alarm setpoint, and the corresponding alarm level activating.
Alarm	Alarm is an audible, visual, or physical presentation designed to warn the instrument user that a specific level of a dangerous gas/vapor concentration has been reached or exceeded.
Calibration	Calibration is the procedure used to adjust the instrument for proper response.
Calibration Gas	Calibration Gas is a gas of known concentration used in adjusting and testing gas detection equipment to ensure proper function and accurate readings.
Gas Concentration	Gas Concentration can be measured in: <ul style="list-style-type: none">• ppm• %LEL• % Volume
Hysteresis	A user-set difference from an alarm's setpoint prevents frequent alarm activation. Hysteresis solely impacts alarm deactivation, not its activation tied to the setpoint.
LEL	Lower Explosive Limit is the lowest concentration (percentage) of a gas or a vapor in air capable of combusting in the presence of an ignition source (arc, flame, heat).
Min Run	The minimum time in seconds that an alarm state will remain active, even if the gas concentration has returned above/below the setpoint +/- hysteresis (based on a decreasing or increasing alarm type).
ppm	Parts Per Million (1% volume = 10,000ppm)
Percent by Volume	Concentration of gas in a mixture expressed as a percentage of total volume.
Span	The difference between the highest concentration and lowest concentration.
T90	Response Time in seconds to achieve 90% gas concentration reading.
T99	Response Time in seconds to achieve 99% gas concentration reading.
Zero Buffering	Zero buffering is a function of the monitor which forces the gas concentration reading to zero when sensor is exposed to low concentration of a gas. The zero buffer is indicated in the sensor specification.
Zero Gas	Zero gas is gas in which the target gas is not present. The presence of oxygen is required. Clean air is an excellent source for zero calibration. A known gas concentration can be entered during zero calibration.



2 Product Specifications

2.1 AMC-1BZ Monitor

System	
System Warranty Period	2 Years
Power Supply Requirement	120 VAC, 60 Hz, 53 VA or 24 VDC, 2A
Relays – AMC-1BZ1 AMC-1BZ2	2x DPDT, 250 VAC, 10 A 4x DPDT, 250 VAC, 10 A
Operating Temperature	-4 to 104F (-20 to 40C)
Operating Pressure	0.9 to 1.1 atm
Humidity Range	15 to 90% RH, non-condensing
Terminal Block Torque	7 inch-pounds (0.8 N-m)
Analog Out	
Topology	Sourcing
Voltage Range	0-10 V
Current Range	0-20 mA
Corner Frequency	300 KHz
Analog In	
Voltage Range	0-3 V (Configured for Multidrop)
Real Time Clock (RTC)	
Battery Size	CR1025, Field Replaceable.
Expected Battery Life	> 2 Years

2.2 Product Description



The AMC-1BZ Gas Monitors are designed to work with any combination of AMC-122X Series sensor modules, with up to 10 modules per zone.

The Monitor provides a digital representation of the gas concentration; this information is displayed locally via OLED. Plug-and-play modular architecture accommodates; hot-pluggable Power/Comms via the BusPower Module and field replaceable Sensor Modules (eligible for the EZ Cal exchange program).

In addition, each Monitor features alarm / system status indicators, audible feedback, 2 relays, 2 analog outputs and colour-coded connection terminal blocks, as listed and described herein.

NOTE: The AMC-1B is a variant of our UTx platform. As such many of the menu items directly reference the parent product.

2.3 External View

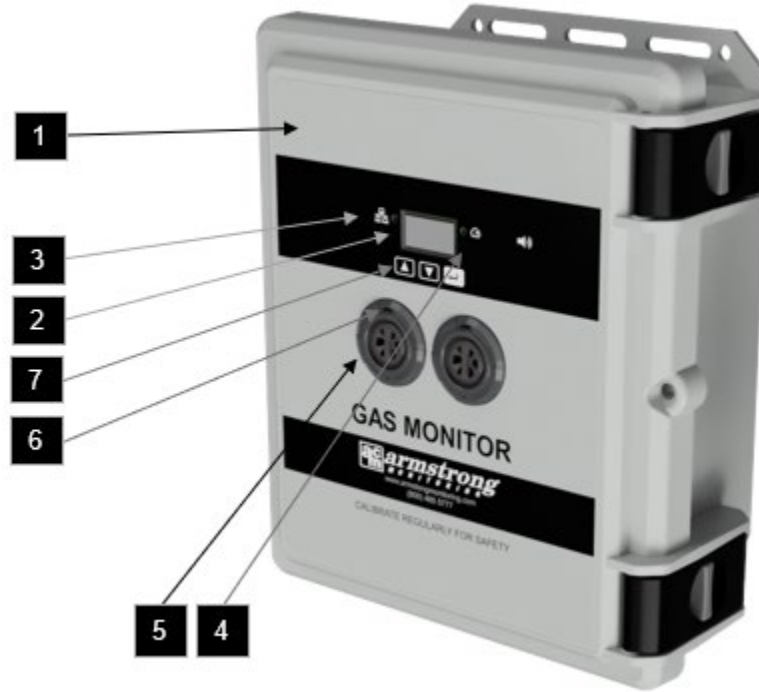

Figure 2-1: External View

1	Enclosure	Enclosure and Lid Assembly, UV Stabilized Polycarbonate, 11.750" L x 9.980" W x 5.460" H (300 x 250 x 140mm)
2	Digital Display	Display Gas Concentration & Status Information
3	Network Status LED	Not applicable to 1BZ Series
4	Alarm Status LED	The Sensor Status LED will show the same error code that is being communicated by the Sensor Module(s) or display the highest priority error (if multiple errors codes are being communicated to it by the Sensor Module(s))
5	Sensor Module Opening	Not applicable to 1BZ series
6	Sensor Module LED	Not applicable to 1BZ series
7	Menu Buttons	Momentary Pushbuttons for user interface.

2.4 Internal View

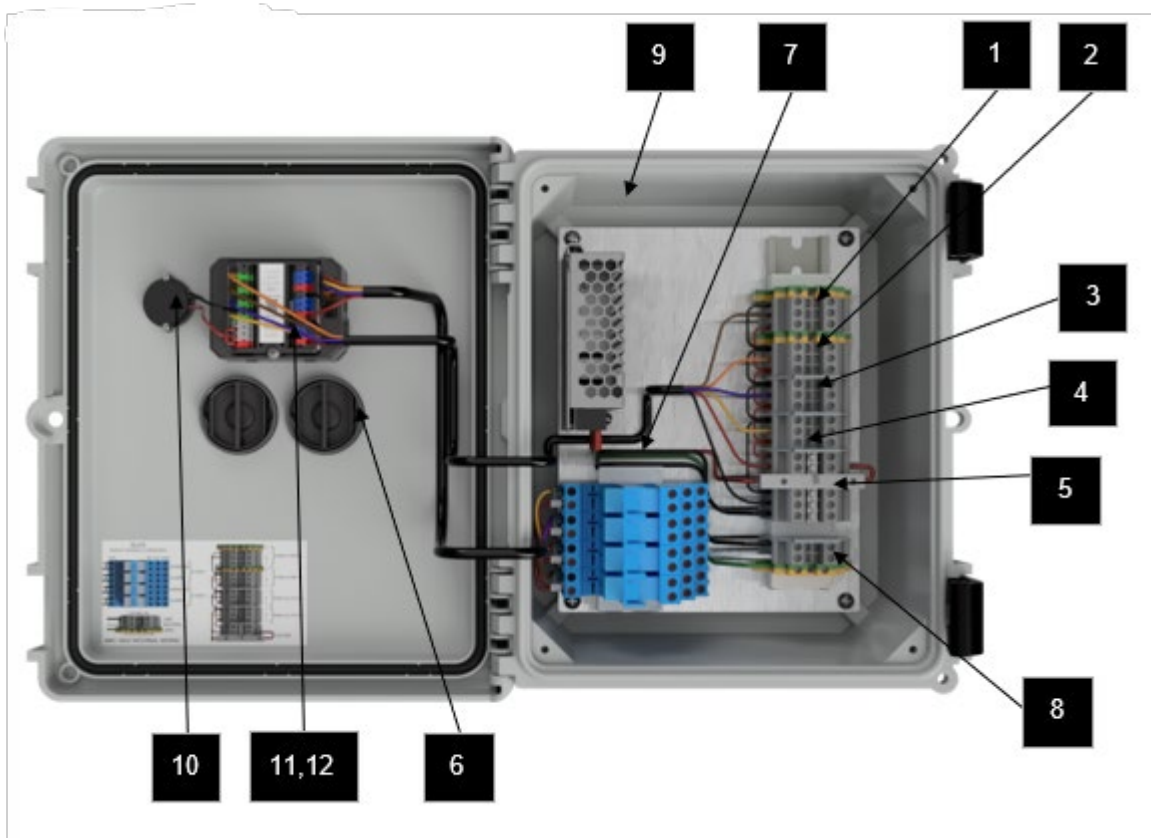

Figure 2-2: Internal View

1	Analog Input 1	Terminal Block for Zone 1 Input
2	Analog Input 2	Terminal Block for Zone 2 Input (AMC-1BZ2 Only)
3	Analog Output 1	Terminal Block for Signal Output 1
4	Analog Output 2	Terminal Block for Signal Output 2
5	2A Fuse	Device Level Input Protection
6	Sensor Module	Not applicable to 1BZ series
7	External Relays	Connection for Alarm/Warning System
8	Voltage IN	Terminal Block for Main Power In
9	Power Supply	Regulates power for the device. Present for 110 VAC input only.
10	Buzzer	Provides audible indication upon alarm state.
11	UTx Main Module	Information processing and communications hub.
12	Bus Power Module	Provides power and communications interface to the UTx.



3 Installation

3.1 Overview

The installation of the AMC-1B Gas Monitor is very important as the operational quality is a direct result of the quality of the installation. The following sections provide guidelines for installation; location and mounting, wiring, and cable selection.

3.2 Monitor Mounting

Care should be taken to securely fasten the monitor unit on a solid, non-vibrating surface or structure so that the sensors are located at approximately 4ft to 6ft (1.2m to 1.8m) above floor level or per local regulations. Install the unit in an area where the local concentration of gas is unaffected by the presence of ventilation systems and away from sources of interference gases. Mount the monitor where the unit can be observed periodically. See the below **Enclosure Mounting** figure for mounting hole locations.

CAUTION: All cable entry MUST BE through the BOTTOM of the monitor enclosure only. Other entry locations will allow foreign materials to enter the enclosure, causing possible damage to the internal components.

Warning:

Conduit entry from the top or back of the housing is Not Recommended. Any water damage related to conduit entry from the top or back will not be covered under warranty.

Qualified personnel should perform the installation according to applicable electrical codes, regulations and safety standards. Ensure correct cabling practices are implemented.



AMC-1BZx Gas Monitor

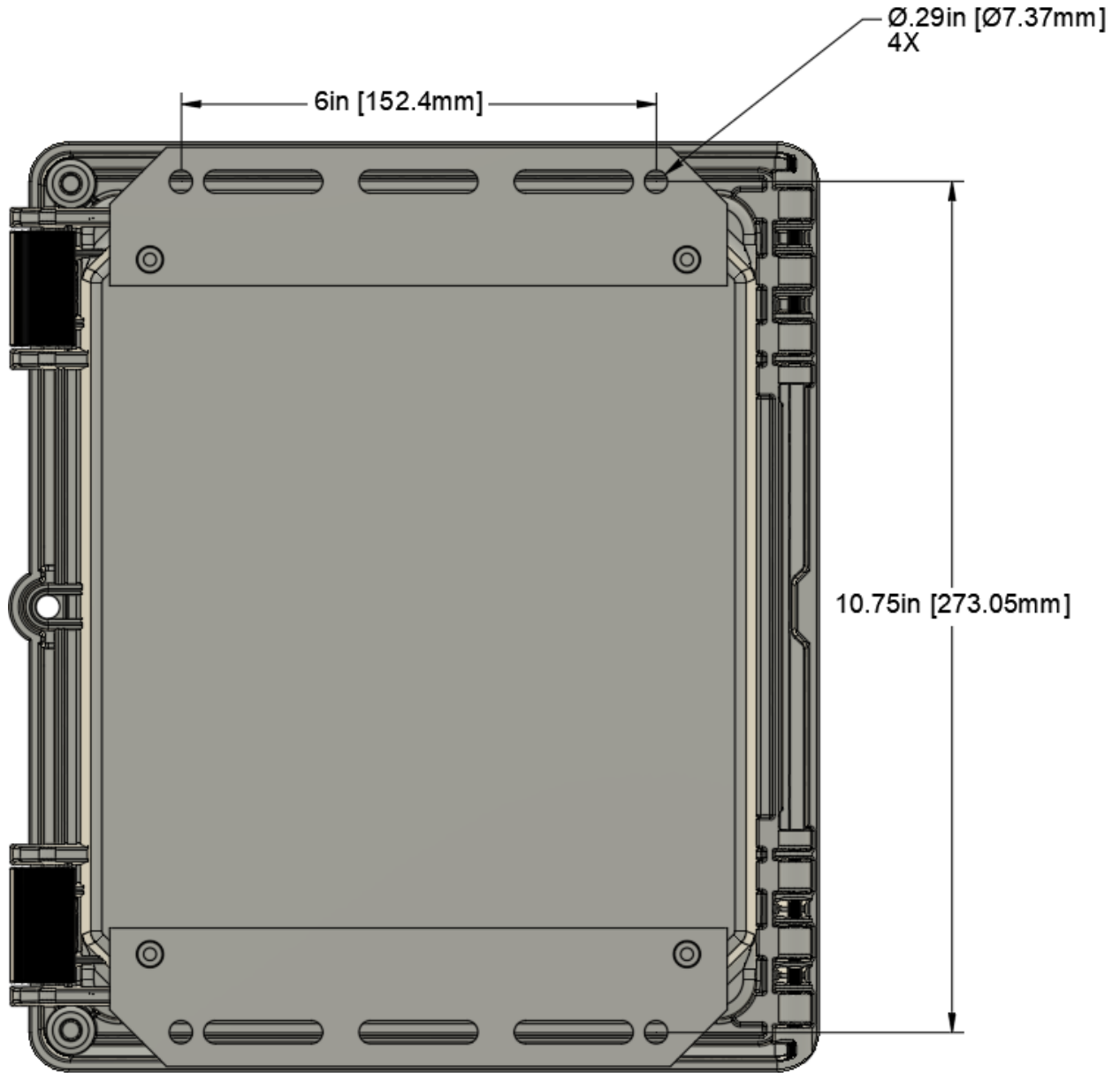

Figure 3-1: Enclosure Mounting

3.3 Wiring

3.3.1 Power Supply

The monitor operates on 120 VAC, 60 Hz or 24 VDC, 2A. The power supply connections are made at the power terminal block located inside the monitor.

All power and grounding connections to equipment must be made in accordance with applicable electrical and building codes.

For AC powered monitors, a separate, dedicated, noise free, 15 Amp power circuit, with an appropriately labeled circuit breaker is required.

3.3.2 Relays

The Monitor houses 2 relays. The relay contacts are rated for 10Amps @ 28VDC/120VAC resistive. For relay contact arrangement, see below. Note that default configuration is for the relays to be energized.

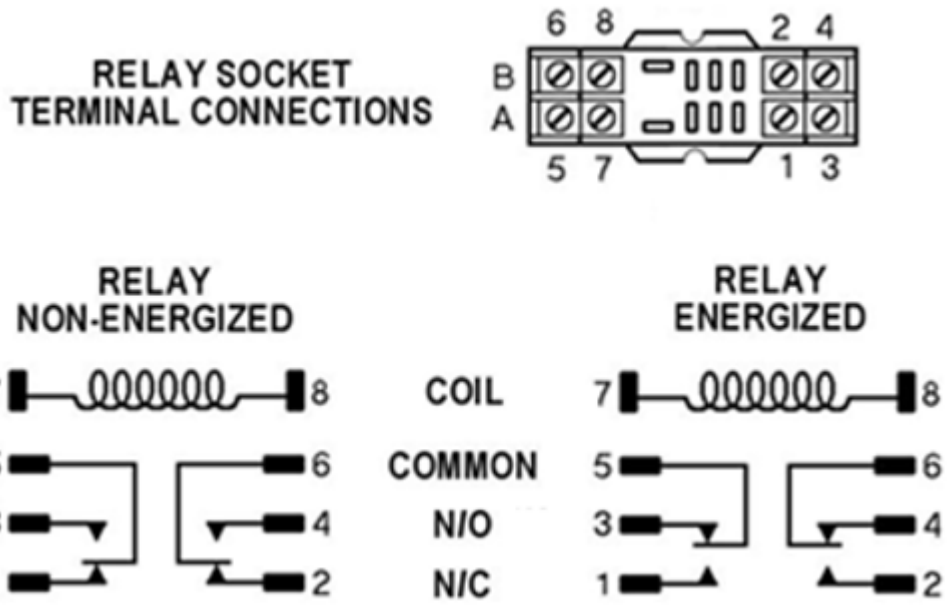

Figure 3-2: Relay Connections



3.3.3 Analog In (AMC-122x Sensor Modules)

The analog input terminal blocks (See the above **Internal View** figure) are used for connecting 122X Sensor Modules in Voltage Mode. The wiring for channel 1 and 2 is conveyed in the following table.

Gas Monitor	122x Sensor Module
Chassis Ground	Connect to the cable shield
Negative -	Negative -
Signal S	Signal S
Positive +	Positive +

For further detailed wiring instructions for multiple sensor modules on one channel (up to 10) see the corresponding sensor module manual.

3.3.4 Analog Out

Typically, analog output is used to communicate with a Building Automation System or control a Variable Frequency Drive within a ventilation system.

Each analog output accommodates either 4-20mA, 0-10V, 2-10V or AMC-Multidrop (proprietary).

Please contact Armstrong Monitoring directly for configurations to match your needs.



3.3.5 RAM-3

The AMC-RAM-3 provides a remote alarm indication when employed with monitors such as the AMC Gas Monitor 1BZ. Each RAM-3 has a red strobe light to provide a visual indicator of an alarm condition and remains active until the alarm is cleared. The Audio alert is provided by a buzzer which emits a 2900hz tone at in excess of 90 dB(A) at a distance of 24 inches. The audio alert is activated upon entry into an alarm condition and is silenced by either pushing the Acknowledge Switch or clearing the alarm.



To support connecting RAM-3 modules to the 1BZ Monitor the recommended method is ordering the AMC-RAM-1B-WH-2 (1BZ1) or AMC-RAM-1B-WH-4 (1BZ2) (Wiring Interface for RAM-3 and 1BZ Monitor). This item provides terminal block interfaces for wiring the RAM-3 to the 1BZ Monitor and to the High Alarm Relay output that drives activation of the RAM-3. The other option is to wire the RAM-3 directly to the relay contacts but that is not recommended. Further details are available in the AMC-RAM-3 User Manual available on the AMC Website.



4 Operation

4.1 Overview

This section describes how the functionalities of the AMC-1BZ Gas Monitor are operated and performed. Please consult the operation and initial configuration chapters below before attempting to use or calibrate the Gas Monitor.

4.2 Status LEDs

Refer to the **External View** section for LED location and descriptions.

During operation the LEDs will display the following configurations:

4.2.1 Start Up

Table 4-1: Status LEDs (Start Up)

LED States	Network LED	Alarm Status LED	Display Screen Message
Initialization and discovery of Sensor Modules (after UTx is powered up).	OFF	Solid WHITE	AMC Splash Screen
Sensor Warm-up	Flashing GREEN (1 sec Cycle)	Solid WHITE	Main Info Screen (or blank) No Sensor Gas Readings Shown

4.2.2 Network Status

Table 4-2: Status LEDs (Network Status)

LED States	Network LED	Alarm Status LED	Display Screen Message
Network status does not apply to 1B standalone monitors.	Flashing GREEN (1 sec Cycle)		



4.2.3 Faults

Table 4-3: Status LEDs (Faults)

LED States	Network LED	Alarm Status LED	Display Screen Message
Fault 1:			
Analog Input Below Fault Value	Flashing GREEN (1 sec cycle)	Solid RED	Gas Bar Indicates “FAULT” For Affected Sensors

4.2.4 Alarms

Table 4-4: Status LEDs (Alarms)

LED States	Network LED	Alarm Status LED	Display Screen Message
Threshold 1 Reached	Flashing GREEN (1 sec Cycle)	Solid YELLOW	Gas Bar Indicates “WARN” For Affected Sensors
Threshold 2 Reached	Flashing GREEN (1 sec Cycle)	Solid RED	Gas Bar Indicates “ALARM” For Affected Sensors
Threshold 3 Reached	Flashing GREEN (1 sec Cycle)	Solid RED	Gas Bar Indicates “ALARM” For Affected Sensors

4.2.5 Calibration

Table 4-5: Status LEDs (Calibration)

LED States	Network LED	Alarm Status LED	Display Screen Message
Cal Needed	Flashing GREEN (1 sec cycle)	Solid GREEN	Not Indicated on Display Screen
In Calibration Mode / Calibration Activity Waiting to Start	Flashing GREEN (1 sec cycle)	Solid GREEN	Calibration Routine Prompts
Calibration Looking for Stable	Flashing GREEN (1 sec cycle)	Solid GREEN	Calibration Routine Prompts
Calibration Pass	Flashing GREEN (1 sec cycle)	Solid GREEN	Calibration Routine Prompts
Calibration Fail	Flashing GREEN (1 sec cycle)	Solid GREEN	Calibration Routine Prompts

4.2.6 Miscellaneous

Table 4-6: Status LEDs (Miscellaneous)

LED States	Network LED	Alarm Status LED	Display Screen Message
Low RTC Battery	Flashing GREEN (1 sec cycle)		Not Indicated on Display Screen
Real-Time Clock (RTC) Disabled or Uninitialized	Flashing GREEN (1 sec cycle)	Solid MAGENTA	Not Indicated on Display Screen

4.3 Menu Overview

Note that a **Menu Flow Chart** is available further in this manual. The menu images and menu flow diagrams in this manual represent gas types with labels such as “GAS1”, “GAS2”, etc. These are mapped to specific gases based on the customer order.

4.3.1 Normal Operation

Upon startup, a brief splash screen is shown on the display which includes the Armstrong Monitoring Corp’s logo and the current version of the UTx firmware. After a couple of seconds, the display will update to show the main info screen (see below). NOTE: The bar graphs indicating gas concentration are not visible initially while the sensor modules are warming up. The warm-up period will be shown in the details section for the selected sensor until the warm-up period expires. NOTE: Factory configurations define a warm-up default value that prevents false alarms while sensors are warming up. This value may be viewed during warm-up through the detailed sensor screen section.

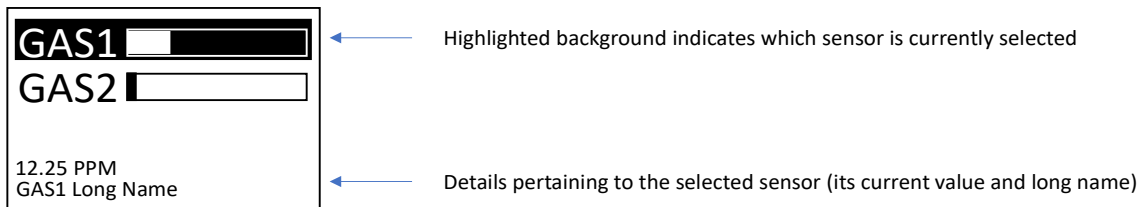

As shown above, two sensors are currently attached to the transmitter. Only one sensor can be selected at a time for the purpose of inspecting its details. Use the **UP** and **DOWN** buttons to navigate between each sensor. The following diagram illustrates the main info screen after pressing the **DOWN** button from the previous display. Notice how the details are updated to reflect the newly selected sensor.

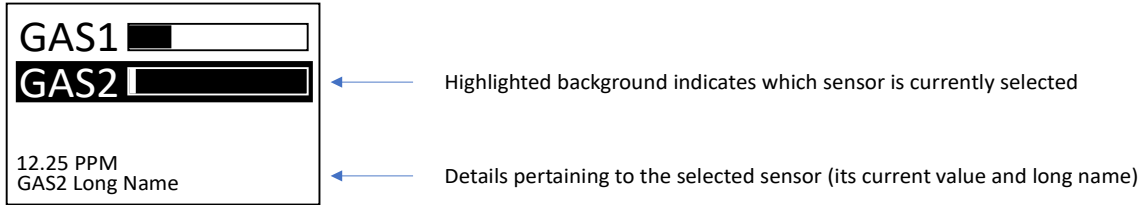

After a programmed timeout period without any button presses, the display will go blank (screen saver mode). To re-enable the display, simply press the **ENTER** button.

4.3.2 Failed Sensor

In the event of a failed sensor, the bar graph is replaced with a large FAIL indication and the detailed description is updated accordingly. If the sensor fails while the display is OFF, the display will immediately turn ON and the failed sensor will be selected by default. In addition, the FAIL indication will toggle between normal and inverse 'white space' mode at a rate of once per second as shown below.

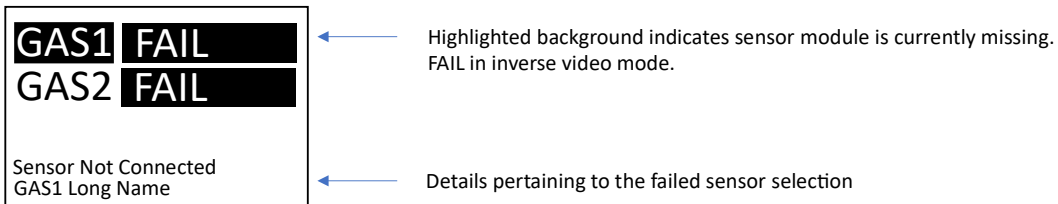
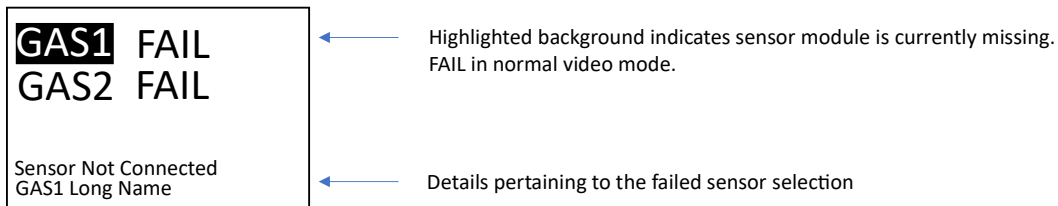

If the failure condition is resolved, the main display for the failed sensor will resume normal operation by indicating the sensor reading via bar graph.

4.3.3 Warning/Alarm Indication

When a warning or an alarm occurs, the bar graph is replaced with a large WARN indication for warnings or a large ALARM for alarms. If the sensor enters a warning or alarm state while the display is OFF, the display will immediately turn ON and the sensor responsible for the warning/alarm will be selected by default. Like the FAIL indication, the WARN/ALARM indication will toggle between normal and inverse 'white space' mode at a rate of once per second as shown below.



AMC-1BZx Gas Monitor

The user has the option to silence the buzzer while the warning/alarm condition is still active. To silence the alarm, the channel responsible for the warning/alarm needs to be selected and the user needs to press the **ENTER** button. Once silenced, the contextual help (small text) will provide an indication of how long the audio buzzer will remain silenced. Once this period expires, the previous ‘Press ENTER to ACK’ message will return, and the buzzer will resume operation.

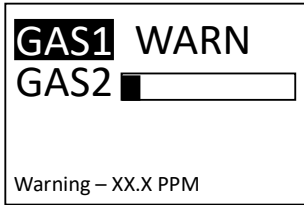

Highlighted background indicates which sensor is currently in a warning state. WARN in normal video mode.

Details pertaining to the sensor

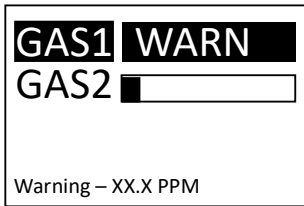

Highlighted background indicates which sensor is currently in a warning state. WARN in inverse video mode.

Details pertaining to the sensor

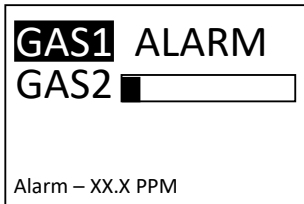

Highlighted background indicates which sensor is currently in alarm. ALARM in normal video mode.

Details pertaining to the selected sensor which is currently in alarm. The current sensor reading is shown.

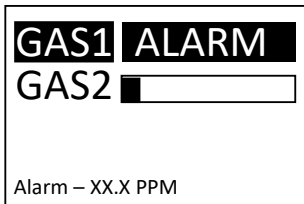

Highlighted background indicates which sensor is currently in alarm. ALARM in inverse video mode.

Details pertaining to the selected sensor which is currently in alarm. The current sensor reading is shown.

For units configured at factory to use latched alarms, when the alarm condition is cleared the display will indicate that the relays are latched until cleared by the user by pressing the **ENTER** button to release the latching condition.

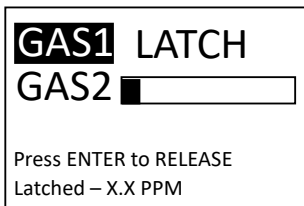

Highlighted background indicates which sensor is currently selected with latched relays. LATCH in normal video mode.

Details pertaining to the selected sensor which currently has its relays in Latched mode. The current sensor reading is shown with an instruction to press the **ENTER** button to release the relays from their active state.



Highlighted background indicates which sensor is currently selected with latched relays. LATCH in inverse video mode.

Details pertaining to the selected sensor which currently has its relays in Latched mode. The current sensor reading is shown with an instruction to press the **ENTER** button to release the relays from their active state.

4.3.4 Fault Indication

The following two menu images show a fault condition in normal and inverse video modes.

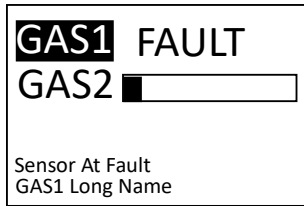

Highlighted background indicates which sensor is currently at fault. FAULT in normal video mode.

Details pertaining to the sensor at fault

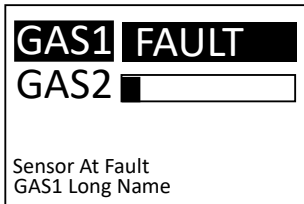

Highlighted background indicates which sensor is currently at fault. FAULT in inverse video mode.

Details pertaining to the sensor at fault

4.3.5 Detailed Sensor Screen

To access the detailed information for each sensor, press and hold the **UP** button until the following screen appears.

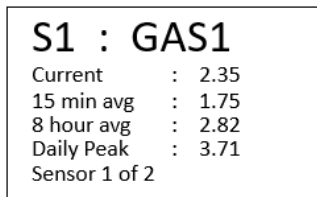

Label indicates which sensor is currently selected

Current instantaneous value for the selected sensor

15 min average value for the selected sensor

8 hour average value for the selected sensor

Daily peak value for the selected sensor

Paging info updated as different sensors are selected using **UP/DOWN** buttons

The detailed sensor screen provides several values for each sensor. Use the **UP** and **DOWN** buttons to page through all the attached sensors. This detailed screen will timeout after 300 seconds if no button is pressed thereby returning the user back to the main info screen. Alternatively, the user can exit the detailed sensor screen on demand by pressing the **ENTER** button to return back to the main info screen.



4.3.6 Detailed Status Screen

To access the detailed status for each sensor, press and hold the DOWN button until the following screen appears.

S1 : GAS1	←	Label indicates which sensor is currently selected
Status : Normal	←	Current operational status for the selected sensor
Last Cal : 76 days	←	Number of days since last calibration for the selected sensor
Next Cal : 104 days	←	Number of days until next calibration for the selected sensor
Lifetime : 2126 days	←	Remaining sensor life for the selected sensor
S/N : 1234	←	Serial number for the selected sensor
Sensor 1 of 2	←	Paging info updated as different sensors are selected using UP/DOWN buttons

The detailed status screen provides the complete status for each sensor. Use the UP and DOWN buttons to page through all the attached sensors. This detailed screen will timeout after 300 seconds if no button is pressed thereby returning the user back to the main info screen. Alternatively, the user can exit the detailed status screen on demand by pressing the ENTER button to return to the main info screen.

NOTE: All information dependent on the real-time clock (RTC) such as 'Last Cal' or 'Next Cal' may be incorrect if the RTC is currently disabled or uninitialized (as indicated by a solid magenta on the Alarm Status LED).

Continuing to press **DOWN** after the sensor pages show the firmware version of up to all four modules that are available on the UTx platform. This list also displays the date and time for convenience.

FIRMWARE	←	'Firmware' serves as a label only
TM : v5.14	←	Transmitter (UTx) firmware version
DM : v5.14	←	Display module firmware version
SM1 : v5.14	←	First sensor module version, if applicable
SM2 : v5.13	←	Second sensor module version, if applicable
YYYY-MM-DD HH:MM:SS	←	Date and time information

4.3.7 Quick Info Screen

To access the quick info screen, simultaneously press the UP and DOWN buttons from the main screen, until the following screen appears.

The quick info screen provides the bus voltage supplied to unit (V), RTC battery voltage (V), temperature (°C and °F), pressure (Pa), and relative humidity (%RH), or "N/A" if not available.

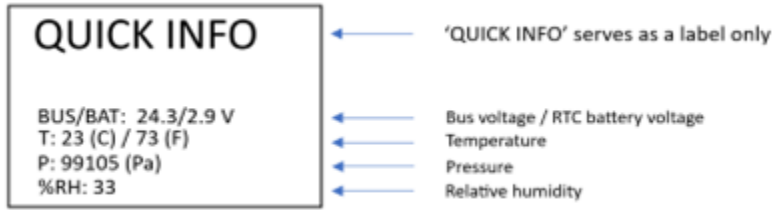

The user can exit the quick info screen by pressing the ENTER button to return to the main info screen.

4.3.8 Password Entry

To access the service menu system, the user needs to press and hold the **ENTER** button until the following password entry screen is displayed.

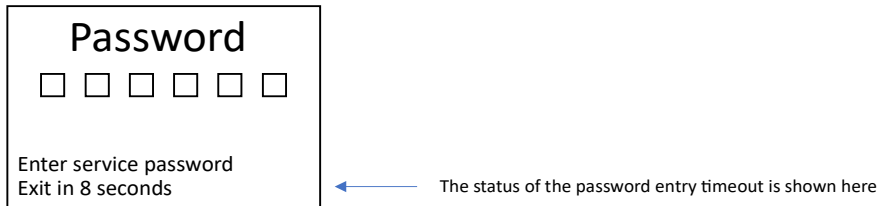

Enter the password using a combination of the **UP**, **DOWN** and **ENTER** buttons. The password is factory set to **UP - DOWN - UP - DOWN - ENTER - ENTER**. As the password is being entered, the display updates with each button press. The diagram below illustrates the state of the password entry after 3 button presses. The password entry screen will timeout after 10 seconds if no button is pressed thereby returning the user back to the main info screen.

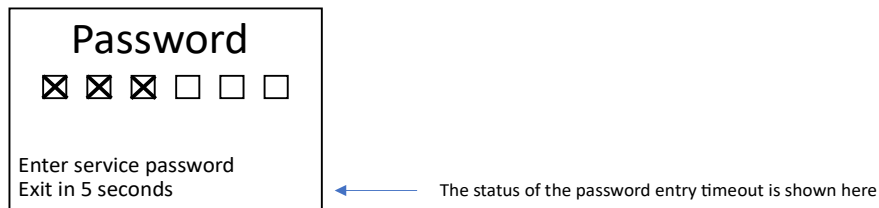

4.3.9 Main Service Menu

4.3.9.1 Service Menu Timeout

The service menus remain unlocked for a programmed timeout period (set to 5 minutes). Within that period, the service menus can be re-enabled by long pressing the **ENTER** button. If the timeout period is allowed to expire, the password entry screen will appear prior to accessing the service menus. Also, if the service menu is active when a timeout occurs, the service mode is disabled, and the display will go blank (i.e. power saving mode). Lastly, the service menu timeout is reset with each button press while the service menus are active.



4.3.9.2 Service Menu Overview

Once the correct password is entered, the main service menu is displayed as shown in the following diagram.

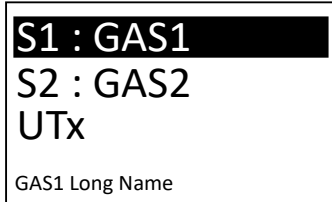

← Highlighted background indicates which service menu is selected

← The name of the selected service menu. In the case of a sensor service menu, the sensor’s gas serves as its name

Once again, the **UP** and **DOWN** buttons can be used to navigate the list of service menus. The main service menu provides the menu items listed in the table below:

Table 4-7: Service Menu Options

Menu Item	Description
<Sensor #>: <Gas Label>	Each sensor is included in the service menu indicated by its number and gas label (Ex: S2: CO).
UTx	Access the settings for the transmitter module through the ‘UTx’ menu item.
Exit	Select this menu item to exit the service menu.

To exit the Service Menu, press **DOWN** repeatedly until the end is reached and Exit is highlighted as shown below.

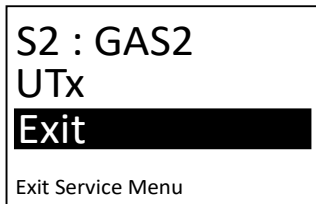

← Highlighted background indicates that Exit is selected

← Context sensitive help

With ‘Exit’ highlighted (as above), press **ENTER** to exit the service mode and return back to the main info screen as shown below.

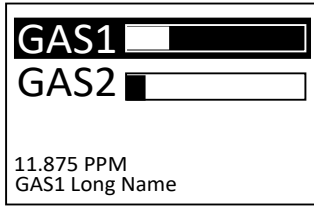

← Upon exiting the service menus, the first sensor is selected by default

← Details for the current sensor are updated in real-time as well as the progress bar which represents the current value relative to its max value

4.3.10 External Sensor Service Menu

NOTE: The Outputs menu (available from the main service menu) is used to provide supplemental configuration options that are applicable to external sensors, beyond those in the External Sensor Service menu.

4.3.10.1 External Sensor Service Menu Overview

If the **ENTER** button is pressed while the service menus are active and an external sensor is currently selected, then the following menu is shown for external sensors. This menu is common to all external sensors, therefore, selecting any external sensor will produce the same menu.

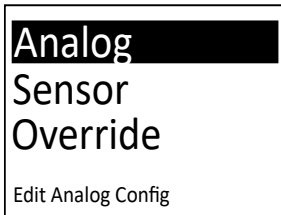

← Context sensitive help (for the currently highlighted menu item)

The **UP** and **DOWN** buttons can be used to navigate the list of service menus for the selected sensor. The sensor's service menu provides the following menu items:

Table 4-8: External Sensor Menu Options

Menu Item	Description
Analog	Analog configuration sub-menu for the selected sensor.
Sensor	Sensor configuration sub-menu for the selected sensor.
Override	Override sub-menu for the selected sensor.
Exit	Select this menu to return to the main service menu.

4.3.10.2 Analog Sub-Menu

If 'Analog' configuration sub-menu is activated from the sensor's service menu when an external sensor is selected, then the display will be updated to show the following sub-menu.

- ← Activate this menu item to edit the fault threshold for voltage mode input
- ← Activate this menu item to edit the fault threshold for current mode input
- ← Highlighted background indicates that Exit is selected
- ← Context sensitive help (for the currently highlighted menu item)

The **UP** and **DOWN** buttons can be used to navigate the list of analog configuration options for the selected external sensor. The analog configuration sub-menu is defined in the below table:

Table 4-9: Analog Sub-Menu Options

Menu Item	Description
Fault (V)	Activate this menu item to edit the fault threshold (in V) for voltage mode input.
Fault (mA)	Activate this menu item to edit the fault threshold (in mA) for current mode input.
Exit	Select this menu item to return to the sensor’s service menu. The ‘Analog’ sub-menu will be selected when the sensor’s service menu appears.

If ‘Fault (V)’ is activated from the ‘Analog’ configuration sub-menu, then the display will be updated to show the following editing screen.

- ← ‘Fault (V)’ serves as a label only.
- ← Edit the voltage fault threshold value one digit at a time using the **UP/DOWN** buttons. Press **ENTER** to advance the cursor to the next digit. Press **ENTER** when the last digit is highlighted to save the value.
- ← Context sensitive help (for the currently highlighted menu item)

When the **ENTER** button is pressed with the last digit selected, the screen will update to display the confirmation dialog (described previously). If ‘Yes’ is selected, the edit value is persisted as the new value for the voltage fault threshold for the selected external sensor. Otherwise, the edit value is rejected. In either case, the menu returns to the ‘Analog’ configuration sub-menu menu with the ‘Fault (V)’ menu item selected.

NOTE: This value only applies when the input mode is voltage mode and has a non-zero minimum input. For example, with an external sensor configured for operation between 2 - 10 V, setting a fault value of 1 V would lead to the sensor being found in a ‘FAIL’ state with an input voltage of less than 1 V.

CAUTION: Entering a fault value of 0 V disables the fault check.



If 'Fault (mA)' is activated from the 'Analog' configuration sub-menu, then the display will be updated to show the following editing screen.

← 'Fault (mA)' serves as a label only.

← Edit the current fault threshold value one digit at a time using the UP/DOWN buttons. Press ENTER to advance the cursor to the next digit. Press ENTER when the last digit is highlighted to save the value.

← Context sensitive help (for the currently highlighted menu item)

When the **ENTER** button is pressed with the last digit selected, the screen will update to display the confirmation dialog (described previously). If Yes is selected, the edit value is persisted as the new value for the current fault threshold for the selected external sensor. Otherwise, the edit value is rejected. In either case, the menu returns to the 'Analog' configuration sub-menu menu with the 'Fault (mA)' menu item selected.

NOTE: This value only applies when the input mode is current mode and has a non-zero minimum input. For example, with an external sensor configured for operation between 4 - 20 mA, setting a fault value of 2 mA would lead to the sensor being found in a 'FAIL' state with an input current of less than 2 mA.

CAUTION: Entering a fault value of 0 mA disables the fault check.

If 'Exit' is activated from the 'Analog' configuration sub-menu, then the user is returned to the sensor's service menu for an external sensor.

4.3.10.3 Sensor Sub-Menu

If the 'Sensor' sub-menu is activated from the sensor's service menu when an external sensor is selected, then the display will be updated to show the following sub-menu.

← Activate this menu item to edit the gas label for the selected sensor

← Activate this menu item to edit the engineering units for the selected sensor

← Activate this menu item to exit the external sensor service sub-menu

← Context sensitive help (for the currently highlighted menu item)

The **UP** and **DOWN** buttons can be used to navigate the list of sensor configuration options for the selected external sensor. The sensor configuration sub-menu is defined in the below table:

Table 4-10: Sensor Sub-Menu Options

Menu Item	Description
Gas Label	Activate this menu item to edit the gas label for the selected sensor.
Eng Units	Activate this menu item to edit the engineering units for the selected sensor.



AMC-1BZx Gas Monitor

Exit	Select this menu item to return to the sensor’s service menu. The ‘Config’ sub-menu will be selected when the sensor’s service menu appears.
------	--

4.3.10.4 Gas Label

If ‘Gas Label’ is activated from the ‘Sensor’ sub-menu, then the display will be updated to show the following editing screen.

- ← ‘Gas Label’ serves as a label only, therefore, this item can not be selected.
- ← Edit the gas label value character at a time using the UP/DOWN buttons. Press ENTER to advance the cursor to the next character. Press ENTER when the last character (space) is highlighted to save the value.
- ← Context sensitive help (for the currently highlighted menu item)

Each character can be edited to any alpha-numeric value (A-Z, 0-9) including a space. When **ENTER** button is pressed with the last non-space character highlighted, a space will be appended to the label to allow expanding the label value.

When the **ENTER** button is pressed with the last character selected and that character is a space, the screen will update to display the confirmation dialog (described previously). If ‘Yes’ is selected, the edit value is persisted as the new value for the Gas Label for the selected external sensor. Otherwise, the edit value is rejected. In either case, the menu returns to the ‘Sensor’ configuration sub-menu menu with the ‘Gas Label’ menu item selected.

4.3.10.5 Engineering Units

If ‘ENG UNITS’ is activated from the ‘Sensor’ sub-menu, then the display will be updated to show the following editing screen.

- ← ‘Eng Units’ serves as a label only.
- ← The engineering units can be selected from a list of options using the UP/DOWN Buttons to cycle between each option. Press ENTER to save the selected options.
- ← Context sensitive help (for the currently highlighted menu item)

The available options for ‘ENG UNITS’ are listed in the following table.

Table 4-11: Engineering Unit Options

Menu Item	Description
PPB	Parts per Billion
PPM	Parts per Million
% LEL	Percent of Lower Explosive Limit
% VOL	Percent by Volume



AMC-1BZx Gas Monitor

Volt	Voltage
% FS	Percent of Full Scale
% LFL	Percent of Lower Flammable Limit

When the **ENTER** button is pressed, the screen will update to display the confirmation dialog (described previously).

When the **ENTER** button is pressed, the screen will update to display the confirmation dialog (described previously).

4.3.10.6 Simulation Of Gas Levels (External Sensors)

The External Sensor Menu allows the current gas reading of an external sensor to be overridden by a simulated gas level. This may be useful during the system commissioning to verify operation of the Monitor or alarm relays.

Table 4-12: External Override Sub-Menu Options

Menu Item	Description
Sim Enable	Menu item for turning the external gas override value on/off.
Sim Gas	Allows an external override value to be selected (only applied if Sim Enable set to “Enabled”).
Exit	Select this menu item to return to the external sensor service menu.

4.3.10.7 Override

If ‘Override’ sub-menu is activated from the external sensor’s service menu, then the display will be updated to show the following sub-menu.

← Sim Enable: Activate this menu item to edit the simulated gas enable flag for the selected sensor

← Sim Gas: Activate this menu item to edit the simulated gas concentration for the selected sensor

← Exit: Activate this menu item to exit the “Override” sub-menu

← Edit Sim Enable: Context sensitive help (for the currently highlighted menu item)

4.3.10.8 Sim Enable

If ‘Sim Enable’ is activated from the ‘Override’ sub-menu, then the display will be updated to show the following editing screen.

← Disabled: Defaults to the current value of the Sim Enable flag. Use UP/DOWN arrow buttons to toggle between Disabled and Enabled. Press ENTER button to confirm selection.

← Press Enter to Save: Context sensitive help (for the currently highlighted menu item)



When the **ENTER** button is pressed, the confirmation screen (described previously) is displayed. If 'Yes' is selected, the edit value is persisted as the new value for the Sim Enable flag. Otherwise, the edit value is rejected. In either case, the menu returns to the Override sub-menu menu with the 'Sim Enable' menu item selected.

4.3.10.9 Sim Gas

If 'Sim Gas' is activated from the 'Override' sub-menu, then the display will be updated to show the following editing screen.

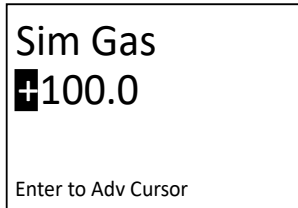

- ← 'Sim Gas' serves as a label only.
- ← Edit the simulated gas value one digit at a time using the UP/DOWN buttons. Press **ENTER** to advance the cursor to the next digit. Press **ENTER** when the last digit is highlighted to save the value.
- ← Context sensitive help

When the **ENTER** button is pressed with the last digit highlighted, the confirmation screen (described previously) is displayed. If 'Yes' is selected, the edit value is persisted as the new value for the Sim Gas concentration value. Otherwise, the edit value is rejected. In either case, the menu returns to the Override sub-menu menu with the 'Sim Gas' menu item selected.

Selected 'Exit' from the 'Override' sub-menu returns the user to the sensor's service menu with the 'Override' menu item selected.

4.3.11 Transmitter Service Menu

If the 'UTx menu item is activated from the main service menu via the **ENTER** button, then UTx service menu will appear on the display as shown in the following diagram.

The **UP** and **DOWN** buttons can be used to navigate the list of service menus for the UTx. The following table outlines all the menu items from the UTx menu:

Table 4-13: Transmitter Service Menu

Menu Item	Description
Sensors	Select this menu item to activate the Sensors sub-menu.
Alarms	Select this menu item to activate the Alarms sub-menu.
Relays	Select this menu item to activate the Relays sub-menu.
Test	Select this menu item to toggle the test enable flag.
Buzzer	Select this menu item to toggle the low alarm buzzer enable flag.
Ack Timer	Select this menu item to adjust the buzzer acknowledgement timeout (30 – 120 seconds).
Reset	Select this menu item to trigger a software reset of the UTx.
Exit	Select this menu item to return to the main service menu. The menu item for the UTx will be selected when the main service menu appears.

4.3.11.1 Transmitter Sensors Settings

From the UTx service menu, selecting 'Sensors' will update the display to show the following sub-menu.

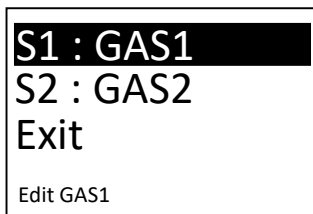

← Context sensitive help (for the currently highlighted menu item)

The **UP** and **DOWN** buttons can be used to navigate the list of configured sensors for the sensors sub-menu. The table below outlines all the menu items from the sensors sub-menu:

Table 4-14: Sensor Module Configuration Menu

Menu Item	Description
S1: GAS1	Select this menu item to activate the configuration sub-menu for sensor 1.
S2: GAS2	Select this menu item to activate the configuration sub-menu for sensor 2.
Exit	Select this menu item to return to the UTx service menu.

4.3.11.2 Sensor Alarm Configuration Sub-Menu

Selecting a sensor from the ‘Sensors’ sub-menu (ex: S1: GAS1) will update the display to show the following sub-menu.

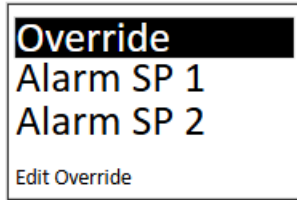

← Context sensitive help (for the currently highlighted menu item)

The **UP** and **DOWN** buttons can be used to navigate the list of menus for the ‘Sensors’ sub-menu. The below table outlines all the menu items from the sensor sub-menu:

Table 4-15: Sensor Alarm Configuration

Menu Item	Description
Override	Override sub-menu item for the selected sensor.
Alarm SP 1-3	Select this menu item to edit the alarm setpoints for the selected alarm (1-3).
Alarm Hyst	Select this menu item to edit the alarm hysteresis. This hysteresis value is applied to all alarm setpoints.
Zero Buff	Select this menu item to edit the zero-buffer level for the display of small gas concentrations.
Cal Freq	Select this menu item to edit the time period between re-calibrations.
Exit	Select this menu item to return to the Sensors sub-menu.

4.3.11.2.1 Override

The override menu item allows the current gas reading to be overridden by a simulated gas level. This may be useful during system configuration to verify operation of the Digital Monitor or alarm relays.

NOTE: An override menu item may be found in the Sensor Service menus. It’s usage is identical. Should the user activate the override through both menus at the same time, the override value entered through this Sensor Alarm Configuration sub-menu will take precedence.

If ‘Override’ is activated from the Sensor Alarm Configuration sub-menu, then the display will be updated to show the following sub-menu:

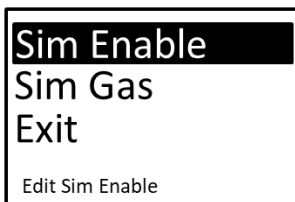

- ← Activate this menu item to edit the simulated gas enable flag for the selected sensor
- ← Activate this menu item to edit the simulated gas concentration for the selected sensor
- ← Activate this menu item to exit the ‘Override’ sub-menu
- ← Context sensitive help (for the currently highlighted menu item)



AMC-1BZx Gas Monitor

If 'Sim Enable' is activated from the 'Override' sub-menu, then the display will be updated to show the following editing screen.

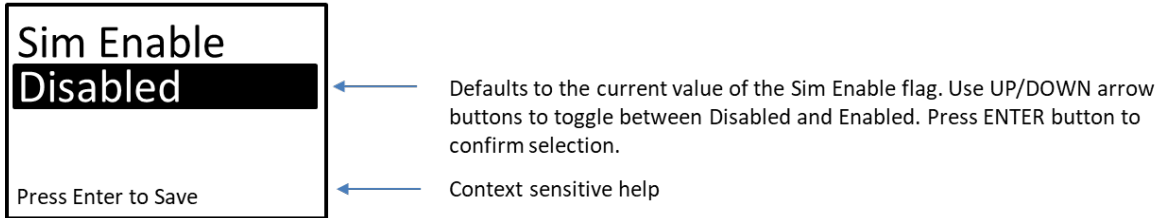

When the **ENTER** button is pressed, the confirmation screen (described previously) is displayed. If 'Yes' is selected, the edit value is persisted as the new value for the Sim Enable Flag. Otherwise, the edit value is rejected. In either case, the menu returns to the Override sub-menu menu with 'Sim Enable' menu is selected.

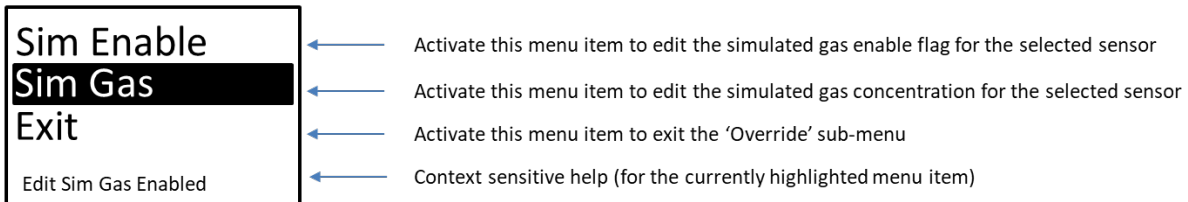

If 'Sim Gas' is activated from the 'Override' sub-menu, then the display will be updated to show the following editing screen.

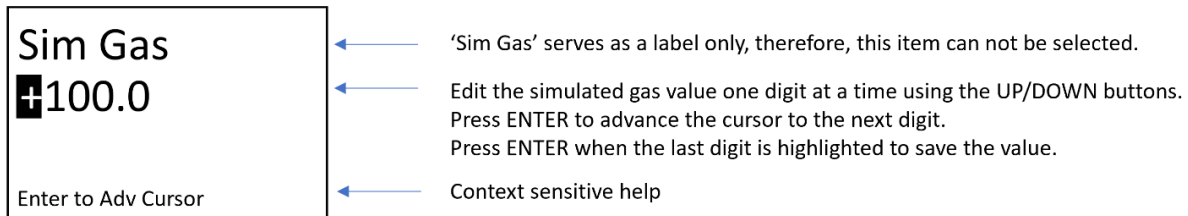

When the **ENTER** button is pressed with the last digit highlighted, the confirmation screen (described previously) is displayed. If 'Yes' is selected, the edit value is persisted as the new value for the Sim Gas concentration value. Otherwise, the edit value is rejected. In either case, the menu returns to the Override sub-menu menu with the 'Sim Gas' menu item selected.

Selected 'Exit' from the 'Override' sub-menu returns the user to the Sensor Alarm Configuration sub-menu with the 'Override' menu item selected.

4.3.11.2.2 Setpoint

If 'Alarm SP 1' is activated from the sensor alarm configuration sub-menu, then the display will be updated to show the following editing screen.

<p>Alarm SP 1 +025.0</p> <p>Enter To Adv Cursor</p>	<p>← 'Alarm SP 1' serves as a label only.</p> <p>← Edit the alarm 1 setpoint value one digit at a time using the UP/DOWN buttons. Press ENTER to advance the cursor to the next digit. Press ENTER when the last digit is highlighted to save the value.</p> <p>← Context sensitive help</p>
---	--

When the **ENTER** button is pressed, the screen will update to display the confirmation dialog (described previously).

The same process is repeated for Alarm SP 2 and Alarm SP 3. In all cases, once the confirmation dialog is reached, regardless of which option it selected, the user is returned back to the Sensors sub-menu.

4.3.11.2.3 Alarm Hysteresis

If 'Alarm Hyst' is activated from the sensor sub-menu, then the display will be updated to show the following editing screen.

<p>Alarm Hyst +02.0</p> <p>Enter To Adv Cursor</p>	<p>← 'Alarm Hyst' serves as a label only.</p> <p>← Edit the alarm hysteresis setpoint value one digit at a time using the UP/DOWN buttons. Press ENTER to advance the cursor to the next digit. Press ENTER when the last digit is highlighted to save the value.</p> <p>← Context sensitive help</p>
--	---

When the **ENTER** button is pressed, the screen will update to display the confirmation dialog (described previously). If 'Yes' is selected, the edit value is persisted as the new value for the Alarm Hysteresis for the selected sensor. Otherwise, the edit value is rejected. In either case, the menu returns to the Sensor sub-menu menu with the 'Alarm Hyst' menu item selected.

4.3.11.2.4 Zero Buffer

If 'Zero Buff' is activated from the sensor sub-menu, then the display will be updated to show the following editing screen.

<p>Zero Buff +000</p> <p>Enter To Adv Cursor</p>	<p>← 'Zero Buff' serves as a label only.</p> <p>← Edit the alarm hysteresis setpoint value one digit at a time using the UP/DOWN buttons. Press ENTER to advance the cursor to the next digit. Press ENTER when the last digit is highlighted to save the value.</p> <p>← Context sensitive help</p>
--	--

When the **ENTER** button is pressed, the screen will update to display the confirmation dialog (described previously). If 'Yes' is selected, the edit value is persisted as the new value for the Zero



Buffer for the selected sensor. Otherwise, the edit value is rejected. In either case, the menu returns to the Sensor sub-menu menu with the 'Zero Buff' menu item selected.

4.3.11.2.5 Calibration Frequency

If 'Cal Freq' is activated from the sensor sub-menu, then the display will be updated to show the following editing screen.

'Cal Freq' serves as a label only.

The calibration frequency can be selected from a list of options using the UP/DOWN buttons to cycle between each option. Press ENTER to save the selected options.

Context sensitive help

The available options for 'Cal Freq' are listed in the table below.

Table 4-16: Calibration Frequency Configuration

Menu Item	Description
OFF	Next calibration due date is not calculated.
3 Months	Next calibration due date is calculated as 3 months from last calibration timestamp.
4 Months	Next calibration due date is calculated as 4 months from last calibration timestamp.
6 Months	Next calibration due date is calculated as 6 months from last calibration timestamp.
12 Months	Next calibration due date is calculated as 12 months from last calibration timestamp.

When the ENTER button is pressed, the screen will update to display the confirmation dialog (described previously).

4.3.11.3 Transmitter Alarms Settings

From the UTx service menu, selecting 'Alarms' will update the display to show the following sub-menu.

Context sensitive help (for the currently highlighted menu item)



The **UP** and **DOWN** buttons can be used to navigate the list of menus for the Alarms sub-menu. The table below outlines all the menu items from the Alarms sub-menu:

Table 4-17: Transmitter Alarm Settings

Menu Item	Description
Alarm 1-18	Select this menu item to activate the configuration sub-menu for the selected alarm.
Exit	Select this menu item to return to the UTx service menu. The alarms menu item will be selected when the UTx service menu appears.

4.3.11.4 Alarm Sub-Menu

Selecting an alarm from the alarms sub-menu will update the display to show the following:

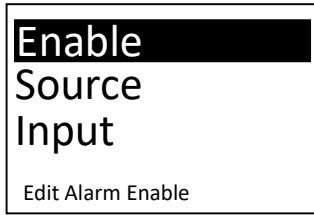

← Context sensitive help (for the currently highlighted menu item)

The below table outlines all the menu items from the alarm sub-menu:

Table 4-18: Transmitter Alarm Sub-Menu Settings

Menu Item	Description
Enable	Select this menu item to edit the alarm's enable state.
Source	Select this menu item to edit the alarm's source (i.e. from the available sensors).
Input	Select this menu item to edit the alarm's input value.
Level	Select this menu item to edit the alarm's setpoint.
Type	Select this menu item to edit the alarm's type (increasing or decreasing).
Output	Select this menu item to edit the alarm's trigger output (i.e. activate which relays).
Act Delay	Select this menu item to edit the alarm's act delay in terms of seconds.
Min Run	Select this menu item to edit the alarm's minimum run time in terms of seconds.
Exit	Select this menu item to return to the Alarms sub-menu.

4.3.11.4.1 Enable

If 'Enable' is activated from the alarm sub-menu, then the display will be updated to show the following editing screen.

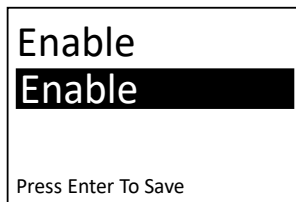

← 'Enable' serves as a label only.

← Defaults to the current value of the Enable flag. Use UP/DOWN arrow buttons to toggle between Disabled and Enabled. Press ENTER button to confirm selection.

← Context sensitive help

When the **ENTER** button is pressed, the confirmation screen (described previously) is displayed.

4.3.11.4.2 Source

If 'Source' is activated from the alarm sub-menu, then the display will be updated to show the following editing screen.

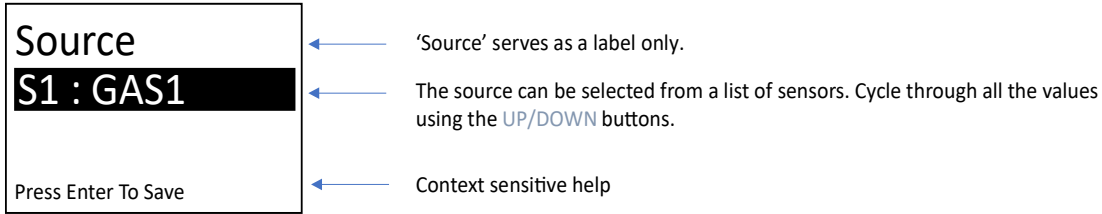

The available options for 'Source' are equal to the list of sensors currently configured for the UTx. The label for each sensor is dynamically assigned to S<n>: GAS<n> where n represents the sensor's 1 base index and GAS represents the sensor's gas name in short form.

When the **ENTER** button is pressed, the screen will update to display the confirmation dialog (described previously).

4.3.11.4.3 Input

If 'Input' is activated from the alarm sub-menu, then the display will be updated to show the following editing screen.

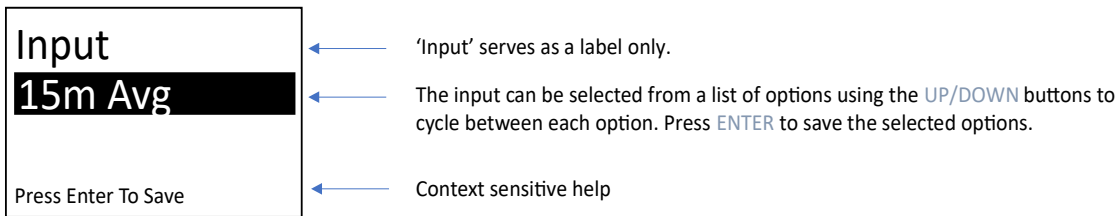

The available options for 'Input' are listed in the table below:

Table 4-19: Alarm Input Options

Menu Item	Description
Inst. Value	Instantaneous gas value, updated once per second.
15m Avg	Gas concentration averaged over the past 15 minutes.
8h Avg	Gas concentration averaged over the past 8 hours.
Daily Peak	Daily peak value.

When the **ENTER** button is pressed, the screen will update to display the confirmation dialog (described previously).

4.3.11.4.4 Level

If 'Level' is activated from the alarm sub-menu, then the display will be updated to show the following editing screen.

'Level' serves as a label only.

The level can be selected from a list of options using the UP/DOWN buttons to cycle between each option. Press ENTER to save the selected options.

Context sensitive help

The available options for 'Level' are listed the below table.

Table 4-20: Alarm Setpoint Options

Menu Item	Description
Warning	Alarm setpoint 1 from the selected source.
Alarm	Alarm setpoint 2 from the selected source.
High Alarm	Alarm setpoint 3 from the selected source.

When the **ENTER** button is pressed, the screen will update to display the confirmation dialog (described previously).

4.3.11.4.5 Type

If 'Type' is activated from the alarm sub-menu, then the display will be updated to show the following editing screen.

'Type' serves as a label only.

The type can be selected from a list of options using the UP/DOWN buttons to cycle between each option. Press ENTER to save the selected options.

Context sensitive help

The available options for 'Type' are listed in the table below:

Menu Item	Description
Increasing	Alarm is triggered when alarm exceeds its threshold in an increasing direction.
Decreasing	Alarm is triggered when alarm exceeds its threshold in a decreasing direction.

When the **ENTER** button is pressed, the screen will update to display the confirmation dialog (described previously).



4.3.11.4.6 Output

If 'Output' is activated from the alarm sub-menu, then the display will be updated to show the following editing screen.

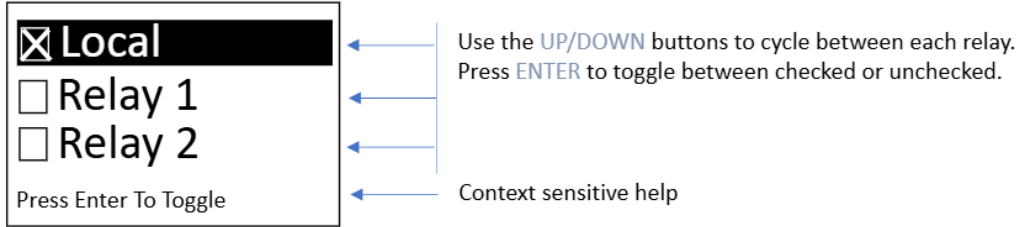

The available options for 'Output' are 'Local' and 'Relay 1' through 'Relay 5' (depending on variant). If the checkbox next to the relay is checked, then that relay will activate when the associated alarm is active. Otherwise, the relay will not activate.

When the **ENTER** button is pressed with 'Done' selected, the screen will update to Transmitter Alarm Sub-Menu.

4.3.11.4.7 Act Delay

If 'Act Delay' is activated from the Alarm sub-menu, then the display will be updated to show the following editing screen.

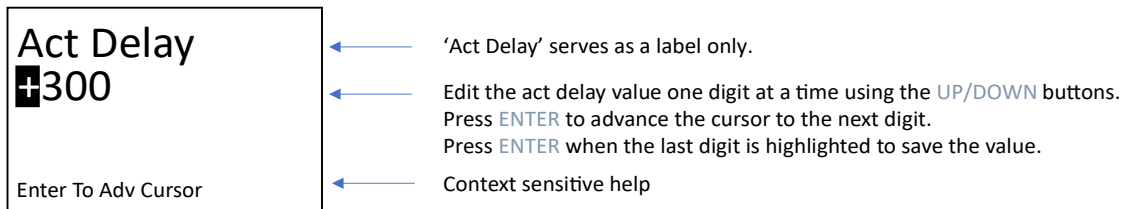

When the **ENTER** button is pressed while the last digit is highlighted, the screen will update to display the confirmation dialog (described previously).

4.3.11.4.8 Min Run

If 'Min Run' is activated from the Alarm sub-menu, then the display will be updated to show the following editing screen.

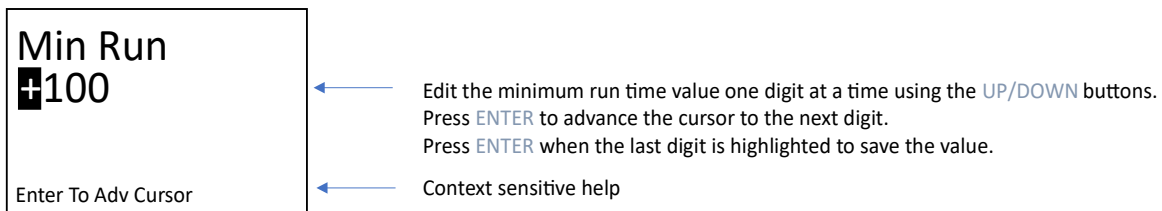

When the **ENTER** button is pressed while the last digit is highlighted, the screen will update to display the confirmation dialog (described previously).

4.3.11.5 Transmitter Relay Settings

From the UTx service menu, selecting 'Relays' will update the display to show the following sub-menu.

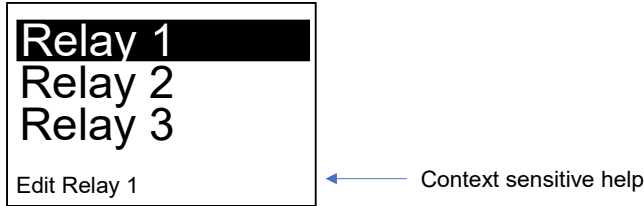

The **UP** and **DOWN** buttons can be used to navigate the list of menus for the Alarms sub-menu. The following table outlines all the menu items from the Alarms sub-menu:

Menu Item	Description
Relay 1-5	Selecting this menu item to activate the configuration sub-menu for the selected relay (ranging from 1 to 5).
Exit	Select this menu item to return to the UTx service menu. The Relays menu item will be selected when the UTx service menu appears.

Selecting a relay from the alarms sub-menu will update the display to show the following:

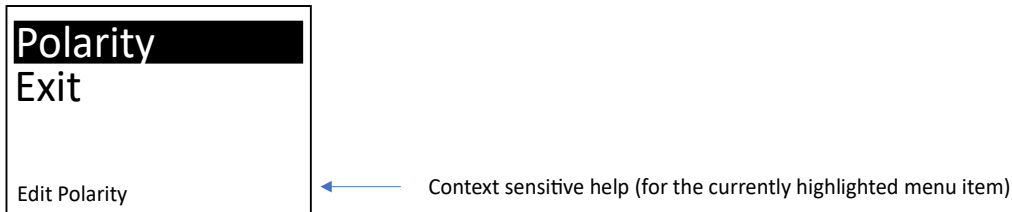

The table below outlines all the menu items from the relay sub-menu:

Menu Item	Description
Polarity	Select this menu item to edit the relay's polarity setting.
Exit	Select this menu item to return to the Relays sub-menu.



AMC-1BZx Gas Monitor

If 'Polarity' is activated from the relay sub-menu, then the display will be updated to show the following editing screen.

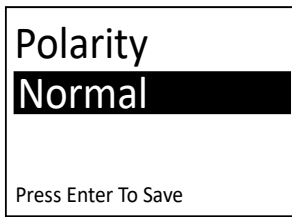

- ← 'Polarity' serves as a label only.
- ← The polarity can be selected from a list of options using the UP/DOWN buttons to cycle between each option. Press ENTER to save the selected options.
- ← Context sensitive help

The available options for 'Polarity' are listed in the table below:

Menu Item	Description
Normal	Relay coil is energized when associated alarm is active. Otherwise, the relay coil is de-energized.
Reverse	Relay coil is de-energized when associated alarm is active. Otherwise, the relay coil is energized.

When the **ENTER** button is pressed, the screen will update to display the confirmation dialog (described previously).

NOTE: The monitor system configuration is factory-set to use the reverse setting for the fail-safe mode. Fail safe mode provides continuity between COM to NC during WARN/ALARM/FAULT and power failure, and the associated relay LED indicator will be off.



4.3.11.6 Outputs

Analog output configuration is handled via the Outputs menu available from the main service menu. With the Outputs menu it is possible to configure the analog output to use multiplexed sensor sources to determine the output response; this section concludes with an example. Once in the Outputs menu, the **UP** and **DOWN** buttons can be used to navigate the list of available analog outputs to be configured.

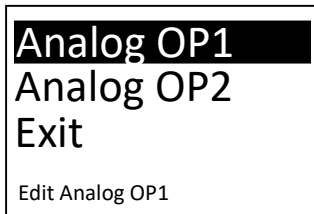

← Context sensitive help (for the currently highlighted menu item)

Table 4-21: Outputs Sub-Menu

Menu Item	Description
Source	Allows the analog output channel to be driven based on desired gas sources. With this menu item, it is possible to multiplex several of the available gases together to drive the output.
Mode	Used to select between voltage or current analog output modes.
Range	Can be used to adjust the output range. The units in the menu are either V or mA, depending on the selection chosen with the Mode menu item.

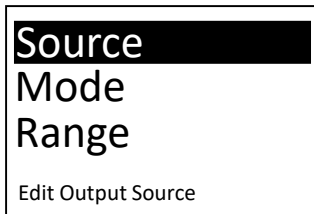

← Context sensitive help (for the currently highlighted menu item)

4.3.11.6.1 Source

When the **ENTER** button is pressed with Source selected, the list of available gases will be presented. A checkbox to the left of each gas label indicates if a gas is being used in the calculation of the analog output.

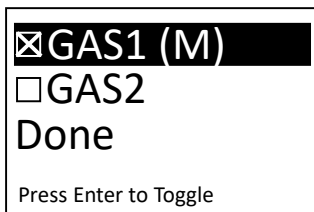

← Context sensitive help (for the currently highlighted menu item)



AMC-1BZx Gas Monitor

To the right of each enabled gas an “M” or “A” in brackets denotes which gas concentration is used in scaling the output response. The “M” indicates that the maximum supported gas concentration of the sensor is used in scaling the output response. An “A” indicates that the gas concentration tied to the high alarm (Alarm SP 3, see the ‘**Transmitter Sensor Settings**’ section, is used as max scale in the calculation of the analog output response.

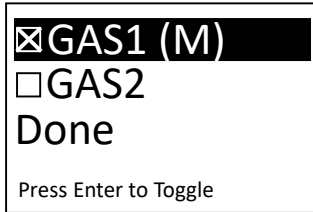

← Context sensitive help (for the currently highlighted menu item)

When the **ENTER** button is pressed with an unchecked gas selected, a screen will be presented to allow the selection between the max gas concentration (“MAX”) or Alarm SP 3 (“HI ALARM”). Use the **UP** and **DOWN** buttons to select between the two options, and press **ENTER** to confirm the selection. This will cause a return to Source sub-menu with the gas as checked. Pressing the **ENTER** button on an already checked gas will cause it to become unchecked and clear the “M” or “A” setting.

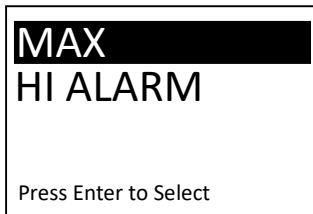

← Press UP/DOWN to toggle between options.

← Context sensitive help (for the currently highlighted menu item)

4.3.11.6.2 Mode

From the Outputs menu, when the **ENTER** button is pressed with Mode selected, a menu option to select between and analog output mode of voltage or current will be presented. Use the **UP** and **DOWN** buttons to select between the two options, and press **ENTER** to confirm the selected mode.

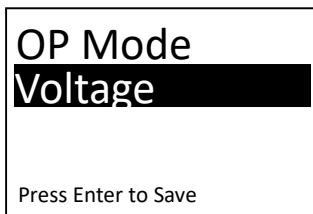

← Press UP/DOWN to toggle between voltage and current output modes.

← Context sensitive help (for the currently highlighted menu item)

4.3.11.6.3 Range

From the Outputs menu, when the **ENTER** button is pressed with Range selected, a sub-menu to configure the minimum and maximum analog output response will become available. The engineering unit (V or mA) displayed in the Output Min/Max menu items will reflect the analog output mode selected with the Mode menu item.

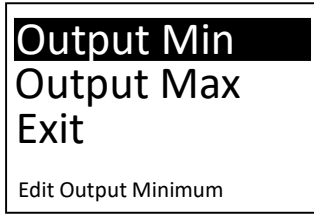

← Context sensitive help (for the currently highlighted menu item)

The permitted analog output range for voltage mode is between 0-10V.

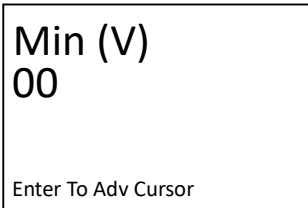

- ← 'Min (V)' serves as a label only.
- ← Edit the window filter value one digit at a time using the UP/DOWN buttons. Press ENTER to advance the cursor to the next digit. Press ENTER when the last digit is highlighted to save the value.
- ← Context sensitive help

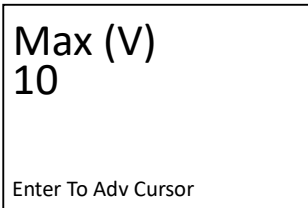

- ← 'Max (V)' serves as a label only.
- ← Edit the window filter value one digit at a time using the UP/DOWN buttons. Press ENTER to advance the cursor to the next digit. Press ENTER when the last digit is highlighted to save the value.
- ← Context sensitive help

The permitted analog output range for current mode is between 0-20mA.

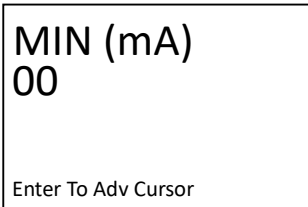

- ← 'MIN (mA)' serves as a label only.
- ← Edit the window filter value one digit at a time using the UP/DOWN buttons. Press ENTER to advance the cursor to the next digit. Press ENTER when the last digit is highlighted to save the value.
- ← Context sensitive help

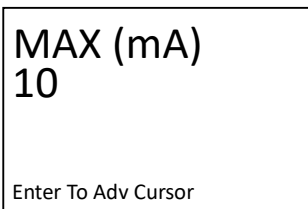

- ← 'MAX (mA)' serves as a label only.
- ← Edit the window filter value one digit at a time using the UP/DOWN buttons. Press ENTER to advance the cursor to the next digit. Press ENTER when the last digit is highlighted to save the value.
- ← Context sensitive help



Multiplexing Example

With an overview of the Outputs menu complete, it is worthwhile to show an example of how a multiplexed sensor configuration can be used to drive the analog output. In this example, the following configuration is used:

- Voltage output mode on OP1.
- 2-10V range selected for OP1.
- GAS1, with a max gas concentration of 100 PPM, and Alarm SP 3 of 100 PPM.
- GAS2, with a max gas concentration of 10 PPM, and Alarm SP 3 of 3 PPM.
- GAS1 and GAS2 are to be multiplexed; whichever gas has a higher percentage of maximum scale is to drive the output.
- GAS1 is using the max gas concentration for scaling (“M”), whereas GAS2 is using Alarm SP 3 (“A”).

Suppose GAS1 has a present reading of 7 PPM, and GAS2 has a present reading of 0.5 PPM. GAS1 has a percent of max scale of $7/100=0.07$. GAS2 has a percent of max scale of $0.5/3=0.16$. As a result, it is GAS2 that presently determines the analog output response.

The range selected for voltage mode is $(10V - 2V) = 8V$. Accounting for the output offset (Output Min) of 2V, the analog output value will be found to be $2V + 0.16 * 8V = 3.33 V$.

4.3.11.7 Buzzer

From the UTx service menu, selecting ‘Buzzer’ will update the display to show the following:

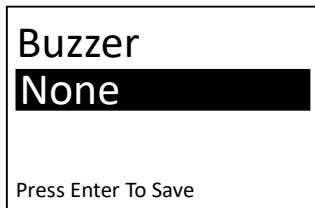

← ‘Buzzer’ serves as a label only.

← The buzzer activation level can be selected from a list of options using the UP/DOWN buttons to cycle between each option. Press ENTER to save the selected options.

← Context sensitive help

The available options for ‘Buzzer’ are listed in the table below:

Table 4-22: Buzzer Menu

Menu Item	Description
None	Disable local buzzer completely.
Alarm	Local buzzer sounds for alarm level and fault.
All Levels	Local buzzer sounds for warning, alarm, high alarm levels, and fault.

4.3.11.8 Acknowledgement Timer

From the UTx service menu, selecting 'Ack Timer' will update the display to show the following:

- ← 'Ack Timer' serves as a label only.
- ← Edit the activation timer value one digit at a time using the UP/DOWN buttons. Press ENTER to advance the cursor to the next digit. Press ENTER when the last digit is highlighted to save the value.
- ← Context sensitive help

When the **ENTER** button is pressed while the last digit is highlighted, the screen will update to display the confirmation dialog (described previously).

The allowable values for the activation timer are 30-120 seconds. During an alarm state, the local buzzer may be silenced for a period equal to activation timer, by pressing the **ENTER** button.

4.3.11.9 RTC Date & Time

The main service menu Date and Time items can be used to update the on-board real-time clock (RTC). The RTC runs on battery power when main power is unavailable. These menus provide a mechanism to update the date and time, for example, in the event of low battery during a power outage.

Use the **UP** and **DOWN** buttons to scroll through available year, month, and day options. A short press of the **ENTER** button will advance to the next digit. A long press of the **ENTER** button will return to the previous digit. Press the **ENTER** button on the last digit to proceed to the confirmation Save dialog.

- ← 'YY-MM-DD' serves as a label only.
- ← Context sensitive help

Button presses for Time menu behave in the same manner as the Date menu. Note that it is only possible to update the RTC hour and minute currently.

- ← 'HH:MM' serves as a label only.
- ← Context sensitive help

5 Maintenance

5.1 General

Maintenance is a crucial activity that should be done at the proper time intervals, which are discussed below.

The AMC-1BZ should be cleaned (brushed or wiped) as required, depending on the rate of accumulation of any dust or dirt.

To avoid damage, the unit **MOST NOT** be submerged, hosed, or splashed with any liquids. Ensure the green indicators (LEDs) are slowly blinking to indicate a healthy state.

5.2 Verification of Operation

Verification of operation should be performed at least once every 6 months. For highly demanding applications more frequent verification is recommended.

5.2.1 LED/Relay Activation Test

The Main Service Menu allows the activation of all relays and LEDs, regardless of alarm state. This may be useful during system configuration to verify operation of the LEDs and relays, as well as to verify that the polarity settings are correct.

From the Main Service Menu, selecting 'Test' will update the display to show the following:

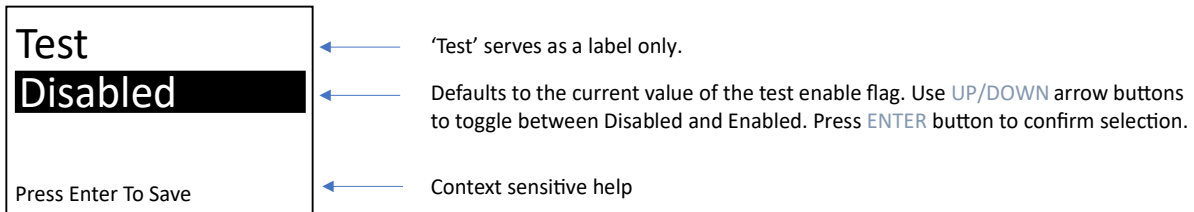

When the **ENTER** button is pressed, the confirmation screen (described previously) is displayed.

In addition to activating all relays (taking into account polarity settings), all display LEDs will appear solid white, if functional.



6 Troubleshooting

6.1 Symptoms and Corrective Actions

Table 6-1: Troubleshooting

Symptom	Possible Cause	How to Verify	Corrective Action
Buzzer or Relays Not Activating.	Bad Connection to Buzzer or Relays.	No continuity between COM and NO Bus Module terminals.	Re-seat wiring connections for buzzer and relay coils.
	Configuration Incorrect.	No continuity between Relay Coil connection and Relay Coils.	Check UTx > Buzzer menu parameters. Check if either Alarm or All Levels are selected in item.
			Check UTx > Alarms > Alarm 1/2/3/4 > Output menu parameters; ensure Relays 1 and 2 are checked (enabled). Note: For 1BZ2 Only: Ensure Relays 1, 2, 3 and 4 are checked (enabled).
			The Relay 1 coil is energized during the WARN state for AI1, while the Relay 2 coil is energized during the ALARM state for AI1. Note: For 1BZ2 Only: The Relay 3 coil is energized during the WARN state for AI2, while the Relay 4 coil is energized during the ALARM state for AI2.
			Alarm 1 is used to control Relay 1 for AI1. Alarm 2 is used to control Relay 2 for AI1. Note: For 1BZ2 Only: Alarm 3 is used to control Relay 3 for AI2. Alarm 4 is used to control Relay 4 for AI2.

7 Menu Flow Diagrams

7.1 Main Screen / Password Flow

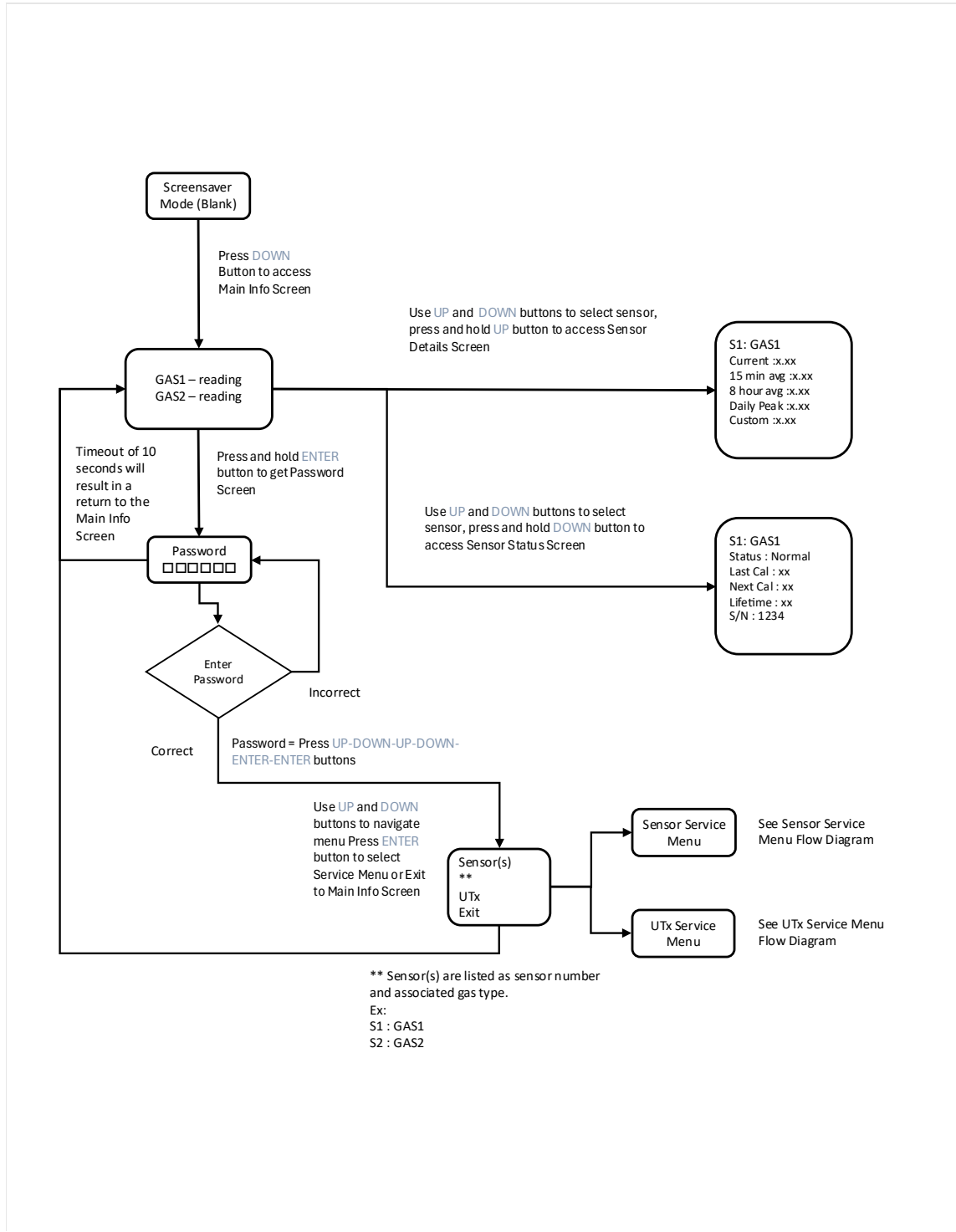

Figure 7-1: Main Screen / Password Flow

7.2 UTx Service Menu

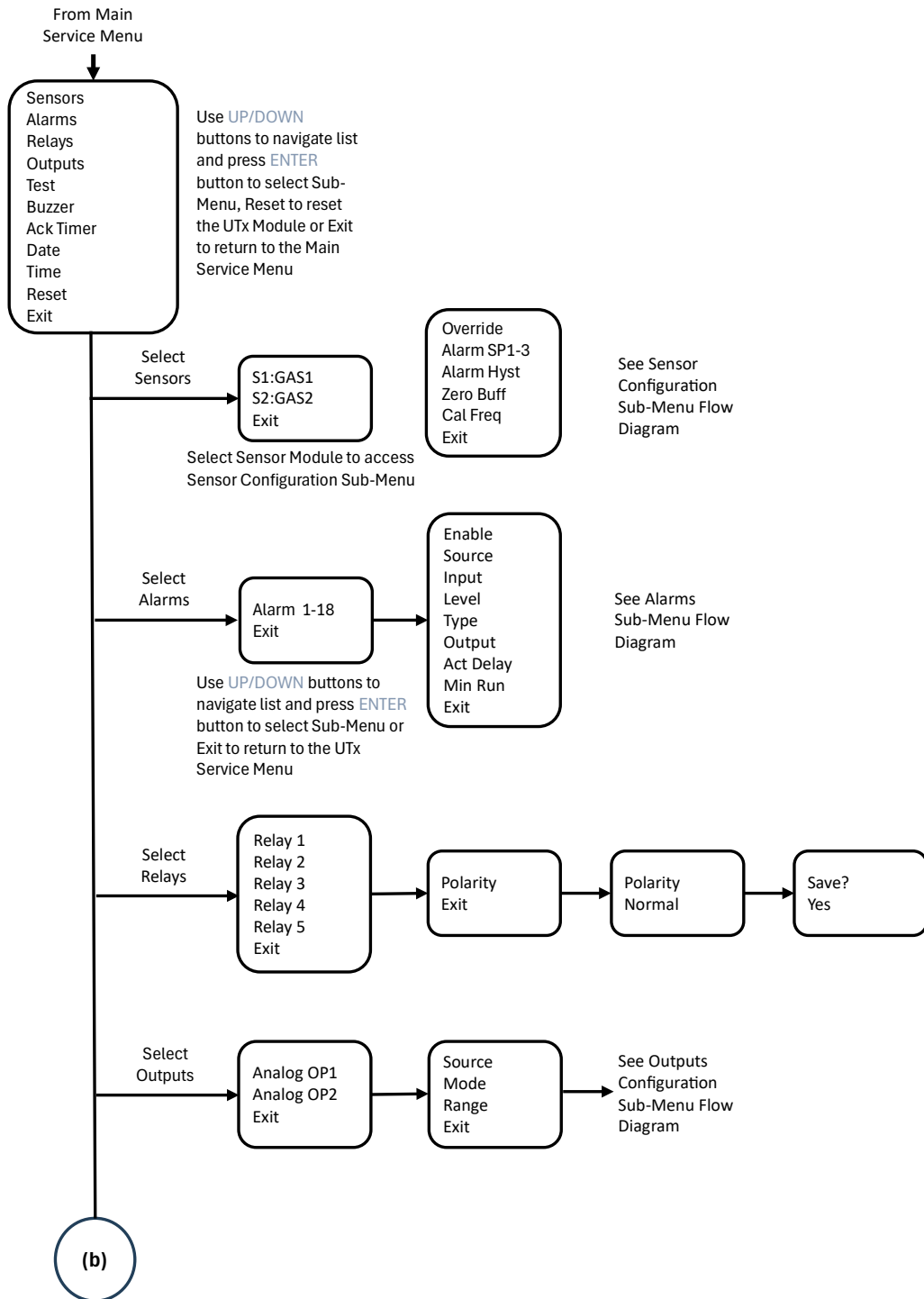

Figure 7-2: UTx Service Menu (a)

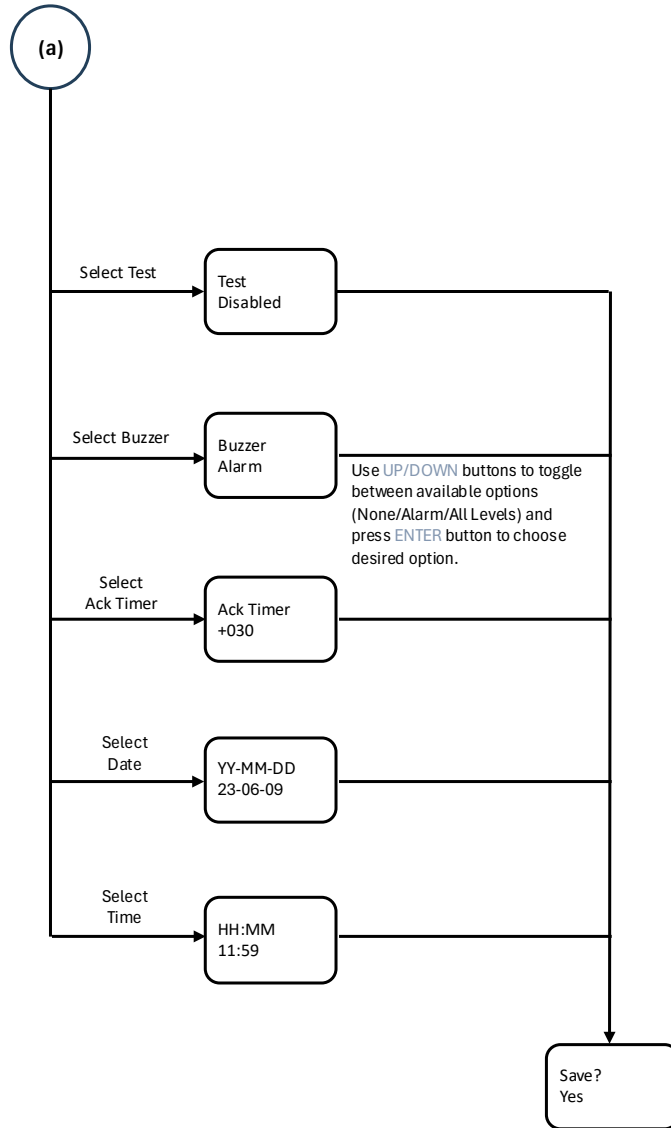

Figure 7-3: UTx Service Menu (b)

7.3 Sensor Service Menu

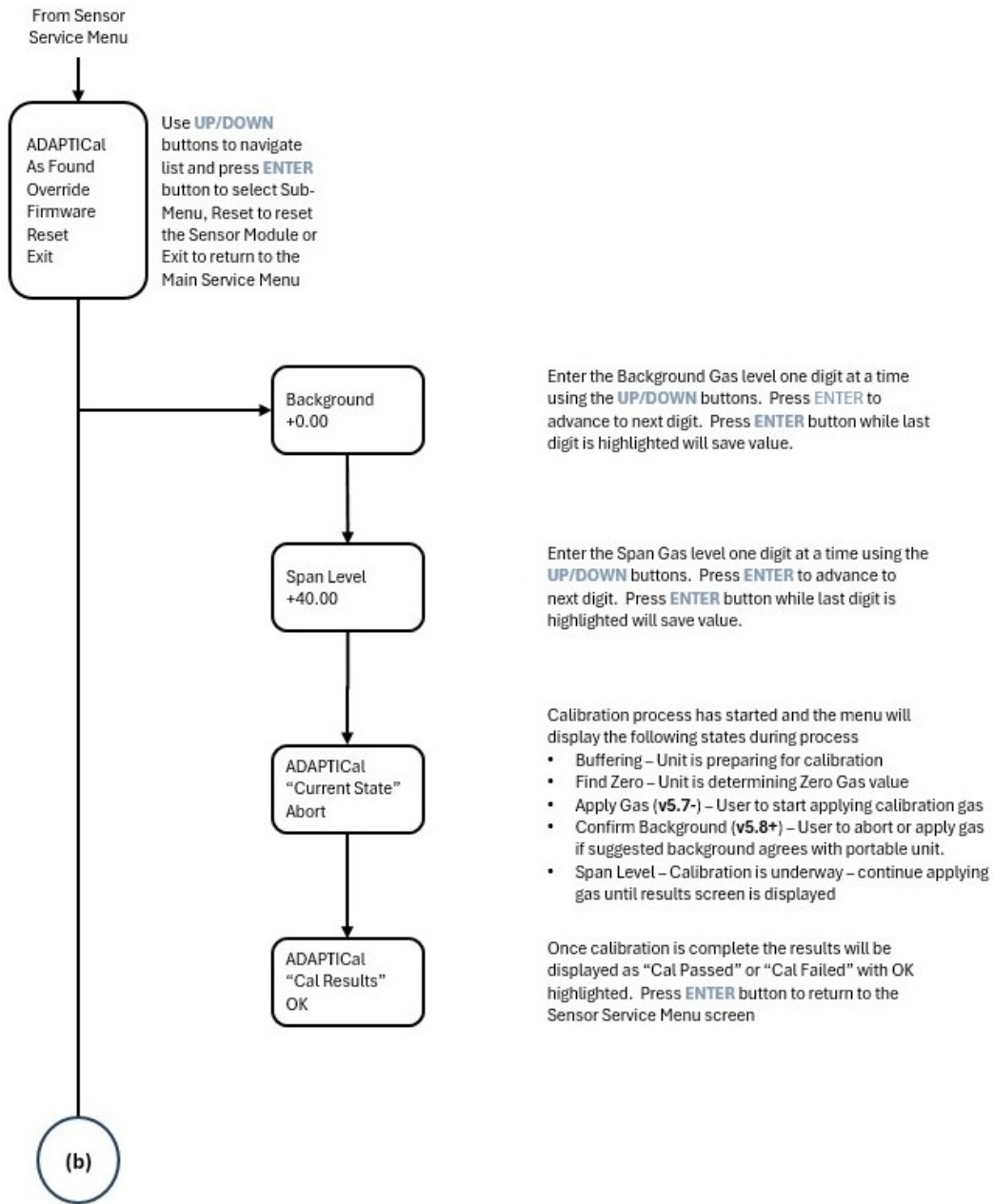

Figure 7-4: Sensor Service Menu Diagram (a)

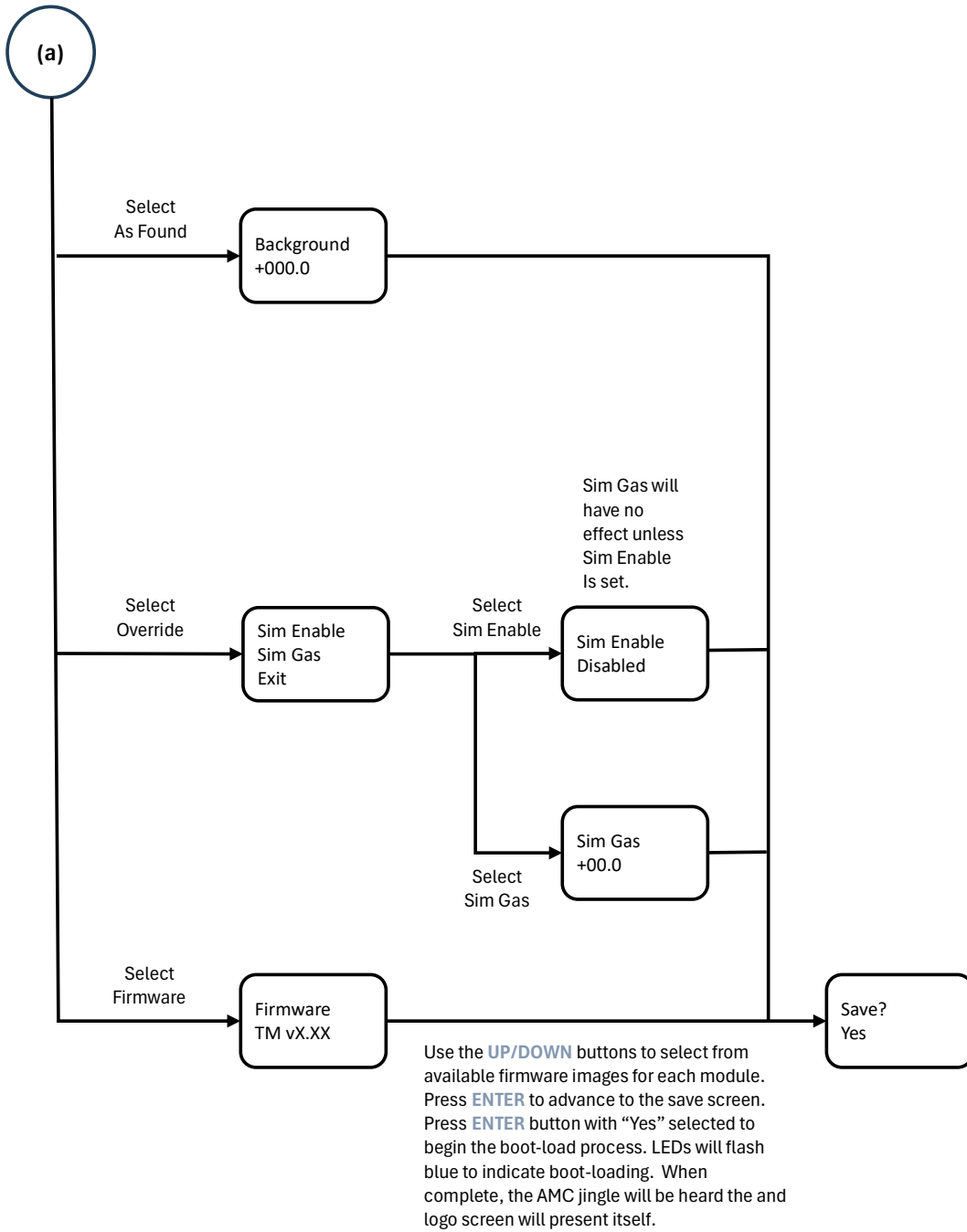

Figure 7-5: Sensor Service Menu Diagram (b)

7.4 Alarm Menu

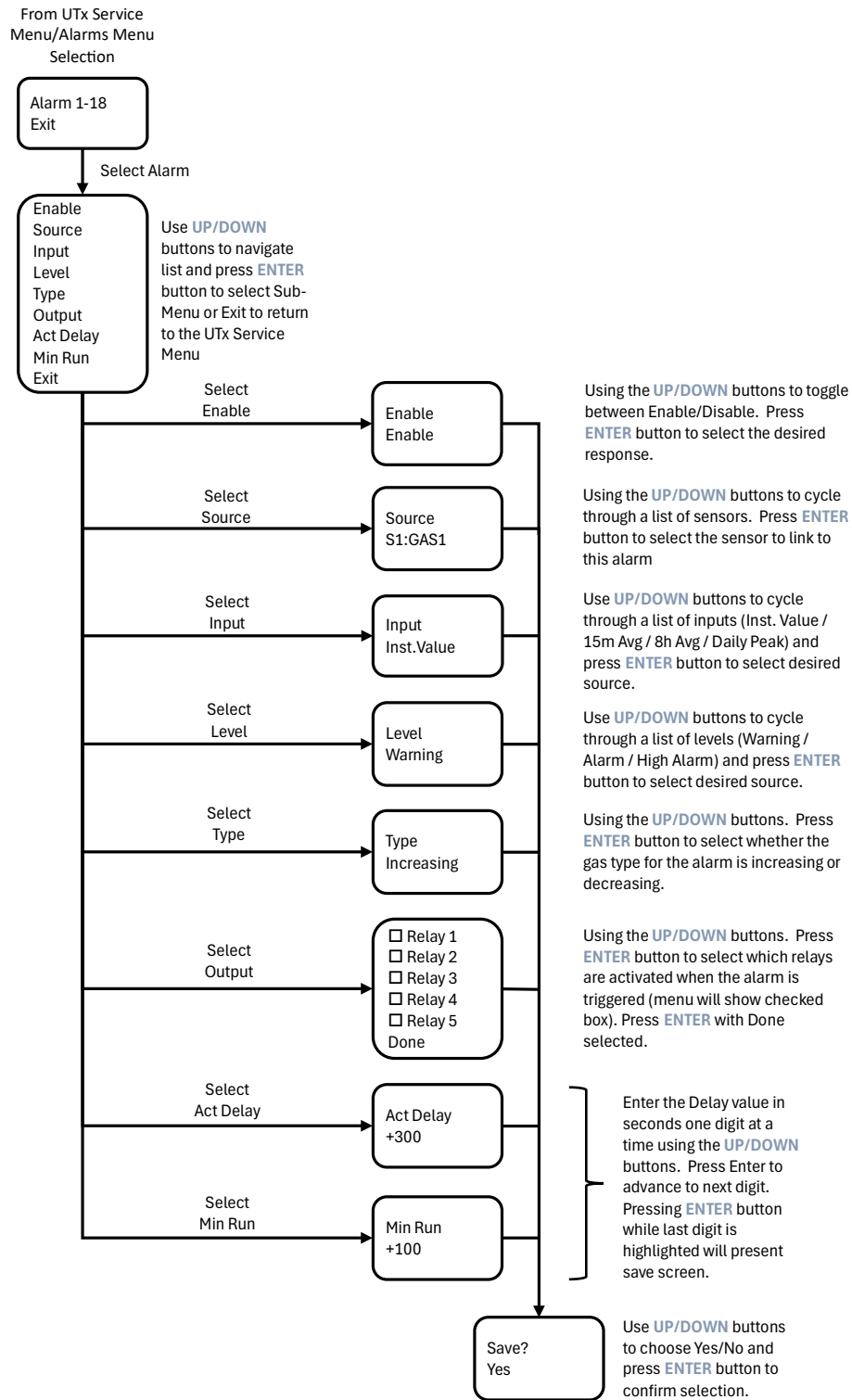

Figure 7-6: Alarm Menu Flow Diagram

7.5 Outputs

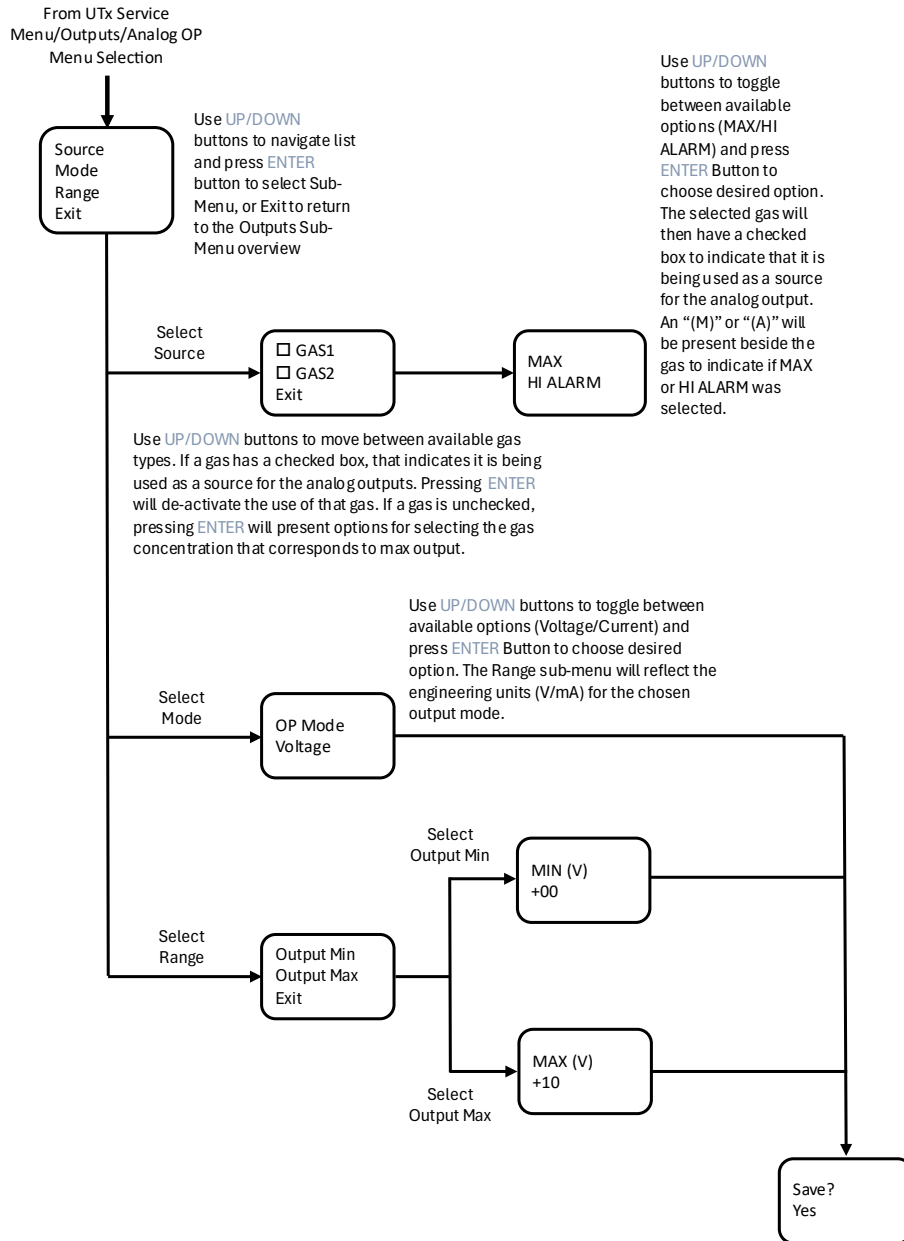

Figure 7-7: Outputs Menu Flow Diagram



8 Revision History

8.1 Document Revision History

Table 8-1: Document Revision History

Revision	Release Date	Change Description	Affected Section(s)
A	December 2025	Initial Release	
B	December 2025	Custom window option removed.	Transmitter Service Menu – Alarm Sub-Menu Calibration Procedure - Menu
		Correction to timeout duration from 30s to 300s.	Detailed Sensor Screen Detailed Status Screen
		Addition of “Quick Info” section.	Menu Overview
		Addition of alternative “Override”.	Sensor Alarm Configuration Sub-Menu
		Image and verbiage updated to be more generic.	Transmitter Service Menu – Alarm Sub-Menu - Output
C	March 2026	Corrections to diagrams.	Menu Flow Diagrams