



# AMC-103X Series

## Gas Monitor

# USER MANUAL



3550411B

Copyright © 2026 AMC

---

### The Armstrong Monitoring Corporation

215 Colonnade Road South, Ottawa, Ontario, Canada K2E 7K3

Tel: (613) 225 9531 • Fax: (613) 225 6965 • Canada & U.S. Toll Free: 1 (800) 465 5777

Email: support@armstrongmonitoring.com • Website: www.armstrongmonitoring.com

---



## Table of Contents

<b>1. General Information .....</b>	<b>8</b>
1.1 Warranty .....	8
1.2 Liability .....	8
1.3 Product Return .....	8
1.4 Contact Information .....	8
1.5 Modifications and Substitutions.....	9
1.6 Glossary.....	9
<b>2. Product Specifications .....</b>	<b>10</b>
2.1 AMC-103X Monitor .....	10
2.2 Sensor Module .....	10
2.2.1 Carbon Monoxide .....	10
2.2.2 Carbon Monoxide/Nitrogen Dioxide .....	11
2.2.3 Propane .....	11
2.3 Product Description.....	12
2.4 External View .....	13
2.5 Internal View .....	14
2.6 Accessories .....	14
<b>3. Installation.....</b>	<b>15</b>
3.1 Overview.....	15
3.2 Monitor Mounting .....	15
3.3 Remote AMC-3707 Propane Sensor Mounting .....	17
3.4 Wiring .....	18
3.4.1 Power Supply.....	18
3.4.2 Relays .....	18
3.4.3 AMC-3707 Remote Sensor .....	19
<b>4. Operation.....</b>	<b>20</b>
4.1 Overview .....	20
4.2 Status LEDs.....	20
4.2.1 Start Up.....	20
4.2.2 Network Status .....	20



- 4.2.3 Faults .....20
- 4.2.4 Alarms .....21
- 4.2.5 Calibration .....22
- 4.2.6 Miscellaneous .....22
- 4.3 Menu Overview.....23
  - 4.3.1 Normal Operation .....23
  - 4.3.2 Failed Sensor .....23
  - 4.3.3 Warning/Alarm Indication.....24
  - 4.3.4 Fault Indication .....26
  - 4.3.5 Detailed Sensor Screen.....26
  - 4.3.6 Detailed Status Screen.....26
  - 4.3.7 Quick Info Screen .....27
  - 4.3.8 Password Entry .....28
  - 4.3.9 Main Service Menu .....28
    - 4.3.9.1 Service Menu Timeout.....28
    - 4.3.9.2 Service Menu Overview .....28
  - 4.3.10 External Sensor Service Menu .....29
    - 4.3.10.1 External Sensor Service Menu Overview .....30
    - 4.3.10.2 Analog Sub-Menu .....30
    - 4.3.10.3 Sensor Sub-Menu .....32
    - 4.3.10.4 Gas Label .....32
    - 4.3.10.5 Engineering Units.....33
    - 4.3.10.6 Simulation Of Gas Levels (External Sensors).....33
    - 4.3.10.7 Override .....34
    - 4.3.10.8 Sim Enable .....34
    - 4.3.10.9 Sim Gas.....34
  - 4.3.11 Transmitter Service Menu.....35
    - 4.3.11.1 Transmitter Sensors Settings .....36
    - 4.3.11.2 Sensor Alarm Configuration Sub-Menu .....36
    - 4.3.11.3 Transmitter Alarms Settings .....40
    - 4.3.11.4 Alarm Sub-Menu .....40



4.3.11.5 Transmitter Relay Settings .....	44
4.3.11.6 Outputs .....	46
4.3.11.7 Buzzer .....	50
4.3.11.8 Acknowledgement Timer .....	50
4.3.11.9 RTC Date & Time .....	50
4.3.12 Calibration .....	51
4.3.12.1 Required Equipment; EZ Cal Exchange Program .....	51
4.3.12.2 Required Equipment; On-Site Sensor Module Calibration .....	51
4.3.12.3 Pre Bump Test .....	52
4.3.12.4 Calibration Procedure – Menu .....	53
4.3.12.5 Calibration Procedure – Routine .....	55
<b>5. Maintenance .....</b>	<b>57</b>
5.1 General .....	57
5.2 Scheduled Calibration .....	57
5.3 Sensor Module .....	57
5.3.1 Sensor Module Replacement .....	57
5.3.1.1 Remove Sensor Module .....	57
5.3.1.2 Install Sensor Module .....	58
5.4 Verification of Operation .....	58
5.4.1 Simulation of Gas Levels .....	58
5.4.2 LED/Relay Activation Test .....	59
<b>6. Troubleshooting .....</b>	<b>60</b>
6.1 Symptoms and Corrective Actions .....	60
<b>7. Sensor Module Default Settings .....</b>	<b>61</b>
7.1 Default Alarm Settings .....	61
7.2 Default Sensor Module Settings .....	61
<b>8. Menu Flow Diagrams .....</b>	<b>62</b>
8.1 Main Screen / Password Flow .....	62
8.2 UTx Service Menu .....	63
8.3 Sensor Service Menu .....	65
8.4 Sensor Configuration .....	67



8.5 Alarm Menu.....68

8.6 Outputs.....69

**9. Revision History ..... 70**

9.1 Document Revision History.....70



## List of Figures

Figure 2-1: External View .....	13
Figure 2-2: Internal View .....	14
Figure 3-1: Enclosure Mounting.....	16
Figure 3-2: AMC-3707 Mounting .....	17
Figure 3-3: Input Terminal Blocks and Wiring to AMC-3707 .....	18
Figure 3-4: Relay Connections .....	19
Figure 8-1: Main Screen / Password Flow.....	62
Figure 8-2: UTx Service Menu (a).....	63
Figure 8-3: UTx Service Menu (b).....	64
Figure 8-4: Sensor Service Menu Diagram (a) .....	65
Figure 8-5: Sensor Service Menu Diagram (b) .....	66
Figure 8-6: Sensor Configuration Menu Flow Diagram.....	67
Figure 8-7: Alarm Menu Flow Diagram.....	68
Figure 8-8: Outputs Menu Flow Diagram .....	69



## List of Tables

Table 3-1: AMC 3707-Wiring .....	19
Table 4-1: Status LEDs (Start Up) .....	20
Table 4-2: Status LEDs (Network Status) .....	20
Table 4-3: Status LEDs (Faults) .....	20
Table 4-4: Status LEDs (Alarms).....	21
Table 4-5: Status LEDs (Calibration).....	22
Table 4-6: Status LEDs (Miscellaneous) .....	22
Table 4-7: Service Menu Options.....	29
Table 4-8: External Sensor Menu Options .....	30
Table 4-9: Analog Sub-Menu Options .....	30
Table 4-10: Sensor Sub-Menu Options .....	32
Table 4-11: Engineering Unit Options .....	33
Table 4-12: External Override Sub-Menu Options.....	33
Table 4-13: Transmitter Service Menu Options.....	35
Table 4-14: Sensor Module Configuration Menu.....	36
Table 4-15: Sensor Alarm Configuration .....	36
Table 4-16: Calibration Frequency Configuration .....	39
Table 4-17: Transmitter Alarm Settings.....	40
Table 4-18: Transmitter Alarm Sub-Menu Settings .....	41
Table 4-19: Alarm Input Options.....	42
Table 4-20: Alarm Setpoint Options .....	42
Table 4-21: Alarm Type Options .....	43
Table 4-22: Relay Menu .....	45
Table 4-23: Relay Sub-Menu .....	45
Table 4-24: Relay Polarity Menu .....	46
Table 4-25: Outputs Sub-Menu .....	46
Table 4-26: Buzzer Menu .....	50
Table 6-1: Troubleshooting Table .....	60
Table 7-1: Default Alarm Settings .....	61
Table 7-2: Default Sensor Module Settings .....	61
Table 9-1: Document Revision History.....	70



# 1. General Information

## 1.1 Warranty

This product is warranted against defects in material and workmanship for a period of two years from date of delivery. Maintenance items are not warranted. During the warranty period, *The Armstrong Monitoring Corporation* will repair or replace components that prove to be defective in the opinion of AMC. Any equipment deemed to be defective by the user should be returned to *The Armstrong Monitoring Corporation* for evaluation (see product return below). Site visits by Armstrong personnel, to evaluate/repair equipment, are not covered by this warranty unless covered under the site contract. AMC is not liable for auxiliary interfaced equipment, nor for consequential damage. This warranty shall not apply to any product which has been modified in any way, which has been repaired by any other party other than a qualified technician or authorized AMC representative, or when failure is due to misuse or conditions of use.

**Note:** Extended Warranty and mail in calibration programs are available (please call 1-800-465-5777) or see our contacts page at [www.armstrongmonitoring.com](http://www.armstrongmonitoring.com)

## 1.2 Liability

All AMC products must be installed and maintained according to instructions. Only qualified personnel should install and maintain the equipment. This product must not be placed in areas with combustible gases reaching 100% LEL (environments prone to explosions).

AMC shall have no liability arising from auxiliary interfaced equipment, for consequential damage, or the installation and operation of this equipment. AMC shall have no liability for labor or freight costs, or any other costs or charges in excess of the amount of the invoice for the products.

**THIS WARRANTY IS IN LIEU OF ALL OTHER WARRANTIES, EXPRESSED OR IMPLIED AND SPECIFICALLY THE WARRANTIES OF MERCHANTABILITY AND FITNESS FOR A PARTICULAR PURPOSE. THERE ARE NO WARRANTIES THAT EXTEND BEYOND THE DESCRIPTION ON THE FACE THEREOF.**

## 1.3 Product Return

All products returned for warranty or service should be shipped by prepaid freight and will be accepted only with RMA or repair number issued by AMC.

## 1.4 Contact Information

For information, please call 1-800-465-5777, visit [www.armstrongmonitoring.com](http://www.armstrongmonitoring.com) or email directly [support@armstrongmonitoring.com](mailto:support@armstrongmonitoring.com).



## 1.5 Modifications and Substitutions

Due to an ongoing development program, AMC reserves the right to substitute components and change specifications at any time without incurring any obligations.

## 1.6 Glossary

Act Delay	The delay in seconds between the gas concentration reaching an alarm setpoint, and the corresponding alarm level activating.
Alarm	Alarm is an audible, visual, or physical presentation designed to warn the instrument user that a specific level of a dangerous gas/vapor concentration has been reached or exceeded.
Calibration	Calibration is the procedure used to adjust the instrument for proper response.
Calibration Gas	Calibration Gas is a gas of known concentration used in adjusting and testing gas detection equipment to ensure proper function and accurate readings.
Gas Concentration	Gas Concentration can be measured in: <ul style="list-style-type: none"><li>• ppm</li><li>• %LEL</li><li>• % Volume</li></ul>
Hysteresis	A user-set difference from an alarm's setpoint prevents frequent alarm activation. Hysteresis solely impacts alarm deactivation, not its activation tied to the setpoint.
LEL	Lower Explosive Limit is the lowest concentration (percentage) of a gas or a vapor in air capable of combusting in the presence of an ignition source (arc, flame, heat).
Min Run	The minimum time in seconds that an alarm state will remain active, even if the gas concentration has returned above/below the setpoint +/- hysteresis (based on a decreasing or increasing alarm type).
ppm	Parts Per Million (1% volume = 10,000ppm)
Percent by Volume	Concentration of gas in a mixture expressed as a percentage of total volume.
Span	The difference between the highest concentration and lowest concentration.
T90	Response Time in seconds to achieve 90% gas concentration reading.
T99	Response Time in seconds to achieve 99% gas concentration reading.
Zero Buffering	Zero buffering is a function of the monitor which forces the gas concentration reading to zero when sensor is exposed to low concentration of a gas. The zero buffer is indicated in the sensor specification.
Zero Gas	Zero gas is gas in which the target gas is not present. The presence of oxygen is required. Clean air is an excellent source for zero calibration. A known gas concentration can be entered during zero calibration.



## 2. Product Specifications

### 2.1 AMC-103X Monitor

System	
System Warranty Period	2 Years (Sensors Excluded)
Power Supply Requirement	120 VAC, 60 Hz, 52 VA
Relays	2x DPDT, 250 VAC, 10 A
Operating Temperature	-4° to 104° F (-20° to 40° C)
Operating Pressure	13.2 – 16.2 PSI (91.2 – 111.5 kPa)
Humidity Range	15 to 90% RH, non-condensing
Terminal Block Torque	7 inch-pounds (0.8 N-m)
Real Time Clock (RTC)	
Battery Size	CR1025, Field Replaceable
Expected Battery Life	> 2 Years

Sensor		Type of Gas	Alarm Trip Points	
No.	Part No.		Warning/Ch1	Alarm/Ch2
Ch1	AMC-SM-91A01	CO	25ppm	100ppm
Ch1	AMC-SM-VCA01	CO	25ppm	100ppm
		NO <sub>2</sub>	1ppm	3ppm
Ch2	AMC-3707	Propane	20% LEL	40% LEL

### 2.2 Sensor Module

#### 2.2.1 Carbon Monoxide

Gas Type	CARBON MONOXIDE (CO)
Sensor Module Order Number	AMC-SM-91A01
Detection Range	0-100ppm
Operating Temperature	-4° to 104° F (-20° to 40° C)
Sensor Height Above Finished Floor (As part of Digital Transmitter)	4-6 Feet (1.2 – 1.8m)
Sensor Life	Up to 6 Years
Sensor Warranty	3 Years
Zero Buffering of Display	<5ppm
Calibration Kit Part Number	AMC-C1-FM1
Recommended Calibration Gas	100ppm CO
Gas Flow Rate	0.01765 cfm (0.5L/min)



## 2.2.2 Carbon Monoxide/Nitrogen Dioxide

Gas Type	CARBON MONOXIDE (CO) NITROGEN DIOXIDE (NO <sub>2</sub> )
Sensor Module Order Number	AMC-SM-VCA01
Detection Range	0-100ppm CO 0-10ppm NO <sub>2</sub>
Operating Temperature	-4° to 104° F (-20° to 40° C)
Sensor Height Above Finished Floor (As part of Digital Transmitter)	4-6 Feet (1.2 – 1.8m)
Sensor Life	Up to 6 Years CO Up to 2 Years NO <sub>2</sub>
Sensor Warranty	3 Years CO 2 Years NO <sub>2</sub>
Zero Buffering of Display	<5ppm CO <0.5ppm NO <sub>2</sub>
Calibration Kit Part Number	AMC-C1-FM1
Recommended Calibration Gas	100ppm CO 10ppm NO <sub>2</sub>
Gas Flow Rate	0.01765 cfm (0.5L/min)

## 2.2.3 Propane

Gas Type	PROPANE (C <sub>3</sub> H <sub>8</sub> )
Sensor Module Order Number	AMC-3707
Detection Range	0-50% LEL
Operating Temperature	-4° to 104° F (-20° to 40° C)
Sensor Height Above Finished Floor (As part of Digital Transmitter)	12 Inches (30 cm)
Sensor Life	5 Years
Sensor Warranty	1 Year
Zero Buffering of Display	20% LEL
Calibration Kit Part Number	AMC-C1-FH2
Recommended Calibration Gas	50% LEL C <sub>3</sub> H <sub>8</sub> Balance Air
Gas Flow Rate	0.01765 cfm (0.5L/min)

## 2.3 Product Description



The AMC-103X Gas Monitor is a two-channel gas monitoring system incorporating state of the art sensing technology using micro-controller-based design to provide continuous, reliable surveillance of surrounding air for traces of hazardous gases (listed in the above **Product Specifications** section). This unit provides independently adjustable alarms for increasing-level detection. Channel 1 indicates carbon monoxide and nitrogen dioxide alarms and channel 2 indicates propane alarms. The Sensor Module can be replaced in the field and is eligible for the EZ-CAL calibration exchange program.

## 2.4 External View

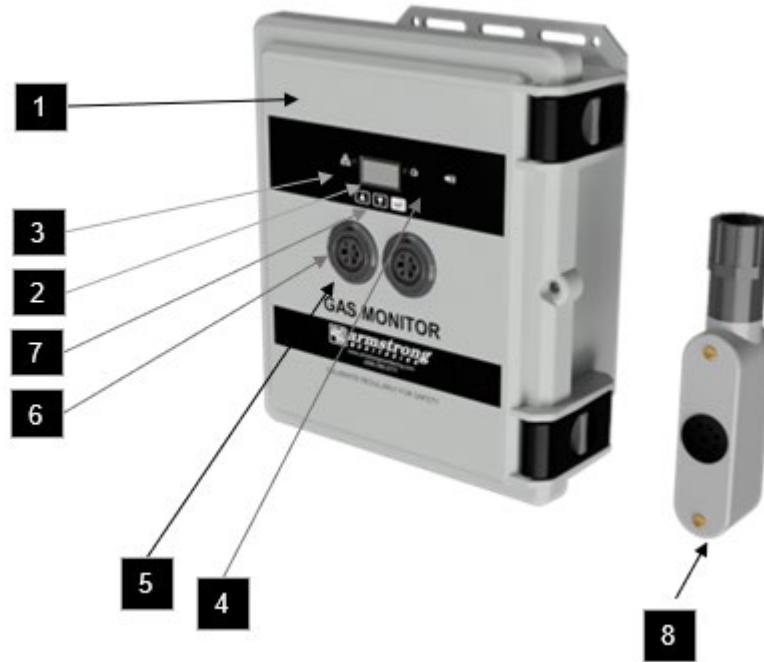

**Figure 2-1: External View**

1	Enclosure	Enclosure and Lid Assembly, UV Stabilized Polycarbonate, 11.750" L x 9.980" W X 5.460" H (300 x 250 x 140 mm). IPx5 rating with use of optional Splashguard.
2	Digital Display	Displays the gas detection state (NORM for Normal, WARN for Warning, ALARM for High Alarm).
3	Network Status LED	Not applicable to 1B Series.
4	Alarm Status LED	The Sensor Status LED will show the same error code that is being communicated by the Sensor Module(s) or display the highest priority error (if multiple errors codes are being communicated to it by the Sensor Module(s)).
5	Sensor Module Opening	This inlet allows target gas to flow into the sensor. The inlet is also used for gas calibration.
6	Sensor Module LED	Sensor Module LEDs will show the status of the sensor element within the Sensor Module, or the status of the Sensor Module itself.
7	Menu Buttons	Momentary Pushbuttons for User Interface.
8	Remote NO Sensor	AMC-3707 Remote Propane Sensor.

## 2.5 Internal View

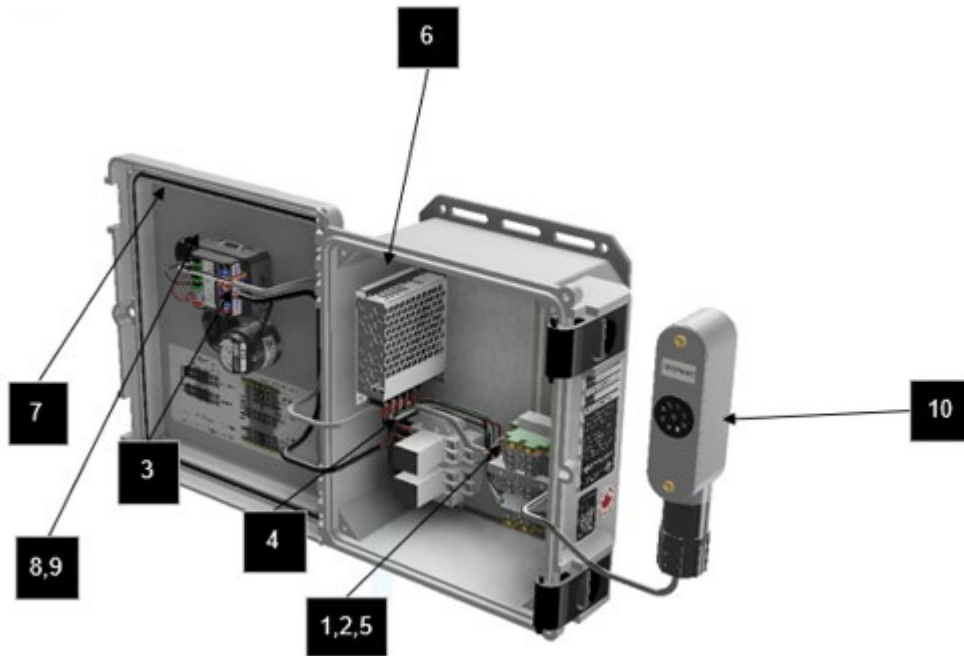

**Figure 2-2: Internal View**

1	Analog Input 1	Terminal Block for AMC-3707 Input
2	2A Fuse	Device Level Input Protection
3	Sensor Module	Contains Sensor Elements for Hazardous Gas Detection.
4	Internal Relays	Connection for Alarm/Warning System
5	Voltage IN	Terminal Block for Main Power In
6	Power Supply	Regulates Power for the Device. Present for 110VAC Input Only
7	Buzzer	Provides Audible Indication Upon Alarm State
8	UTx Main Module	Information Processing and Communications Hub
9	Bus Power Module	Provides Power and Communications Interface to the Monitor
10	AMC-3707	Remote Propane Sensor

## 2.6 Accessories

The following accessories are available for use with the AMC-103X Series Gas Monitor.

Accessory Description	Order Code
Calibration Kit	AMC-C1-FM1
Calibration Adapter	AMC-FM1
Splashguard Kit	AMC-1B-SG



## 3. Installation

### 3.1 Overview

The installation of the Gas Monitor is very important as the operational quality is a direct result of the quality of the installation. The following sections provide guidelines for installation, location and mounting, wiring, and cable selection.

### 3.2 Monitor Mounting

Care should be taken to securely fasten the monitor unit on a solid, non-vibrating surface or structure so that the Monitor is located at approximately 4ft to 6 ft (1.2m to 1.8m) above floor level or per local regulations. Mount the monitor where the unit can be observed periodically. See the below **Enclosure Mounting** figure for mounting hole locations.

**CAUTION:** All cable entry **MUST BE** through the **BOTTOM** of the monitor enclosure only. Other entry locations will allow foreign materials to enter the enclosure, causing possible damage to the internal components.

#### **WARNING**

Conduit entry from the top or back of the housing is Not Recommended. Any water damage related to conduit entry from the top or back will not be covered under warranty.

Qualified personnel should perform the installation according to applicable electrical codes, regulations and safety standards. Ensure correct cabling practices are implemented.

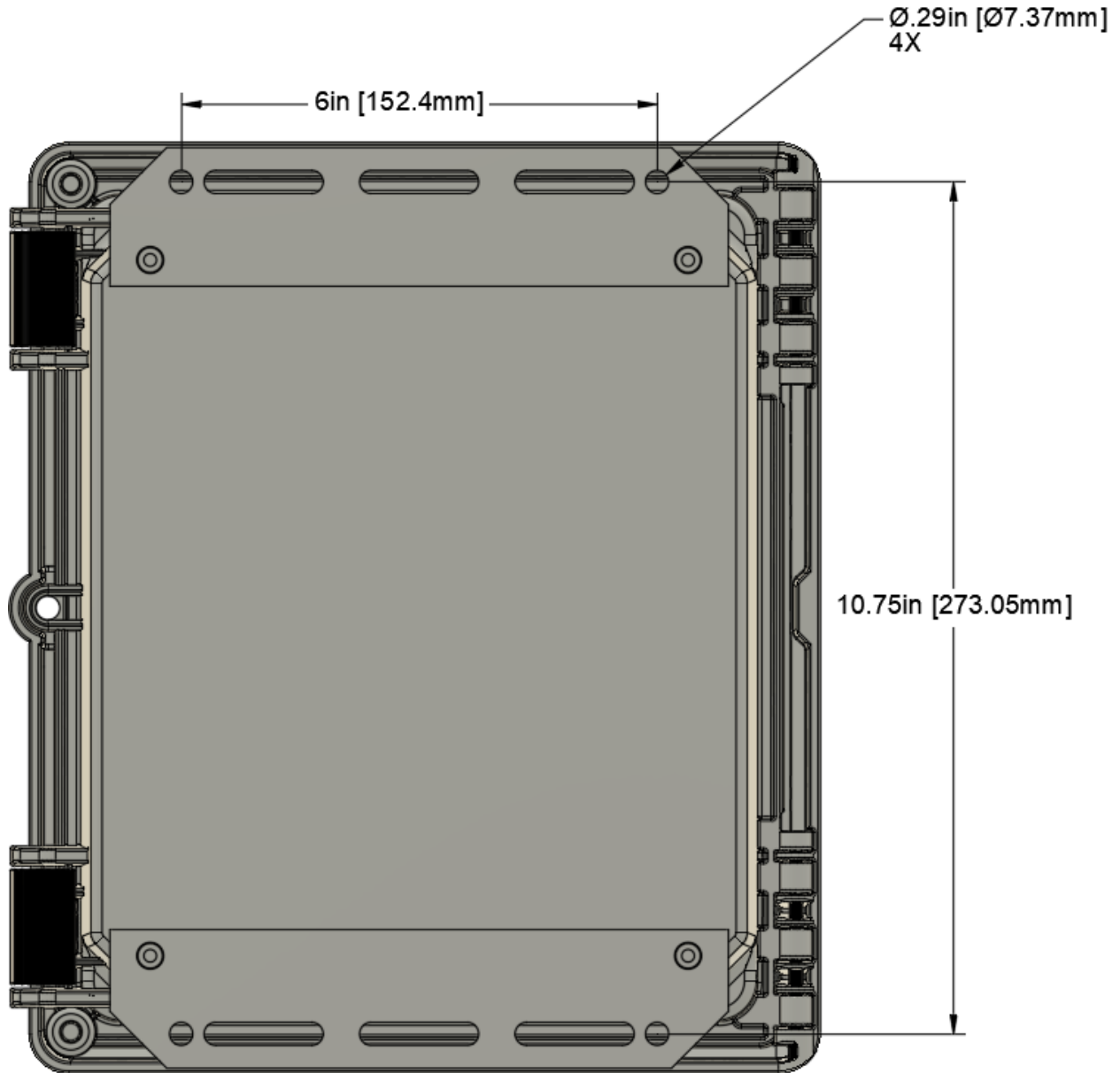

Figure 3-1: Enclosure Mounting

### 3.3 Remote AMC-3707 Propane Sensor Mounting

Mount the remote AMC-3707 propane sensor on a solid, non-vibrating surface or structure in an area where the local concentration of gas is unaffected by the presence of ventilation systems and away from sources of interference gases. The sensor should be located 12 inches (30 cm) from the floor. Local bylaws or regulations may specify mounting heights for sensors; these specifications should take precedence over factory recommendations.

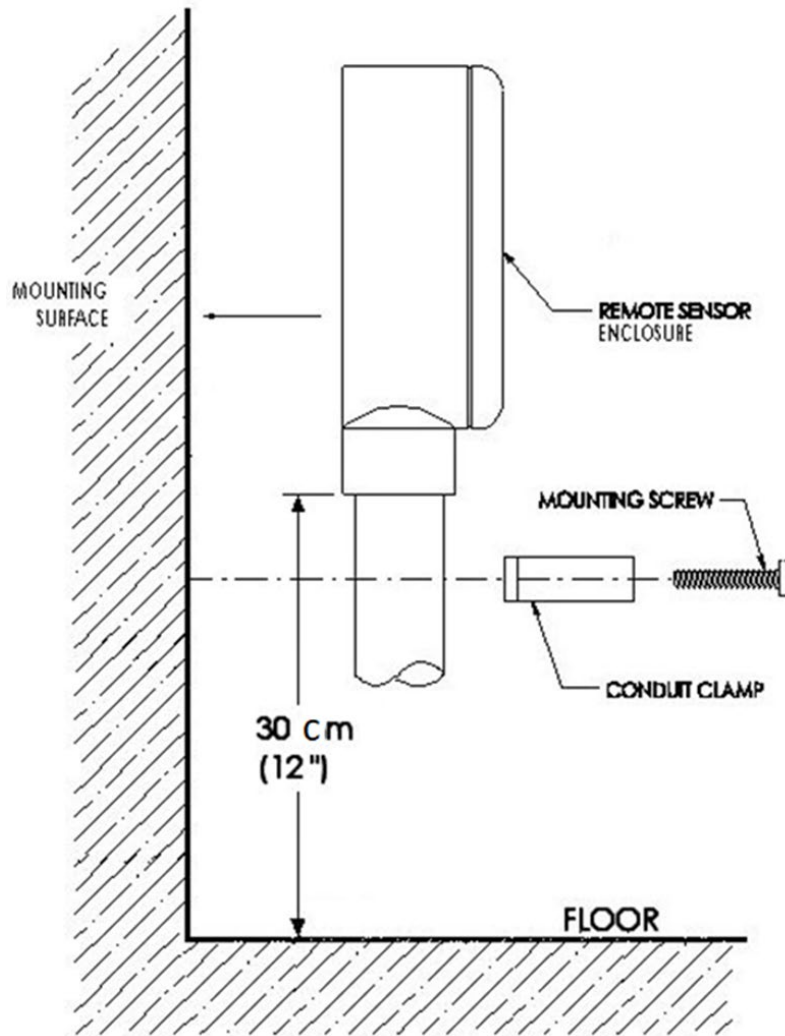

Figure 3-2: AMC-3707 Mounting

### 3.4 Wiring

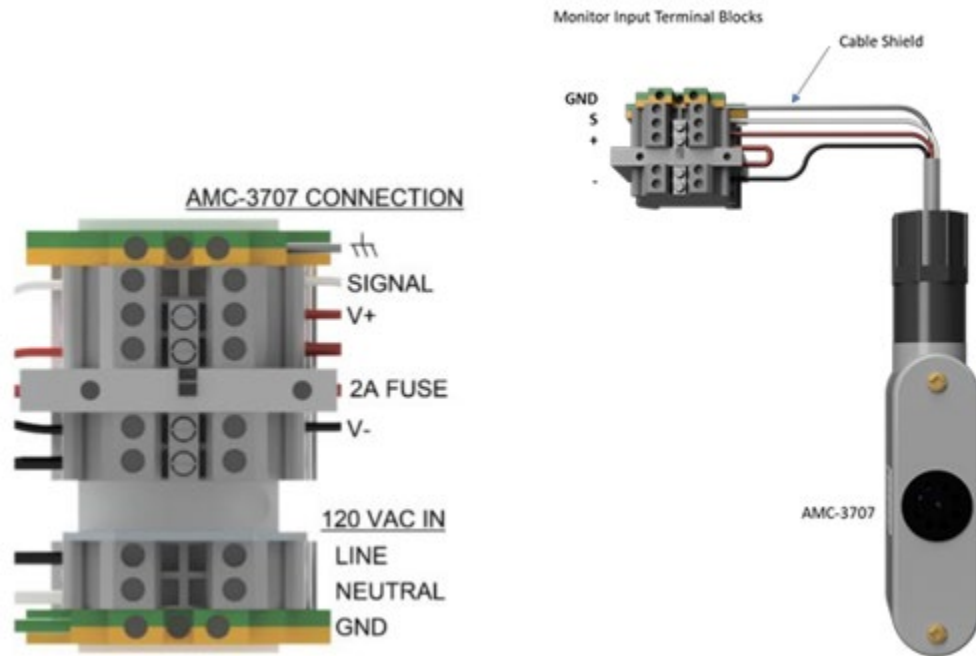

Figure 3-3: Input Terminal Blocks and Wiring to AMC-3707

#### 3.4.1 Power Supply

The monitor operates on 120 VAC, 60 Hz. The power supply connections are made at the power terminal block located inside the monitor.

All power and grounding connections to equipment must be made in accordance with applicable electrical and building codes.

For AC powered monitors, a separate, dedicated, noise free, 15 Amp power circuit, with an appropriately labelled circuit breaker is required.

#### 3.4.2 Relays

The Monitor houses 2 relays; the relay contacts are rated for 10Amps @ 28VDC/250VAC resistive. For relay contact arrangement, see below. Note that default configuration is for the relays to be energized.

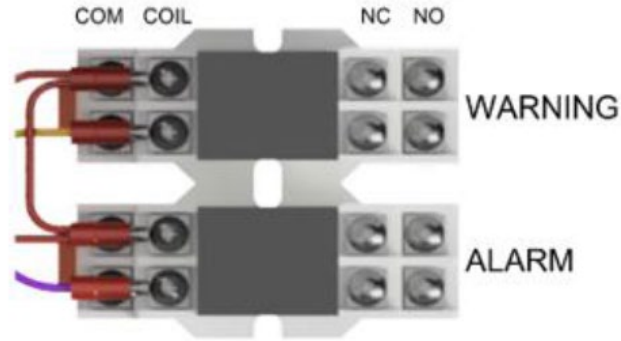

**Figure 3-4: Relay Connections**

### 3.4.3 AMC-3707 Remote Sensor

The AMC-3707 Remote Sensor is wired to the Gas Monitor through the signal input terminal blocks. The wiring is conveyed in the following table:

**Table 3-1: AMC 3707-Wiring**

Gas Monitor	AMC-3707
Chassis Ground	Connect to the Cable Shield
Negative -	Negative -
Signal S	Signal S
Positive +	Positive +



## 4. Operation

### 4.1 Overview

This section details the LED states and their corresponding meanings, as well as detailing the menu system available on AMC-103X Series Gas Monitors. Menu flow diagrams are available in the Menu Flow Diagrams section as a quick reference to those already familiar with the menu system usage.

### 4.2 Status LEDs

#### 4.2.1 Start Up

Table 4-1: Status LEDs (Start Up)

LED States	Network LED	Alarm Status LED	Sensor Module LED	Display Screen Message
Initialization and discovery of Sensor Modules (after UTx is powered up).	OFF	Solid WHITE	Solid WHITE	AMC Splash Screen
Sensor Warm-up	Flashing Green (1 sec Cycle)	Solid WHITE	Solid WHITE	Main Info Screen (or Blank)

#### 4.2.2 Network Status

Table 4-2: Status LEDs (Network Status)

LED States	Network LED	Alarm Status LED	Sensor Module LED	Display Screen Message
Network status does not apply to Standalone monitors	Flashing GREEN (1 sec cycle)			

#### 4.2.3 Faults

Table 4-3: Status LEDs (Faults)

LED States	Network LED	Alarm Status LED	Sensor Module LED	Display Screen Message
Fault 1 (ONE OR MORE OF):				
- At least one sensor has gone under range (more	Flashing GREEN (1 sec cycle)	Solid RED	Solid RED	Gas Bar Indicates "FAULT"



negative than zero blanking setting) - Bad sensor configuration				For Affected Sensors
<b>Fault 2</b>				
Corrupted Sensor Module Signal Sensor module missing. Incorrect Sensor Module Found Sensor Module Not Communicating	Flashing GREEN (1 sec cycle)	Solid RED	Solid WHITE or OFF	Gas Bar Indicates "FAIL" For Affected Sensors
<b>Fault 3</b>				
External Sensor Input Below Fault Value	Flashing GREEN (1 sec cycle)	Solid RED	Solid RED	Gas Bar Indicates "FAULT" For Affected Sensors

#### 4.2.4 Alarms

**Table 4-4: Status LEDs (Alarms)**

<b>LED States</b>	<b>Network LED</b>	<b>Alarm Status LED</b>	<b>Sensor Module LED</b>	<b>Display Screen Message</b>
Threshold 1 Reached	Flashing GREEN (1 sec cycle)	Solid YELLOW	Solid YELLOW	Gas Bar Indicates "WARN" For Affected Sensors
Threshold 2 Reached	Flashing GREEN (1 sec cycle)	Solid RED	Solid RED	Gas Bar Indicates "ALARM" For Affected Sensors
Threshold 3 Reached	Flashing GREEN (1 sec cycle)	Solid RED	Solid RED	Gas Bar Indicates "ALARM" For Affected Sensors



## 4.2.5 Calibration

Table 4-5: Status LEDs (Calibration)

LED States	Network LED	Alarm Status LED	Sensor Module LED	Display Screen Message
Cal Needed	Flashing GREEN (1 sec cycle)		Flashing CYAN and YELLOW (0.5 sec cycle)	Not Indicated on Display Screen
In Calibration Mode / Calibration Activity Waiting to Start	Flashing GREEN (1 sec cycle)		Solid CYAN	Calibration Routine Prompts
Calibration Looking for Stable	Flashing GREEN (1 sec cycle)		Flashing CYAN (0.5 sec cycle)	Calibration Routine Prompts
Calibration Pass	Flashing GREEN (1 sec cycle)		Flashing CYAN and GREEN (0.5 sec cycle)	Calibration Routine Prompts
Calibration Fail	Flashing GREEN (1 sec cycle)		Flashing CYAN and RED (0.5 sec cycle)	Calibration Routine Prompts

## 4.2.6 Miscellaneous

Table 4-6: Status LEDs (Miscellaneous)

LED States	Network LED	Alarm Status LED	Sensor Module LED	Display Screen Message
Real-Time Clock (RTC)	Flashing GREEN (1 sec cycle)	Solid MAGENTA		Not Indicated on Display Screen
Low RTC Battery	Flashing GREEN (1 sec cycle)	Flashing MAGENTA (1 sec cycle)		Not Indicated on Display Screen

## 4.3 Menu Overview

Note that a **Menu Flow Chart** is available further in this manual. The menu images and menu flow diagrams in this manual represent gas types with labels such as “GAS1”, “GAS2”, etc. These are mapped to specific gases based on the customer order.

### 4.3.1 Normal Operation

Upon startup, a brief splash screen is shown on the display which includes the Armstrong Monitoring Corp’s logo and the current version of the UTx firmware. After a couple of seconds, the display will update to show the main info screen (see below). NOTE: The bar graphs indicating gas concentration are not visible initially while the sensor modules are warming up. The warm-up period will be shown in the details section for the selected sensor until the warm-up period expires. NOTE: Factory configurations define a warm-up default value that prevents false alarms while sensors are warming up. This value may be viewed during warm-up through the detailed sensor screen section.

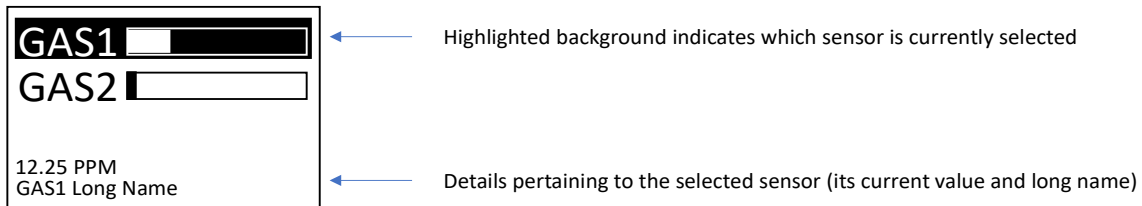

As shown above, two sensors are currently attached to the transmitter. Only one sensor can be selected at a time for the purpose of inspecting its details. Use the **UP** and **DOWN** buttons to navigate between each sensor. The following diagram illustrates the main info screen after pressing the **DOWN** button from the previous display. Notice how the details are updated to reflect the newly selected sensor.

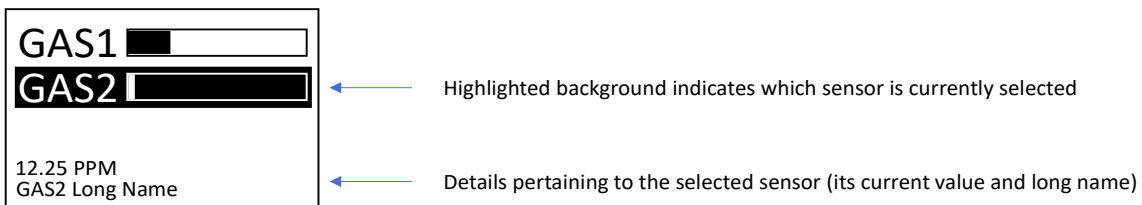

After a programmed timeout period without any button presses, the display will go blank (screen saver mode). To re-enable the display, simply press the **ENTER** button.

### 4.3.2 Failed Sensor

In the event of a failed sensor, the bar graph is replaced with a large FAIL indication, and the detailed description is updated accordingly. If the sensor fails while the display is OFF, the display will immediately turn ON and the failed sensor will be selected by default. In addition, the FAIL indication

will toggle between normal and inverse ‘white space’ mode at a rate of once per second as shown below.

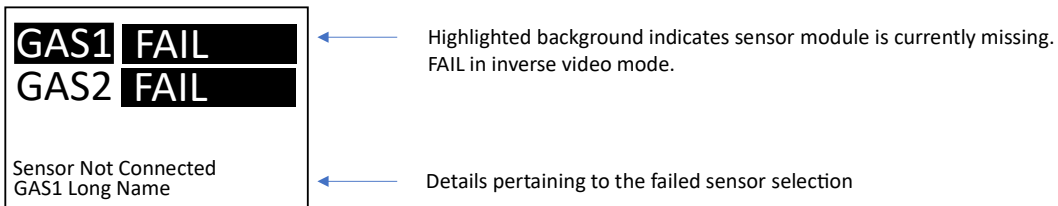
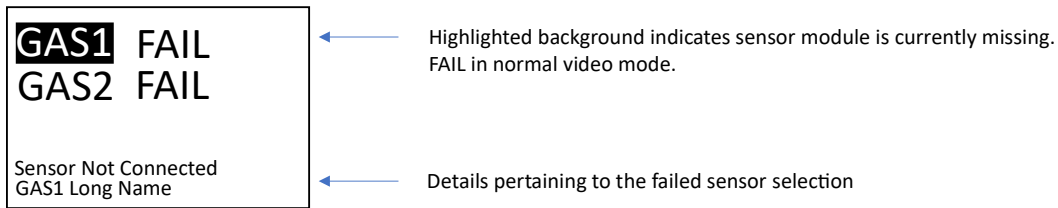

If the failure condition is resolved, the main display for the failed sensor will resume normal operation by indicating the sensor reading via bar graph.

### 4.3.3 Warning/Alarm Indication

When a warning or an alarm occurs, the bar graph is replaced with a large WARN indication for warnings or a large ALARM for alarms. If the sensor enters a warning or alarm state while the display is OFF, the display will immediately turn ON and the sensor responsible for the warning/alarm will be selected by default. Like the FAIL indication, the WARN/ALARM indication will toggle between normal and inverse ‘white space’ mode at a rate of once per second as shown below.

The user has the option to silence the buzzer while the warning/alarm condition is still active. To silence the alarm, the channel responsible for the warning/alarm needs to be selected and the user needs to press the **ENTER** button. Once silenced, the contextual help (small text) will provide an indication of how long the audio buzzer will remain silenced. Once this period expires, the previous ‘Press ENTER to ACK’ message will return, and the buzzer will resume operation.

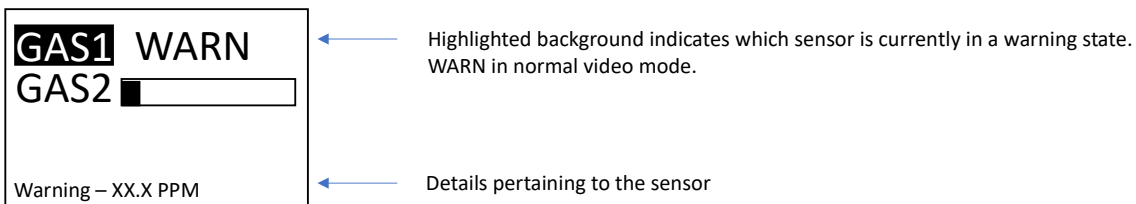

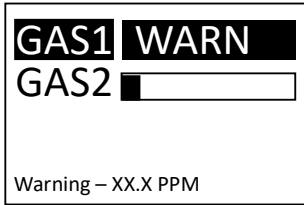

Highlighted background indicates which sensor is currently in a warning state. WARN in inverse video mode.

Details pertaining to the sensor

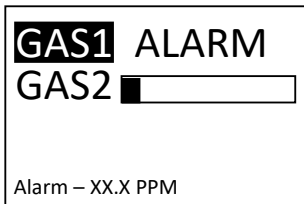

Highlighted background indicates which sensor is currently in alarm. ALARM in normal video mode.

Details pertaining to the selected sensor which is currently in alarm. The current sensor reading is shown.

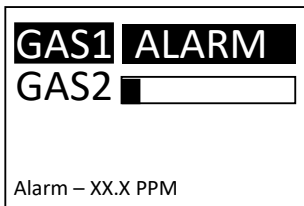

Highlighted background indicates which sensor is currently in alarm. ALARM in inverse video mode.

Details pertaining to the selected sensor which is currently in alarm. The current sensor reading is shown.

For units configured at factory to use latched alarms, when the alarm condition is cleared the display will indicate that the relays are latched until cleared by the user by pressing the **ENTER** button to release the latching condition.

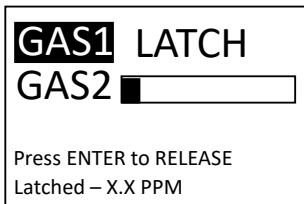

Highlighted background indicates which sensor is currently selected with latched relays. LATCH in normal video mode.

Details pertaining to the selected sensor which currently has its relays in Latched mode. The current sensor reading is shown with an instruction to press the **ENTER** button to release the relays from their active state.



Highlighted background indicates which sensor is currently selected with latched relays. LATCH in inverse video mode.

Details pertaining to the selected sensor which currently has its relays in Latched mode. The current sensor reading is shown with an instruction to press the **ENTER** button to release the relays from their active state.

### 4.3.4 Fault Indication

The following two menu images show a fault condition in normal and inverse video modes.

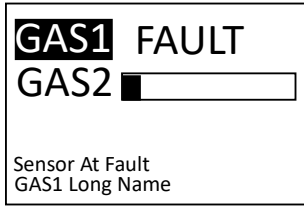

- ← Highlighted background indicates which sensor is currently at fault. FAULT in normal video mode.
- ← Details pertaining to the sensor at fault

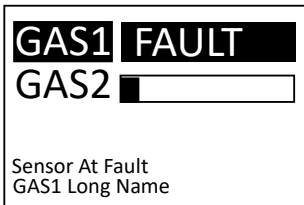

- ← Highlighted background indicates which sensor is currently at fault. FAULT in inverse video mode.
- ← Details pertaining to the sensor at fault

### 4.3.5 Detailed Sensor Screen

To access the detailed information for each sensor, press and hold the **UP** button until the following screen appears.

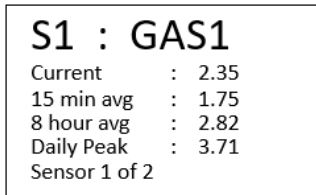

- ← Label indicates which sensor is currently selected
- ← Current instantaneous value for the selected sensor
- ← 15 min average value for the selected sensor
- ← 8 hour average value for the selected sensor
- ← Daily peak value for the selected sensor
- ← Paging info updated as different sensors are selected using UP/DOWN buttons

The detailed sensor screen provides several values for each sensor. Use the **UP** and **DOWN** buttons to page through all the attached sensors. This detailed screen will timeout after 300 seconds if no button is pressed thereby returning the user back to the main info screen. Alternatively, the user can exit the detailed sensor screen on demand by pressing the **ENTER** button to return back to the main info screen.

### 4.3.6 Detailed Status Screen

To access the detailed status for each sensor, press and hold the **DOWN** button until the following screen appears.



<b>S1 : GAS1</b>	←	Label indicates which sensor is currently selected
Status : Normal	←	Current operational status for the selected sensor
Last Cal : 76 days	←	Number of days since last calibration for the selected sensor
Next Cal : 104 days	←	Number of days until next calibration for the selected sensor
Lifetime : 2126 days	←	Remaining sensor life for the selected sensor
S/N : 1234	←	Serial number for the selected sensor
Sensor 1 of 2	←	Paging info updated as different sensors are selected using UP/DOWN buttons

The detailed status screen provides the complete status for each sensor. Use the UP and DOWN buttons to page through all the attached sensors. This detailed screen will timeout after 300 seconds if no button is pressed thereby returning the user back to the main info screen. Alternatively, the user can exit the detailed status screen on demand by pressing the ENTER button to return to the main info screen.

**NOTE:** All information dependent on the real-time clock (RTC) such as 'Last Cal' or 'Next Cal' may be incorrect if the RTC is currently disabled or uninitialized (as indicated by a solid magenta on the Alarm Status LED).

Continuing to press **DOWN** after the sensor pages show the firmware version of up to all four modules that are available on the UTx platform. This list also displays the date and time for convenience.

<b>FIRMWARE</b>	←	'Firmware' serves as a label only
TM : v5.14	←	Transmitter (UTx) firmware version
DM : v5.14	←	Display module firmware version
SM1 : v5.14	←	First sensor module version, if applicable
SM2 : v5.13	←	Second sensor module version, if applicable
YYYY-MM-DD HH:MM:SS	←	Date and time information

### 4.3.7 Quick Info Screen

To access the quick info screen, simultaneously press the UP and DOWN buttons from the main screen, until the following screen appears.

The quick info screen provides the bus voltage supplied to unit (V), RTC battery voltage (V), temperature (°C and °F), pressure (Pa), and relative humidity (%RH), or "N/A" if not available.

<b>QUICK INFO</b>	←	'QUICK INFO' serves as a label only
BUS/BAT: 24.3/2.9 V	←	Bus voltage / RTC battery voltage
T: 23 (C) / 73 (F)	←	Temperature
P: 99105 (Pa)	←	Pressure
%RH: 33	←	Relative humidity

The user can exit the quick info screen by pressing the ENTER button to return to the main info screen.

### 4.3.8 Password Entry

To access the service menu system, the user needs to press and hold the **ENTER** button until the following password entry screen is displayed.

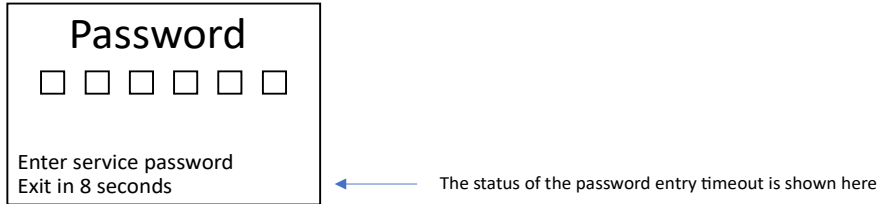

Enter the password using a combination of the **UP**, **DOWN** and **ENTER** buttons. The password is factory set to **UP - DOWN - UP - DOWN - ENTER - ENTER**. As the password is being entered, the display updates with each button press. The diagram below illustrates the state of the password entry after 3 button presses. The password entry screen will timeout after 10 seconds if no button is pressed thereby returning the user back to the main info screen.

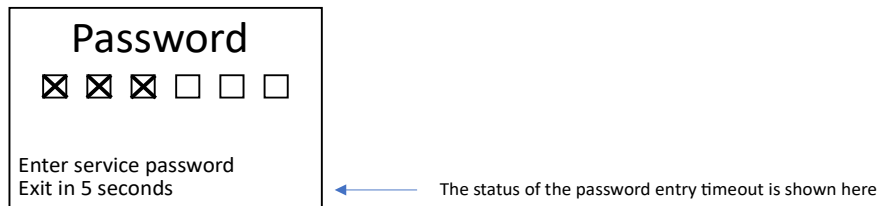

### 4.3.9 Main Service Menu

#### 4.3.9.1 Service Menu Timeout

The service menus remain unlocked for a programmed timeout period (set to 5 minutes). Within that period, the service menus can be re-enabled by long pressing the **ENTER** button. If the timeout period is allowed to expire, the password entry screen will appear prior to accessing the service menus. Also, if the service menu is active when a timeout occurs, the service mode is disabled, and the display will go blank (i.e. power saving mode). Lastly, the service menu timeout is reset with each button press while the service menus are active.

#### 4.3.9.2 Service Menu Overview

Once the correct password is entered, the main service menu is displayed as shown in the following diagram.

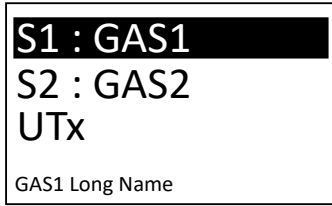

Highlighted background indicates which service menu is selected

The name of the selected service menu. In the case of a sensor service menu, the sensor's gas serves as its name

Once again, the **UP** and **DOWN** buttons can be used to navigate the list of service menus. The main service menu provides the menu items listed in the table below:

**Table 4-7: Service Menu Options**

Menu Item	Description
<Sensor #>: <Gas Label>	Each sensor is included in the service menu indicated by its number and gas label (Ex: S2: CO).
UTx	Access the settings for the transmitter module through the 'UTx' menu item.
Exit	Select this menu item to exit the service menu.

To exit the Service Menu, press **DOWN** repeatedly until the end is reached and Exit is highlighted as shown below.

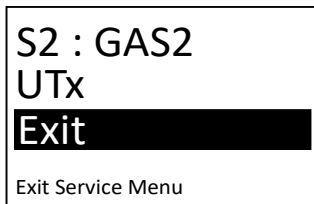

Highlighted background indicates that Exit is selected

Context sensitive help

With 'Exit' highlighted (as above), press **ENTER** to exit the service mode and return back to the main info screen as shown below.

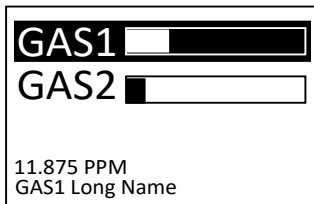

Upon exiting the service menus, the first sensor is selected by default

Details for the current sensor are updated in real-time as well as the progress bar which represents the current value relative to its max value

### 4.3.10 External Sensor Service Menu

**NOTE:** The Outputs menu (available from the main service menu) is used to provide supplemental configuration options that are applicable to external sensors, beyond those in the External Sensor Service menu.

#### 4.3.10.1 External Sensor Service Menu Overview

If the **ENTER** button is pressed while the service menus are active and an external sensor is currently selected, then the following menu is shown for external sensors. This menu is common to all external sensors, therefore, selecting any external sensor will produce the same menu.

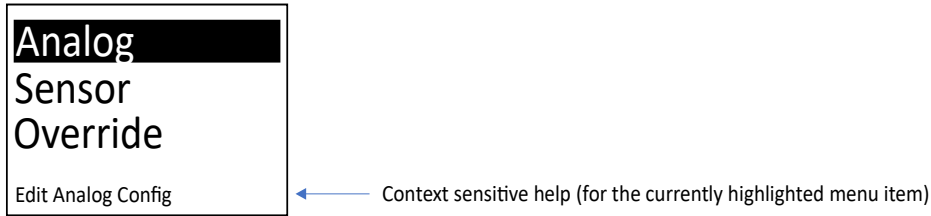

The **UP** and **DOWN** buttons can be used to navigate the list of service menus for the selected sensor. The sensor's service menu provides the following menu items:

**Table 4-8: External Sensor Menu Options**

Menu Item	Description
Analog	Analog configuration sub-menu for the selected sensor.
Sensor	Sensor configuration sub-menu for the selected sensor.
Override	Override sub-menu for the selected sensor.
Exit	Select this menu to return to the main service menu.

#### 4.3.10.2 Analog Sub-Menu

If 'Analog' configuration sub-menu is activated from the sensor's service menu when an external sensor is selected, then the display will be updated to show the following sub-menu.

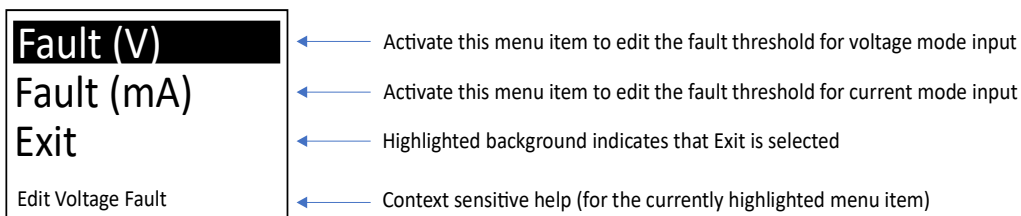

The **UP** and **DOWN** buttons can be used to navigate the list of analog configuration options for the selected external sensor. The analog configuration sub-menu is defined in the below table:

**Table 4-9: Analog Sub-Menu Options**

Menu Item	Description
Fault (V)	Activate this menu item to edit the fault threshold (in V) for voltage mode input.
Fault (mA)	Activate this menu item to edit the fault threshold (in mA) for current mode input.

Exit	Select this menu item to return to the sensor’s service menu. The ‘Analog’ sub-menu will be selected when the sensor’s service menu appears.
------	--

If ‘Fault (V)’ is activated from the ‘Analog’ configuration sub-menu, then the display will be updated to show the following editing screen.

**Fault (V)**

**01.0**

Enter To Adv Cursor

- ← ‘Fault (V)’ serves as a label only.
- ← Edit the voltage fault threshold value one digit at a time using the UP/DOWN buttons. Press ENTER to advance the cursor to the next digit. Press ENTER when the last digit is highlighted to save the value.
- ← Context sensitive help (for the currently highlighted menu item)

When the **ENTER** button is pressed with the last digit selected, the screen will update to display the confirmation dialog (described previously). If ‘Yes’ is selected, the edit value is persisted as the new value for the voltage fault threshold for the selected external sensor. Otherwise, the edit value is rejected. In either case, the menu returns to the ‘Analog’ configuration sub-menu menu with the ‘Fault (V)’ menu item selected.

**NOTE:** This value only applies when the input mode is voltage mode and has a non-zero minimum input. For example, with an external sensor configured for operation between 2 - 10 V, setting a fault value of 1 V would lead to the sensor being found in a ‘FAIL’ state with an input voltage of less than 1 V.

**CAUTION:** Entering a fault value of 0 V disables the fault check.

If ‘Fault (mA)’ is activated from the ‘Analog’ configuration sub-menu, then the display will be updated to show the following editing screen.

**Fault (mA)**

**02.5**

Enter To Adv Cursor

- ← ‘Fault (mA)’ serves as a label only.
- ← Edit the current fault threshold value one digit at a time using the UP/DOWN buttons. Press ENTER to advance the cursor to the next digit. Press ENTER when the last digit is highlighted to save the value.
- ← Context sensitive help (for the currently highlighted menu item)

When the **ENTER** button is pressed with the last digit selected, the screen will update to display the confirmation dialog (described previously). If Yes is selected, the edit value is persisted as the new value for the current fault threshold for the selected external sensor. Otherwise, the edit value is rejected. In either case, the menu returns to the ‘Analog’ configuration sub-menu menu with the ‘Fault (mA)’ menu item selected.

**NOTE:** This value only applies when the input mode is current mode and has a non-zero minimum input. For example, with an external sensor configured for operation between 4 - 20 mA, setting a fault value of 2 mA would lead to the sensor being found in a 'FAIL' state with an input current of less than 2 mA.

**CAUTION:** Entering a fault value of 0 mA disables the fault check.

If 'Exit' is activated from the 'Analog' configuration sub-menu, then the user is returned to the sensor's service menu for an external sensor.

#### 4.3.10.3 Sensor Sub-Menu

If the 'Sensor' sub-menu is activated from the sensor's service menu when an external sensor is selected, then the display will be updated to show the following sub-menu.

The **UP** and **DOWN** buttons can be used to navigate the list of sensor configuration options for the selected external sensor. The sensor configuration sub-menu is defined in the below table:

**Table 4-10: Sensor Sub-Menu Options**

Menu Item	Description
Gas Label	Activate this menu item to edit the gas label for the selected sensor.
Eng Units	Activate this menu item to edit the engineering units for the selected sensor.
Exit	Select this menu item to return to the sensor's service menu. The 'Config' sub-menu will be selected when the sensor's service menu appears.

#### 4.3.10.4 Gas Label

If 'Gas Label' is activated from the 'Sensor' sub-menu, then the display will be updated to show the following editing screen.

Each character can be edited to any alpha-numeric value (A-Z, 0-9) including a space. When **ENTER** button is pressed with the last non-space character highlighted, a space will be appended to the label to allow expanding the label value.

When the **ENTER** button is pressed with the last character selected and that character is a space, the screen will update to display the confirmation dialog (described previously). If 'Yes' is selected, the edit value is persisted as the new value for the Gas Label for the selected external sensor. Otherwise, the edit value is rejected. In either case, the menu returns to the 'Sensor' configuration sub-menu menu with the 'Gas Label' menu item selected.

#### 4.3.10.5 Engineering Units

If 'ENG UNITS' is activated from the 'Sensor' sub-menu, then the display will be updated to show the following editing screen.

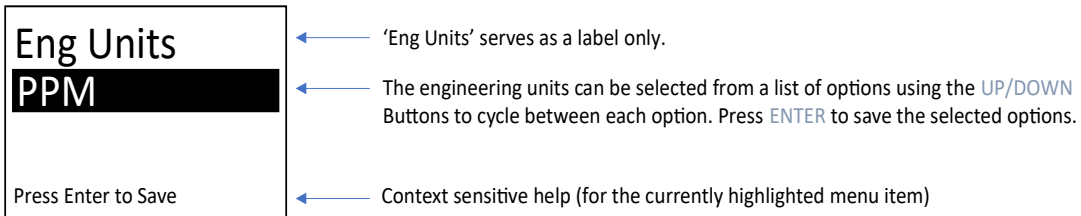

The available options for 'ENG UNITS' are listed in the following table.

**Table 4-11: Engineering Unit Options**

Menu Item	Description
PPB	Parts per Billion
PPM	Parts per Million
% LEL	Percent of Lower Explosive Limit
% VOL	Percent by Volume
Volt	Voltage
% FS	Percent of Full Scale
% LFL	Percent of Lower Flammable Limit

When the **ENTER** button is pressed, the screen will update to display the confirmation dialog (described previously).

#### 4.3.10.6 Simulation Of Gas Levels (External Sensors)

The External Sensor Menu allows the current gas reading of an external sensor to be overridden by a simulated gas level. This may be useful during the system commissioning to verify operation of the Monitor or alarm relays.

**Table 4-12: External Override Sub-Menu Options**

Menu Item	Description
-----------	-------------

Sim Enable	Menu item for turning the external gas override value on/off.
Sim Gas	Allows an external override value to be selected (only applied if Sim Enable set to “Enabled”).
Exit	Select this menu item to return to the external sensor service menu.

#### 4.3.10.7 Override

If ‘Override’ sub-menu is activated from the external sensor’s service menu, then the display will be updated to show the following sub-menu.

- ← Activate this menu item to edit the simulated gas enable flag for the selected sensor
- ← Activate this menu item to edit the simulated gas concentration for the selected sensor
- ← Activate this menu item to exit the “Override” sub-menu
- ← Context sensitive help (for the currently highlighted menu item)

#### 4.3.10.8 Sim Enable

If ‘Sim Enable’ is activated from the ‘Override’ sub-menu, then the display will be updated to show the following editing screen.

- ← Defaults to the current value of the Sim Enable flag. Use UP/DOWN arrow buttons to toggle between Disabled and Enabled. Press ENTER button to confirm selection.
- ← Context sensitive help (for the currently highlighted menu item)

When the **ENTER** button is pressed, the confirmation screen (described previously) is displayed. If ‘Yes’ is selected, the edit value is persisted as the new value for the Sim Enable flag. Otherwise, the edit value is rejected. In either case, the menu returns to the Override sub-menu menu with the ‘Sim Enable’ menu item selected.

#### 4.3.10.9 Sim Gas

If ‘Sim Gas’ is activated from the ‘Override’ sub-menu, then the display will be updated to show the following editing screen.

- ← ‘Sim Gas’ serves as a label only.
- ← Edit the simulated gas value one digit at a time using the UP/DOWN buttons. Press ENTER to advance the cursor to the next digit. Press ENTER when the last digit is highlighted to save the value.
- ← Context sensitive help

When the **ENTER** button is pressed with the last digit highlighted, the confirmation screen (described previously) is displayed. If ‘Yes’ is selected, the edit value is persisted as the new value for the Sim

Gas concentration value. Otherwise, the edit value is rejected. In either case, the menu returns to the Override sub-menu menu with the ‘Sim Gas’ menu item selected.

Selected ‘Exit’ from the ‘Override’ sub-menu returns the user to the sensor’s service menu with the ‘Override’ menu item selected.

### 4.3.11 Transmitter Service Menu

If the ‘UTx’ menu item is activated from the main service menu via the **ENTER** button, then the UTx service menu will appear on the display as shown in the following diagram.

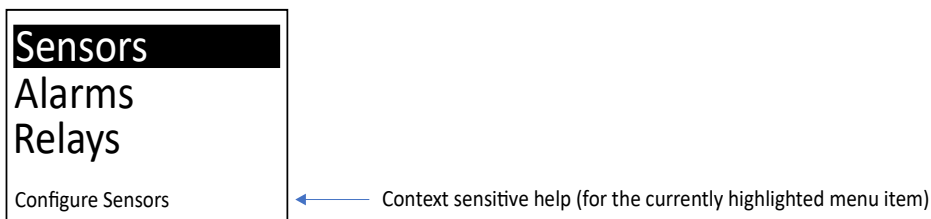

The **UP** and **DOWN** buttons can be used to navigate the list of service menus for the UTx. The following table outlines all the menu items from the UTx menu:

**Table 4-13: Transmitter Service Menu Options**

Options	
Menu Item	Description
Sensors	Select this menu item to activate the Sensors sub-menu.
Alarms	Select this menu item to activate the Alarms sub-menu.
Relays	Select this menu item to activate the Relays sub-menu.
Outputs	Select this menu item to activate the Outputs sub-menu.
Test	Select this menu item to toggle the test enable flag.
Buzzer	Select this menu item to toggle the low alarm buzzer enable flag.
Ack Timer	Select this menu item to adjust the buzzer acknowledgement timeout (30 – 120 seconds).
Date	Select this menu item to adjust the real-time clock (RTC) year, month, and day.
Time	Select this menu item to adjust the real-time clock (RTC) hour and minute.
Reset	Select this menu item to trigger a software reset of the UTx.
Exit	Select this menu item to return to the main service menu. The menu item for the UTx will be selected when the main service menu appears.

#### 4.3.11.1 Transmitter Sensors Settings

From the UTx service menu, selecting ‘Sensors’ will update the display to show the following sub-menu.

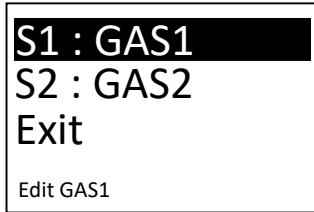

← Context sensitive help (for the currently highlighted menu item)

The **UP** and **DOWN** buttons can be used to navigate the list of configured sensors for the sensors sub-menu. The table below outlines all the menu items from the sensors sub-menu:

**Table 4-14: Sensor Module Configuration Menu**

Menu Item	Description
S1: GAS1	Select this menu item to activate the configuration sub-menu for sensor 1.
S2: GAS2	Select this menu item to activate the configuration sub-menu for sensor 2.
Exit	Select this menu item to return to the UTx service menu.

#### 4.3.11.2 Sensor Alarm Configuration Sub-Menu

Selecting a sensor from the ‘Sensors’ sub-menu (ex: S1: GAS1) will update the display to show the following sub-menu.

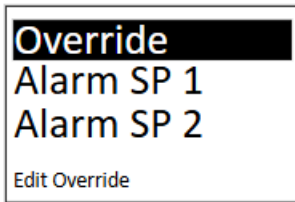

← Context sensitive help (for the currently highlighted menu item)

The **UP** and **DOWN** buttons can be used to navigate the list of menus for the ‘Sensors’ sub-menu. The below table outlines all the menu items from the sensor sub-menu:

**Table 4-15: Sensor Alarm Configuration**

Menu Item	Description
Override	Override sub-menu item for the selected sensor.
Alarm SP 1-3	Select this menu item to edit the alarm setpoints for the selected alarm (1-3).
Alarm Hyst	Select this menu item to edit the alarm hysteresis. This hysteresis value is applied to all alarm setpoints.

Zero Buff	Select this menu item to edit the zero-buffer level for the display of small gas concentrations.
Cal Freq	Select this menu item to edit the time period between re-calibrations.
Exit	Select this menu item to return to the Sensors sub-menu.

#### 4.3.11.2.1 Override

The override menu item allows the current gas reading to be overridden by a simulated gas level. This may be useful during system configuration to verify operation of the Digital Monitor or alarm relays.

**NOTE:** An override menu item may be found in the Sensor Service menus. It's usage is identical. Should the user activate the override through both menus at the same time, the override value entered through this Sensor Alarm Configuration sub-menu will take precedence.

If 'Override' is activated from the Sensor Alarm Configuration sub-menu, then the display will be updated to show the following sub-menu:

The screenshot shows a menu with the following items: Sim Enable, Sim Gas, Exit, and Edit Sim Enable. Annotations point to each item:

- ← Sim Enable: Activate this menu item to edit the simulated gas enable flag for the selected sensor
- ← Sim Gas: Activate this menu item to edit the simulated gas concentration for the selected sensor
- ← Exit: Activate this menu item to exit the 'Override' sub-menu
- ← Edit Sim Enable: Context sensitive help (for the currently highlighted menu item)

If 'Sim Enable' is activated from the 'Override' sub-menu, then the display will be updated to show the following editing screen.

The screenshot shows the 'Sim Enable' screen with 'Disabled' selected. Annotations point to the screen elements:

- ← Disabled: Defaults to the current value of the Sim Enable flag. Use UP/DOWN arrow buttons to toggle between Disabled and Enabled. Press ENTER button to confirm selection.
- ← Press Enter to Save: Context sensitive help

When the **ENTER** button is pressed, the confirmation screen (described previously) is displayed. If 'Yes' is selected, the edit value is persisted as the new value for the Sim Enable Flag. Otherwise, the edit value is rejected. In either case, the menu returns to the Override sub-menu menu with 'Sim Enable' menu is selected.

The screenshot shows the 'Override' sub-menu with 'Sim Gas' highlighted. Annotations point to each item:

- ← Sim Enable: Activate this menu item to edit the simulated gas enable flag for the selected sensor
- ← Sim Gas: Activate this menu item to edit the simulated gas concentration for the selected sensor
- ← Exit: Activate this menu item to exit the 'Override' sub-menu
- ← Edit Sim Gas Enabled: Context sensitive help (for the currently highlighted menu item)

If 'Sim Gas' is activated from the 'Override' sub-menu, then the display will be updated to show the following editing screen.

'Sim Gas' serves as a label only, therefore, this item can not be selected.

Edit the simulated gas value one digit at a time using the UP/DOWN buttons. Press ENTER to advance the cursor to the next digit. Press ENTER when the last digit is highlighted to save the value.

Context sensitive help

When the **ENTER** button is pressed with the last digit highlighted, the confirmation screen (described previously) is displayed. If 'Yes' is selected, the edit value is persisted as the new value for the Sim Gas concentration value. Otherwise, the edit value is rejected. In either case, the menu returns to the Override sub-menu menu with the 'Sim Gas' menu item selected.

Selected 'Exit' from the 'Override' sub-menu returns the user to the Sensor Alarm Configuration sub-menu with the 'Override' menu item selected.

#### 4.3.11.2.2 Setpoint

If 'Alarm SP 1' is activated from the sensor alarm configuration sub-menu, then the display will be updated to show the following editing screen.

'Alarm SP 1' serves as a label only.

Edit the alarm 1 setpoint value one digit at a time using the UP/DOWN buttons. Press ENTER to advance the cursor to the next digit. Press ENTER when the last digit is highlighted to save the value.

Context sensitive help

When the **ENTER** button is pressed, the screen will update to display the confirmation dialog (described previously).

The same process is repeated for Alarm SP 2 and Alarm SP 3. In all cases, once the confirmation dialog is reached, regardless of which option it selected, the user is returned back to the Sensors sub-menu.

#### 4.3.11.2.3 Alarm Hysteresis

If 'Alarm Hyst' is activated from the sensor sub-menu, then the display will be updated to show the following editing screen.

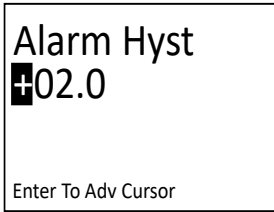

- ← 'Alarm Hyst' serves as a label only.
- ← Edit the alarm hysteresis setpoint value one digit at a time using the UP/DOWN buttons. Press ENTER to advance the cursor to the next digit. Press ENTER when the last digit is highlighted to save the value.
- ← Context sensitive help

When the **ENTER** button is pressed, the screen will update to display the confirmation dialog (described previously). If 'Yes' is selected, the edit value is persisted as the new value for the Alarm Hysteresis for the selected sensor. Otherwise, the edit value is rejected. In either case, the menu returns to the Sensor sub-menu menu with the 'Alarm Hyst' menu item selected.

#### 4.3.11.2.4 Zero Buffer

If 'Zero Buff' is activated from the sensor sub-menu, then the display will be updated to show the following editing screen.



- ← 'Zero Buff' serves as a label only.
- ← Edit the alarm hysteresis setpoint value one digit at a time using the UP/DOWN buttons. Press ENTER to advance the cursor to the next digit. Press ENTER when the last digit is highlighted to save the value.
- ← Context sensitive help

When the **ENTER** button is pressed, the screen will update to display the confirmation dialog (described previously). If 'Yes' is selected, the edit value is persisted as the new value for the Zero Buffer for the selected sensor. Otherwise, the edit value is rejected. In either case, the menu returns to the Sensor sub-menu menu with the 'Zero Buff' menu item selected.

#### 4.3.11.2.5 Calibration Frequency

If 'Cal Freq' is activated from the sensor sub-menu, then the display will be updated to show the following editing screen.



- ← 'Cal Freq' serves as a label only.
- ← The calibration frequency can be selected from a list of options using the UP/DOWN buttons to cycle between each option. Press ENTER to save the selected options.
- ← Context sensitive help

The available options for 'Cal Freq' are listed in the table below.

**Table 4-16: Calibration Frequency Configuration**

Menu Item	Description
OFF	Next calibration due date is not calculated.

3 Months	Next calibration due date is calculated as 3 months from last calibration timestamp.
4 Months	Next calibration due date is calculated as 4 months from last calibration timestamp.
6 Months	Next calibration due date is calculated as 6 months from last calibration timestamp.
12 Months	Next calibration due date is calculated as 12 months from last calibration timestamp.

When the **ENTER** button is pressed, the screen will update to display the confirmation dialog (described previously).

#### 4.3.11.3 Transmitter Alarms Settings

From the UTx service menu, selecting 'Alarms' will update the display to show the following sub-menu.

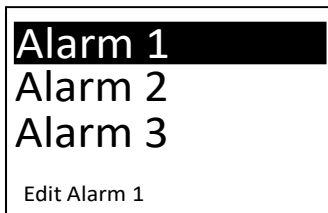

← Context sensitive help (for the currently highlighted menu item)

The **UP** and **DOWN** buttons can be used to navigate the list of menus for the Alarms sub-menu. The table below outlines all the menu items from the Alarms sub-menu:

**Table 4-17: Transmitter Alarm Settings**

Menu Item	Description
Alarm 1-18	Select this menu item to activate the configuration sub-menu for the selected alarm.
Exit	Select this menu item to return to the UTx service menu. The alarms menu item will be selected when the UTx service menu appears.

#### 4.3.11.4 Alarm Sub-Menu

Selecting an alarm from the alarms sub-menu will update the display to show the following:

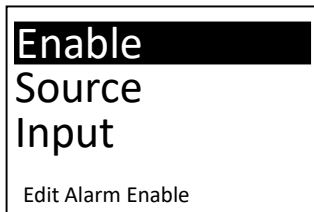

← Context sensitive help (for the currently highlighted menu item)

The below table outlines all the menu items from the alarm sub-menu:

**Table 4-18: Transmitter Alarm Sub-Menu Settings**

Menu Item	Description
Enable	Select this menu item to edit the alarm's enable state.
Source	Select this menu item to edit the alarm's source (i.e. from the available sensors).
Input	Select this menu item to edit the alarm's input value.
Level	Select this menu item to edit the alarm's setpoint.
Type	Select this menu item to edit the alarm's type (increasing or decreasing).
Output	Select this menu item to edit the alarm's trigger output (i.e. activate which relays).
Act Delay	Select this menu item to edit the alarm's act delay in terms of seconds.
Min Run	Select this menu item to edit the alarm's minimum run time in terms of seconds.
Exit	Select this menu item to return to the Alarms sub-menu.

**4.3.11.4.1 Enable**

If 'Enable' is activated from the alarm sub-menu, then the display will be updated to show the following editing screen.

'Enable' serves as a label only.

Defaults to the current value of the Enable flag. Use UP/DOWN arrow buttons to toggle between Disabled and Enabled. Press ENTER button to confirm selection.

Context sensitive help

When the **ENTER** button is pressed, the confirmation screen (described previously) is displayed.

**4.3.11.4.2 Source**

If 'Source' is activated from the alarm sub-menu, then the display will be updated to show the following editing screen.

'Source' serves as a label only.

The source can be selected from a list of sensors. Cycle through all the values using the UP/DOWN buttons.

Context sensitive help

The available options for ‘Source’ are equal to the list of sensors currently configured for the UTx. The label for each sensor is dynamically assigned to S<n>: GAS<n> where n represents the sensor’s 1 base index and GAS represents the sensor’s gas name in short form.

When the **ENTER** button is pressed, the screen will update to display the confirmation dialog (described previously).

#### 4.3.11.4.3 Input

If ‘Input’ is activated from the alarm sub-menu, then the display will be updated to show the following editing screen.

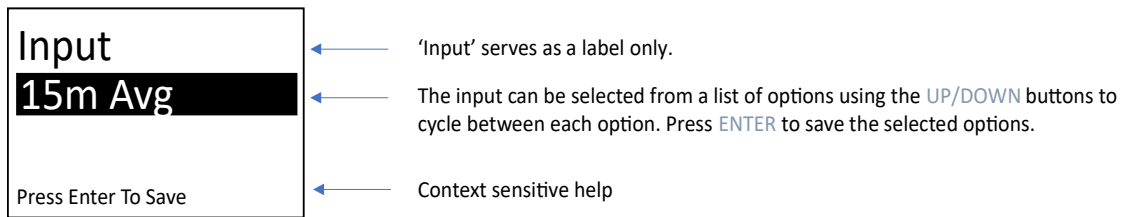

The available options for ‘Input’ are listed in the table below:

**Table 4-19: Alarm Input Options**

Menu Item	Description
Inst. Value	Instantaneous gas value, updated once per second.
15m Avg	Gas concentration averaged over the past 15 minutes.
8h Avg	Gas concentration averaged over the past 8 hours.
Daily Peak	Daily peak value.

When the **ENTER** button is pressed, the screen will update to display the confirmation dialog (described previously).

#### 4.3.11.4.4 Level

If ‘Level’ is activated from the alarm sub-menu, then the display will be updated to show the following editing screen.

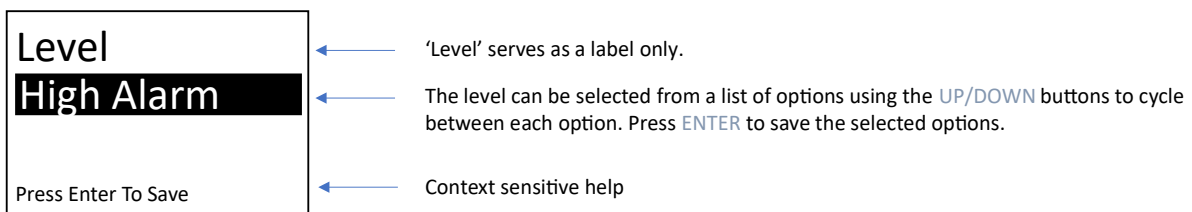

The available options for ‘Level’ are listed the below table.

**Table 4-20: Alarm Setpoint Options**

Menu Item	Description
Warning	Alarm setpoint 1 from the selected source.

Alarm	Alarm setpoint 2 from the selected source.
High Alarm	Alarm setpoint 3 from the selected source.

When the **ENTER** button is pressed, the screen will update to display the confirmation dialog (described previously).

#### 4.3.11.4.5 Type

If 'Type' is activated from the alarm sub-menu, then the display will be updated to show the following editing screen.

← 'Type' serves as a label only.

← The type can be selected from a list of options using the **UP/DOWN** buttons to cycle between each option. Press **ENTER** to save the selected options.

← Context sensitive help

The available options for 'Type' are listed in the table below:

**Table 4-21: Alarm Type Options**

Menu Item	Description
Increasing	Alarm is triggered when alarm exceeds its threshold in an increasing direction.
Decreasing	Alarm is triggered when alarm exceeds its threshold in a decreasing direction.

When the **ENTER** button is pressed, the screen will update to display the confirmation dialog (described previously).

#### 4.3.11.4.6 Output

If 'Output' is activated from the alarm sub-menu, then the display will be updated to show the following editing screen.

← Use the **UP/DOWN** buttons to cycle between each relay. Press **ENTER** to toggle between checked or unchecked.

← Context sensitive help

The available options for 'Output' are 'Local' and 'Relay 1' through 'Relay 5' (depending on variant). If the checkbox next to the relay is checked, then that relay will activate when the associated alarm is active. Otherwise, the relay will not activate.

When the **ENTER** button is pressed with 'Done' selected, the screen will update to Transmitter Alarm Sub-Menu.

#### 4.3.11.4.7 Act Delay

If 'Act Delay' is activated from the Alarm sub-menu, then the display will be updated to show the following editing screen.

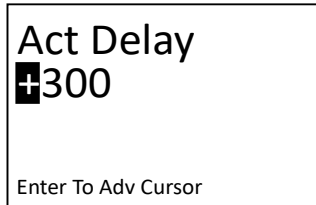

- ← 'Act Delay' serves as a label only.
- ← Edit the act delay value one digit at a time using the **UP/DOWN** buttons. Press **ENTER** to advance the cursor to the next digit. Press **ENTER** when the last digit is highlighted to save the value.
- ← Context sensitive help

When the **ENTER** button is pressed while the last digit is highlighted, the screen will update to display the confirmation dialog (described previously).

#### 4.3.11.4.8 Min Run

If 'Min Run' is activated from the Alarm sub-menu, then the display will be updated to show the following editing screen.



- ← Edit the minimum run time value one digit at a time using the **UP/DOWN** buttons. Press **ENTER** to advance the cursor to the next digit. Press **ENTER** when the last digit is highlighted to save the value.
- ← Context sensitive help

When the **ENTER** button is pressed while the last digit is highlighted, the screen will update to display the confirmation dialog (described previously).

#### 4.3.11.5 Transmitter Relay Settings

From the UTx service menu, selecting 'Relays' will update the display to show the following sub-menu.

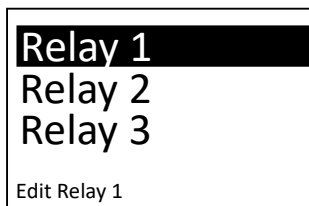

- ← Context sensitive help

The **UP** and **DOWN** buttons can be used to navigate the list of menus for the Alarms sub-menu. The table below outlines all the menu items from the Alarms sub-menu:

**Table 4-22: Relay Menu**

Menu Item	Description
Relay 1-5	Selecting this menu item to activate the configuration sub-menu for the selected relay (ranging from 1 to 5).
Exit	Select this menu item to return to the UTx service menu. The Relays menu item will be selected when the UTx service menu appears.

Selecting a relay from the alarms sub-menu will update the display to show the following:



← Context sensitive help (for the currently highlighted menu item)

The table below outlines all the menu items from the relay sub-menu:

**Table 4-23: Relay Sub-Menu**

Menu Item	Description
Polarity	Select this menu item to edit the relay's polarity setting.
Exit	Select this menu item to return to the Relays sub-menu.

If 'Polarity' is activated from the relay sub-menu, then the display will be updated to show the following editing screen.

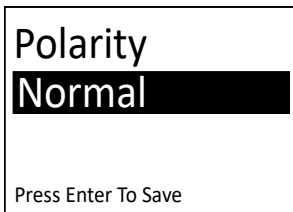

← 'Polarity' serves as a label only.

← The polarity can be selected from a list of options using the **UP/DOWN** buttons to cycle between each option. Press **ENTER** to save the selected options.

← Context sensitive help

The available options for ‘Polarity’ are listed in the table below:

**Table 4-24: Relay Polarity Menu**

Menu Item	Description
Normal	Relay coil is energized when associated alarm is active. Otherwise, the relay coil is de-energized.
Reverse	Relay coil is de-energized when associated alarm is active. Otherwise, the relay coil is energized.

When the **ENTER** button is pressed, the screen will update to display the confirmation dialog (described previously).

**NOTE:** The monitor system configuration is factory-set to use the reverse setting for the fail-safe mode. Fail safe mode provides continuity between COM to NC during WARN/ALARM/FAULT and power failure, and the associated relay LED indicator will be off.

#### 4.3.11.6 Outputs

Analog output configuration is handled via the Outputs menu available from the main service menu. With the Outputs menu it is possible to configure the analog output to use multiplexed sensor sources to determine the output response; this section concludes with an example. Once in the Outputs menu, the **UP** and **DOWN** buttons can be used to navigate the list of available analog outputs to be configured.

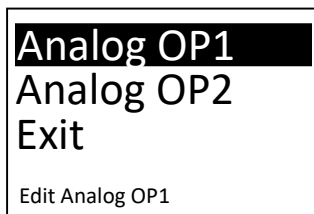

← Context sensitive help (for the currently highlighted menu item)

**Table 4-25: Outputs Sub-Menu**

Menu Item	Description
Source	Allows the analog output channel to be driven based on desired gas sources. With this menu item, it is possible to multiplex several of the available gases together to drive the output.
Mode	Used to select between voltage or current analog output modes.
Range	Can be used to adjust the output range. The units in the menu are either V or mA, depending on the selection chosen with the Mode menu item.

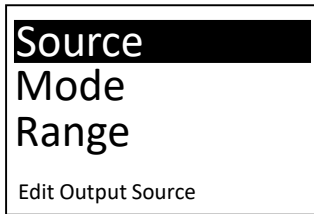

← Context sensitive help (for the currently highlighted menu item)

#### 4.3.11.6.1 Source

When the **ENTER** button is pressed with Source selected, the list of available gases will be presented. A checkbox to the left of each gas label indicates if a gas is being used in the calculation of the analog output.

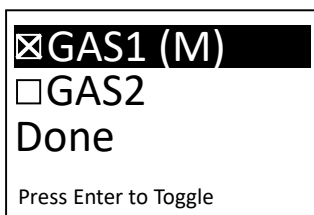

← Context sensitive help (for the currently highlighted menu item)

To the right of each enabled gas an “M” or “A” in brackets denotes which gas concentration is used in scaling the output response. The “M” indicates that the maximum supported gas concentration of the sensor is used in scaling the output response. An “A” indicates that the gas concentration tied to the high alarm (Alarm SP 3, see the **‘Transmitter Sensor Settings’** section, is used as max scale in the calculation of the analog output response.

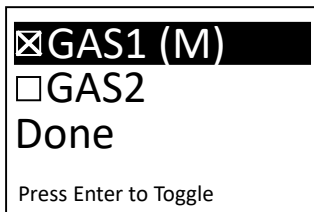

← Context sensitive help (for the currently highlighted menu item)

When the **ENTER** button is pressed with an unchecked gas selected, a screen will be presented to allow the selection between the max gas concentration (“MAX”) or Alarm SP 3 (“HI ALARM”). Use the **UP** and **DOWN** buttons to select between the two options, and press **ENTER** to confirm the selection. This will cause a return to Source sub-menu with the gas as checked. Pressing the **ENTER** button on an already checked gas will cause it to become unchecked and clear the “M” or “A” setting.

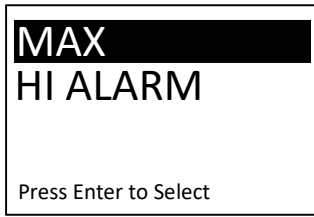

- ← Press **UP/DOWN** to toggle between options.
- ← Context sensitive help (for the currently highlighted menu item)

#### 4.3.11.6.2 Mode

From the Outputs menu, when the **ENTER** button is pressed with Mode selected, a menu option to select between and analog output mode of voltage or current will be presented. Use the UP and **DOWN** buttons to select between the two options, and press **ENTER** to confirm the selected mode.

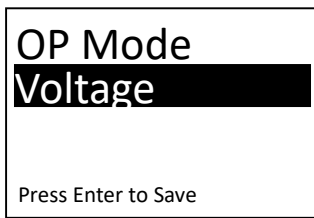

- ← Press **UP/DOWN** to toggle between voltage and current output modes.
- ← Context sensitive help (for the currently highlighted menu item)

#### 4.3.11.6.3 Range

From the Outputs menu, when the **ENTER** button is pressed with Range selected, a sub-menu to configure the minimum and maximum analog output response will become available. The engineering unit (V or mA) displayed in the Output Min/Max menu items will reflect the analog output mode selected with the Mode menu item.



- ← Context sensitive help (for the currently highlighted menu item)

The permitted analog output range for voltage mode is between 0-10V.

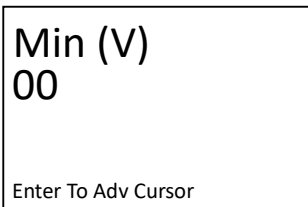

- ← 'Min (V)' serves as a label only.
- ← Edit the window filter value one digit at a time using the **UP/DOWN** buttons. Press **ENTER** to advance the cursor to the next digit. Press **ENTER** when the last digit is highlighted to save the value.
- ← Context sensitive help

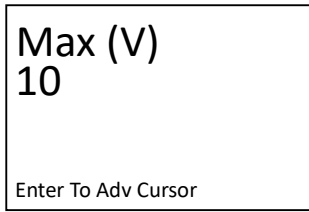

- ← 'Max (V)' serves as a label only.
- ← Edit the window filter value one digit at a time using the UP/DOWN buttons. Press ENTER to advance the cursor to the next digit. Press ENTER when the last digit is highlighted to save the value.
- ← Context sensitive help

The permitted analog output range for current mode is between 0-20mA.

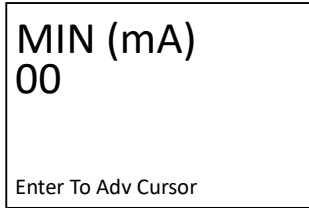

- ← 'MIN (mA)' serves as a label only.
- ← Edit the window filter value one digit at a time using the UP/DOWN buttons. Press ENTER to advance the cursor to the next digit. Press ENTER when the last digit is highlighted to save the value.
- ← Context sensitive help

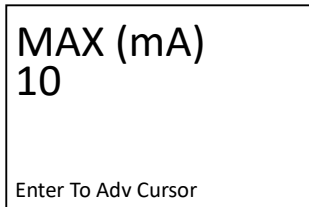

- ← 'MAX (mA)' serves as a label only.
- ← Edit the window filter value one digit at a time using the UP/DOWN buttons. Press ENTER to advance the cursor to the next digit. Press ENTER when the last digit is highlighted to save the value.
- ← Context sensitive help

#### 4.3.11.6.4 Multiplexing Example

With an overview of the Outputs menu complete, it is worthwhile to show an example of how a multiplexed sensor configuration can be used to drive the analog output. In this example, the following configuration is used:

- Voltage output mode on OP1.
- 2-10V range selected for OP1.
- GAS1, with a max gas concentration of 100 PPM, and Alarm SP 3 of 100 PPM.
- GAS2, with a max gas concentration of 10 PPM, and Alarm SP 3 of 3 PPM.
- GAS1 and GAS2 are to be multiplexed; whichever gas has a higher percentage of maximum scale is to drive the output.
- GAS1 is using the max gas concentration for scaling (“M”), whereas GAS2 is using Alarm SP 3 (“A”).

Suppose GAS1 has a present reading of 7 PPM, and GAS2 has a present reading of 0.5 PPM. GAS1 has a percent of max scale of  $7/100=0.07$ . GAS2 has a percent of max scale of  $0.5/3=0.16$ . As a result, it is GAS2 that presently determines the analog output response.

The range selected for voltage mode is  $(10V - 2V) = 8V$ . Accounting for the output offset (Output Min) of 2V, the analog output value will be found to be  $2V + 0.16 * 8V = 3.33 V$ .

#### 4.3.11.7 Buzzer

From the UTx service menu, selecting 'Buzzer' will update the display to show the following:

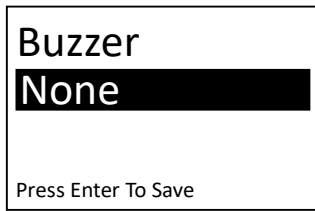

- ← 'Buzzer' serves as a label only.
- ← The buzzer activation level can be selected from a list of options using the UP/DOWN buttons to cycle between each option. Press ENTER to save the selected options.
- ← Context sensitive help

The available options for 'Buzzer' are listed in the table below:

**Table 4-26: Buzzer Menu**

Menu Item	Description
None	Disable local buzzer completely.
Alarm	Local buzzer sounds for alarm level and fault.
All Levels	Local buzzer sounds for warning, alarm, high alarm levels, and fault.

#### 4.3.11.8 Acknowledgement Timer

From the UTx service menu, selecting 'Ack Timer' will update the display to show the following:

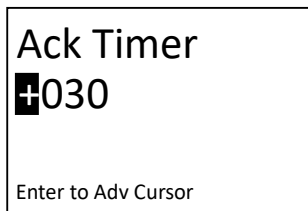

- ← 'Ack Timer' serves as a label only.
- ← Edit the activation timer value one digit at a time using the UP/DOWN buttons. Press ENTER to advance the cursor to the next digit. Press ENTER when the last digit is highlighted to save the value.
- ← Context sensitive help

When the **ENTER** button is pressed while the last digit is highlighted, the screen will update to display the confirmation dialog (described previously).

The allowable values for the activation timer are 30-120 seconds. During an alarm state, the local buzzer may be silenced for a period equal to activation timer, by pressing the **ENTER** button.

#### 4.3.11.9 RTC Date & Time

The main service menu Date and Time items can be used to update the on-board real-time clock (RTC). The RTC runs on battery power when main power is unavailable. These menus provide a mechanism to update the date and time, for example, in the event of low battery during a power outage.

Use the **UP** and **DOWN** buttons to scroll through available year, month, and day options. A short press of the **ENTER** button will advance to the next digit. A long press of the **ENTER** button will return to the previous digit. Press the **ENTER** button on the last digit to proceed to the confirmation Save dialog.

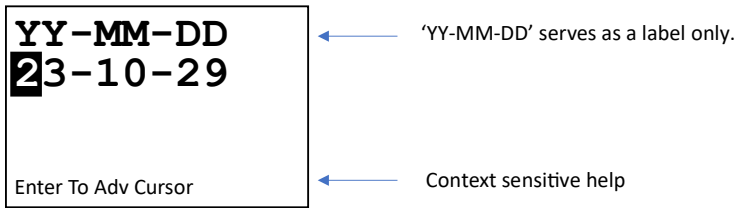

Button presses for Time menu behave in the same manner as the Date menu. Note that it is only possible to update the RTC hour and minute currently.

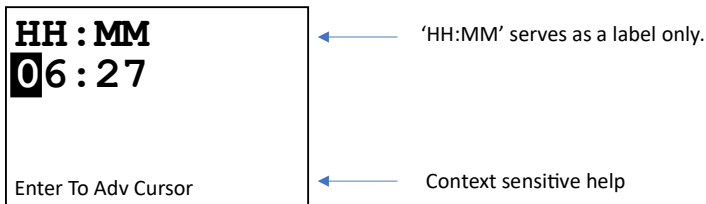

### 4.3.12 Calibration

For transmitters and sensor modules, calibration is done at their respective sensor electronics only trip point settings at the monitor. See transmitter or sensor module manual for calibration instructions. For AMC-3707 and on-board sensors, refer to the below **AMC-3707 CALIBRATION** section for detailed steps.

Sensors naturally degrade over time, losing about 2% of their sensitivity per month. Over time a sensor will start to underreport gas concentrations, meaning that a calibration is necessary to maintain a safe environment.

When the Sensor Module(s) are due for calibration the respective LED will blink CYAN-YELLOW as opposed to its usual GREEN to be able to see at a glance which sensor(s) is(are) overdue.

Information on Calibration Dates (when calibration is due, calibration frequency) can be found in the Sensor Status Screen and UTx Menu.

#### 4.3.12.1 Required Equipment; EZ Cal Exchange Program

[WAITING ON CONTENT CHANGE] [Content is Unique]

#### 4.3.12.2 Required Equipment; On-Site Sensor Module Calibration

For qualified personnel only, the following is recommended for calibration of the various UTx offerings:



Part Number	Gas Type	Recommended Calibration Gas
AMC-UTx-B-91A01-N-R-0000	Carbon Monoxide (CO)	100ppm CO
AMC-UTx-B-91B01-N-R-0000	Carbon Monoxide (CO)	300ppm CO
AMC-UTx-B-98A01-N-R-0000	Nitrogen Dioxide (NO <sub>2</sub> )	10ppm NO <sub>2</sub>
AMC-UTx-B-91A01-98A01-R-0000	Carbon Monoxide (CO) Nitrogen Dioxide (NO <sub>2</sub> )	100ppm CO 10ppm NO <sub>2</sub>
AMC-UTx-B-VCA01-N-R-0000	Carbon Monoxide (CO) Nitrogen Dioxide (NO <sub>2</sub> )	100ppm CO 10ppm NO <sub>2</sub>

**Note:** Calibration gas concentrations above 105ppm CO for 100ppm CO Sensors and 315ppm CO for 300ppm CO Sensors are not supported by the UTx menu. For NO<sub>2</sub> Sensors, calibration gas concentrations greater than 10.6ppm are not supported by the UTx menu.

Please refer to the **UTx Calibration Kit** section for the UTx Calibration Kit that provides the mating adaptor for connecting the calibration gas cylinder to the face of the UTx Sensor Module.

#### 4.3.12.3 Pre Bump Test

Before calibration, a bump test (“as found test”) is usually performed to ensure each sensor is in working order and returning reasonable responses. The bump test involves applying a test gas to the sensor. However, sensor such as CO have a recovery time measured in multiple hours. As a result, the calibration routine would find a zero at a concentration that is not the true background concentration, should the sensor not have a sufficient recovery time.

The “As Found” menu item (see the **Menu Flow Diagrams** section at the end of the manual for the: Sensor Service Menu Flow Diagram) allows the user to enter the measured background concentration before performing a bump test. This value is persisted in memory for 24 hours. If a calibration is performed during this 24h period, the persisted background concentration will be used to negate the effect of the bump test and sensor recovery time on the calibration process.



← Context sensitive help (for the currently highlighted menu item)

Before performing a bump test, navigate to the “As Found” menu and enter the current background reading. The user should then navigate to the main screen so that the gas concentration may be monitored during the bump test. The user may then apply a test gas and monitor the response.



- ← 'Background' serves as a label only.
- ← Edit the current background one digit at a time using the UP/DOWN buttons. Press ENTER to advance the cursor to the next digit. Press ENTER when the last digit is highlighted to save the value.
- ← Context sensitive help

#### 4.3.12.4 Calibration Procedure – Menu

Navigate to the Service Menu and select the sensor to be calibrated. If the **ENTER** button is pressed, then the following menu is shown. This menu is common to all sensors therefore selecting any sensor will produce the same menu.



- ← Context sensitive help (for the currently highlighted menu item)

The **UP** and **DOWN** buttons can be used to navigate the list of service menus for the selected sensor. The sensor's service menu provides the following menu items:

Menu Item	Description
ADAPTiCal	Select this menu item to start calibration for the selected sensor.
As Found	Allows user to enter the background concentration reading before performing a bump test. (Refer to the above <b>Bump Test</b> section for further explanation).
Override	Allows user to override the current sensor value for the selected sensor. (Refer to the below <b>Simulation of Gas Levels</b> section).
Reset	Allows user to trigger a software reset of the selected sensor.
Exit	Select this menu item to return to the main service menu. The current sensor will be selected when the main service menu appears.



- ← Context sensitive help (for the currently highlighted menu item)

With 'ADAPTiCal' highlighted (as above), press **ENTER** to initiate a calibration sequence for the selected sensor. Once initiated, the user will be presented with the following screens in which the background and span level concentrations used for the calibration can be entered:



- ← 'Background' serves as a label only.
- ← Edit the current background one digit at a time using the UP/DOWN buttons. Press ENTER to advance the cursor to the next digit. Press ENTER when the last digit is highlighted to save the value.
- ← Context sensitive help



- ← 'Span Level' serves as a label only.
- ← Edit the span level value one digit at a time using the UP/DOWN buttons. Press ENTER to advance the cursor to the next digit. Press ENTER when the last digit is highlighted to save the value.
- ← Context sensitive help

Once the background and span level gas concentrations are entered, the calibration procedure will start automatically, and the state of the calibration will be displayed on the display as shown below. Throughout the entire calibration procedure, the Abort command remains highlighted therefore the procedure can be aborted at any time by pressing the **ENTER** button.

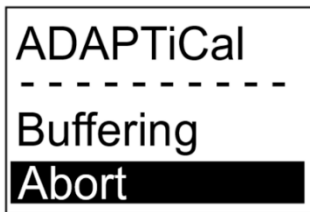

- ← Current state of the calibration procedure
- ← Abort command remains highlighted throughout the entire procedure

During calibration, the procedure will transition through the following set of states:

Menu Item	Description
Buffering	A software register is acquiring data before the gas level can be evaluated.
Find Zero	The gas concentration for 'zero' gas is determined.
Apply Gas	Procedure is ready for the user to apply gas. User will be prompted to be press the <b>ENTER</b> button after the OK command is highlighted in order to indicate when they have applied gas.
Find Gas	Calibration routine will stay in this state until it has detected the full application of gas.
Find Span	Calibration is underway with the specified gas applied. This state will remain active until it either passes or fails.

When the calibration procedure completes its cycle, the result will either be a PASSED or FAILED with calibration results as shown by the following two images.

<p><b>CAL PASSED</b>          Zero Level : 780          Base Level : 800          Span Level : 2700          Orig. Span : 1900          % of Orig. : 100 %          Press Enter to Ack</p>	<p>← Pressing the <b>ENTER</b> button returns the display to the ADAPTiCal menu item</p>
<p><b>CAL FAILED</b>          Zero Level : 781          Base Level : 1058          Span Level : 2956          Orig. Span : 1900          % of Orig. : 100 %          Press Enter to Ack</p>	<p>← When a calibration fails for a sensor that was previously calibrated successfully (e.g. factory calibrated), original span is retained.</p> <p>← Pressing the <b>ENTER</b> button returns the display to the ADAPTiCal menu item</p>

In either case, the OK command is highlighted, therefore, press the **ENTER** button to return to the sensor’s service menu.

**4.3.12.5 Calibration Procedure – Routine**

**Note:** If an “As Found” (Bump Test) is to be performed prior to calibration, first follow the routine outlined in the above **Pre Bump Test** section.

1. To begin calibration, go to the menu, and select the sensor to be calibrate, then select “ADAPTiCal”. Refer to the above **Calibration Menu** section for details.
2. The operator will be asked to provide a background gas concentration. Use the arrow keys to adjust the rightmost digit while pressing enter to commit each digit. Repeat this for all digits.
  - a. It is recommended that prior to calibration to manually set the ventilation system to reduce the background gas concentration to near zero.
  - b. It is recommended to use a trusted secondary measurement device (such as a handheld gas meter) to obtain an accurate reading of the background gas concentration. Enter this value for the background gas concentration when prompted.
  - c. If background gas concentration cannot be reduced to near zero or if the background gas concentration cannot be established, apply pure nitrogen gas to the sensor prior and during the finding zero stage of calibration. Enter 0 for the background gas concentration when prompted.

**CAUTION:**



**In the case of repeated CO Gas Calibrations performed in quick succession (i.e. less than 30 minutes apart) first follow the routine outlined in the ‘PRE BUMP TEST’ section. Then use the Background value provided by the unit during ADAPTiCal startup.**

**A CO sensor element has a tendency to increase its background zero offset after each span gassing. Entering a Background of 0.0 in the second or third attempt can lead to failed calibration.**

3. The operator will then be asked to provide a span level gas concentration (i.e. the concentration of the target gas that is in the cylinder being used to calibrate). Use the arrow keys to adjust the rightmost digit while pressing enter to commit each digit. Repeat this for all digits.
  - a. It is recommended that this concentration be relatively close to the maximum span range of the sensor for best results (as an example, service technicians could use 75ppm gas concentration cylinder for calibrating 100ppm CO Span sensor, however we recommend 100ppm CO).
4. The sensor will enter buffering and the “Find Zero” stage of calibration, assessing the output at the background concentration. When this stage succeeds, the operator will be notified on screen, and the calibration routine will pause until it is acknowledged. Before acknowledging, get the target span gas ready to flow. When **ENTER** is pressed, start applying the gas.
5. The sensor will wait until it detects gas and will enter the “Find Span” stage of calibration. This typically takes between 30 and 180 seconds.
6. Once this stage succeeds, the sensor will check that the result is within limits and notify the operator whether the calibration routine has failed or succeeded. The operator maybe be notified if sensor is nearing end of life.
7. If the calibration fails, the calibration can be attempted again right away, but it is recommended that the operator accepts the background gas concentration provided by the unit since the unit will retain the original background gas concentration.

## 5. Maintenance

### 5.1 General

Maintenance is a crucial activity that should be done at the proper time intervals, which are discussed below.

This product should be cleaned (brushed or wiped) as required, depending on the rate of accumulation of any dust or dirt.

To avoid damage, the unit **MUST NOT** be submerged, hosed, or splashed with any liquids.

### 5.2 Scheduled Calibration

Scheduled calibration is critical in maintaining proper functionality of this product. It is recommended that the Sensor Module(s) be calibrated a minimum of twice a year or more often for demanding applications. Armstrong Monitoring Corporation offers a number of different maintenance plans to suit your requirements. Please see the **Contact Information** section.

### 5.3 Sensor Module

The Sensor Module tracks time since last calibration and will indicate via LED status when service is required. When the Sensor Module can no longer be calibrated, replacement is required; See the **Sensor Module** section for replacement sensor P/N.

#### 5.3.1 Sensor Module Replacement

AMC-SM-xx Sensor Modules are designed to be field replaceable. When changing the sensor module, first ensure that the unit is fully powered down.

##### 5.3.1.1 Remove Sensor Module

1. Detach the IPC Cable from the Sensor Module.
2. Rotate the Sensor Module so the tab aligns as shown in the image below and remove from the Lid Assembly.



### 5.3.1.2 Install Sensor Module

1. Rotate the replacement Sensor Module so the tab aligns as shown.
2. Push and turn clockwise until the Sensor Module is secured.
3. Attach the IPC Cable to the top connector on the Sensor Module.



## 5.4 Verification of Operation

Verification of operation should be performed at least once every 6 months. For highly demanding applications, more frequent verification is recommended.

### 5.4.1 Simulation of Gas Levels

The Monitor Service Menu allows the current gas reading to be overridden by a simulated gas level. This may be useful during system configuration to verify operation of the unit or alarm relays.

If 'Override' is activated from the sensor's service menu, then the display will be updated to show the following sub-menu.

<p><b>Sim Enable</b></p> <p>Sim Gas</p> <p>Exit</p> <p>Edit Sim Enable</p>	<p>← Activate this menu item to edit the simulated gas enable flag for the selected sensor</p> <p>← Activate this menu item to edit the simulated gas concentration for the selected sensor</p> <p>← Activate this menu item to exit the "Override" sub-menu</p> <p>← Context sensitive help (for the currently highlighted menu item)</p>
--	--

If 'Sim Enable' is activated from the 'Override' sub-menu, then the display will be updated to show the following editing screen.

<p><b>Sim Enable</b></p> <p><b>Disabled</b></p> <p>Press Enter to Save</p>	<p>← Defaults to the current value of the Sim Enable flag. Use UP/DOWN arrow buttons to toggle between Disabled and Enabled. Press ENTER button to confirm selection.</p> <p>← Context sensitive help (for the currently highlighted menu item)</p>
--	---

When the **ENTER** button is pressed, the confirmation screen (described previously) is displayed. If Yes is selected, the edit value is persisted as the new value for the Sim Enable Flag. Otherwise, the

edit value is rejected. In either case, the menu returns to the Override sub-menu menu with the ‘Sim Enable’ menu item selected.

### 5.4.2 LED/Relay Activation Test

The Main Service Menu allows the activation of all relays and LEDs, regardless of alarm state. This may be useful during system configuration to verify operation of the LEDs and relays, as well as to verify that the polarity settings are correct.

From the Main Service menu, selecting ‘Test’ will update the display to show the following:

The screenshot shows a rectangular menu box with the following content:

- Top line: **Test**
- Second line: **Disabled** (highlighted with a black background)
- Bottom line: **Press Enter To Save**

Three blue arrows point from the text on the right to the corresponding elements in the menu box:

- Arrow 1 points to 'Test': 'Test' serves as a label only.
- Arrow 2 points to 'Disabled': Defaults to the current value of the test enable flag. Use **UP/DOWN** arrow buttons to toggle between Disabled and Enabled. Press **ENTER** button to confirm selection.
- Arrow 3 points to 'Press Enter To Save': Context sensitive help

When the **ENTER** button is pressed, the confirmation screen (described previously) is displayed.

In addition to activating all relays (taking into account polarity settings), all display LEDs will appear solid white, if functional.

## 6. Troubleshooting

### 6.1 Symptoms and Corrective Actions

Table 6-1: Troubleshooting Table

Symptom	Possible Cause	How to Verify	Corrective Action
Buzzer or Relays not activating.	Bad Connection to Buzzer or Relays.	No continuity between COM and NO Bus Module terminals.	Re-seat wiring connections for buzzer and relay coils.
	Configuration Incorrect	No continuity between Relay coil connections and relay coils.	Check UTx > Buzzer menu parameters. Check if either Alarm or All Levels are selected in item.
			Check UTx > Alarms > Alarm 1/2/3/4 > Output menu parameters; ensure Relays 1 and 2 are checked (enabled).
			The Relay 1 coil is energized during the WARN state, while the Relay 2 coil is energized during the ALARM state.
			Alarm 1 is used to control Relay 1 for channel 1. Alarm 2 is used to control Relay 2 for channel 1.
Unable to enter ADAPTiCal menu item.	Sensor in warm-up due to power on or recovering post-calibration attempt.	Alarm LED is white. Sensor module in warm-up also has white LED.	Warm-up period will last a maximum of 300 seconds. Display will indicate countdown. ADAPTiCal is not operational/accessible until countdown has finished.
	Temperature Sensor Failure.	Alarm LED is green.	Contact Armstrong Monitoring for technical support.



## 7. Sensor Module Default Settings

### 7.1 Default Alarm Settings

Table 7-1: Default Alarm Settings

SM Code	Short Gas Name	Long Gas Name	Set Point 1	Set Point 2	Set Point 3	Engineering Units
			Increasing	Increasing	Increasing	
91A	CO	Carbon Monoxide	25	100	100	PPM
VCA	CO	Carbon Monoxide	25	100	100	PPM
	NO <sub>2</sub>	Nitrogen Dioxide	1	3	3	PPM

### 7.2 Default Sensor Module Settings

Table 7-2: Default Sensor Module Settings

SM Code	Short Gas Name	Long Gas Name	Span	Hysteresis	Zero Blanking	Engineering Units
91A	CO	Carbon Monoxide	100	2.50	+/- 5.0	PPM
VCA	CO	Carbon Monoxide	100	2.50	+/- 5.0	PPM
	NO <sub>2</sub>	Nitrogen Dioxide	10	0.25	+/- 0.5	PPM

## 8. Menu Flow Diagrams

### 8.1 Main Screen / Password Flow

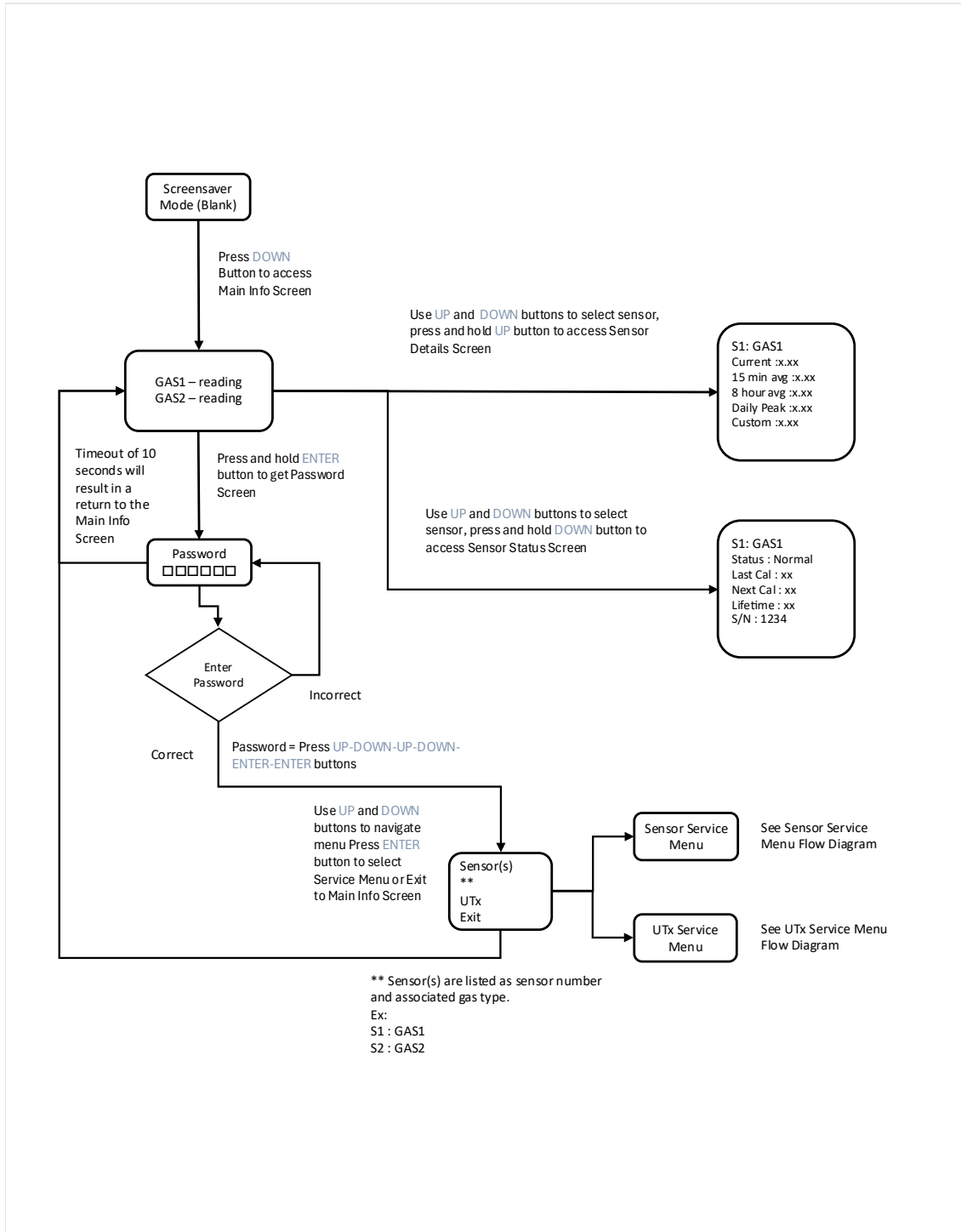

Figure 8-1: Main Screen / Password Flow

## 8.2 UTx Service Menu

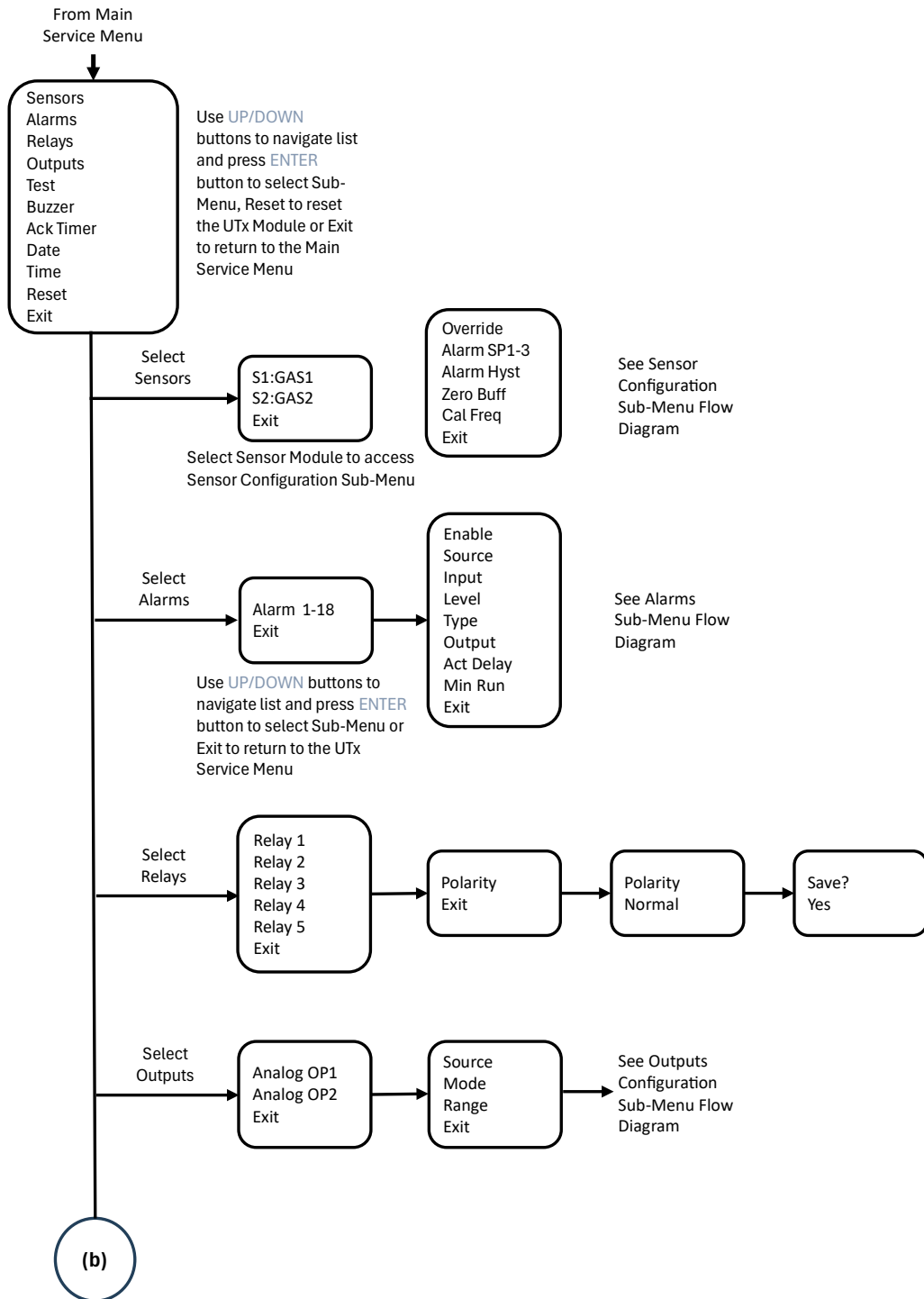

Figure 8-2: UTx Service Menu (a)

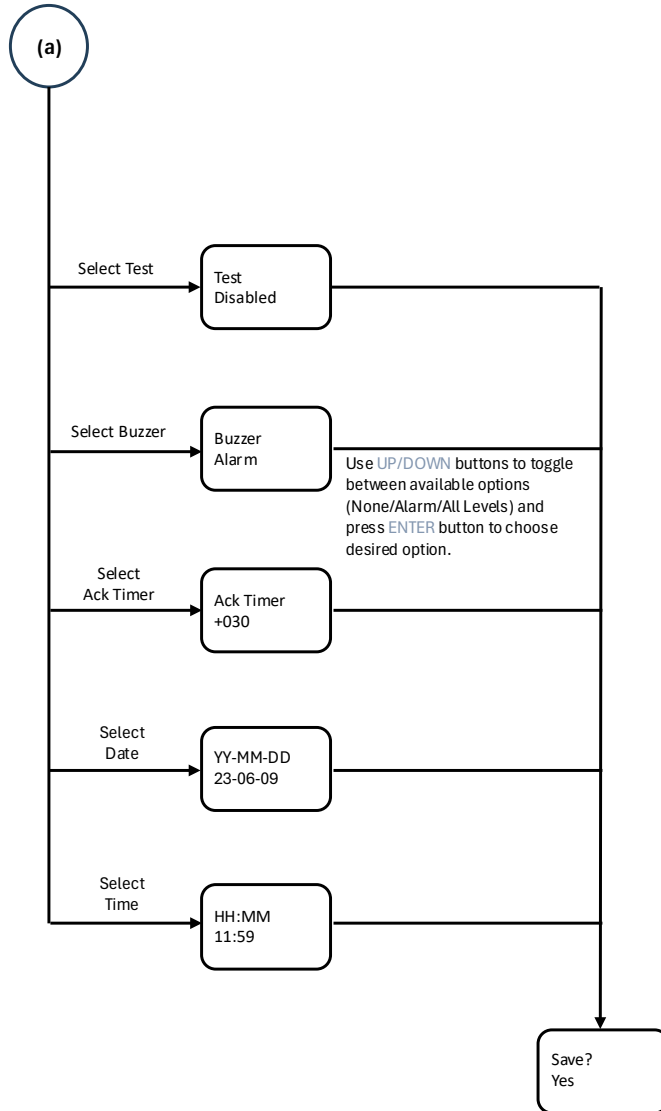

Figure 8-3: UTx Service Menu (b)

### 8.3 Sensor Service Menu

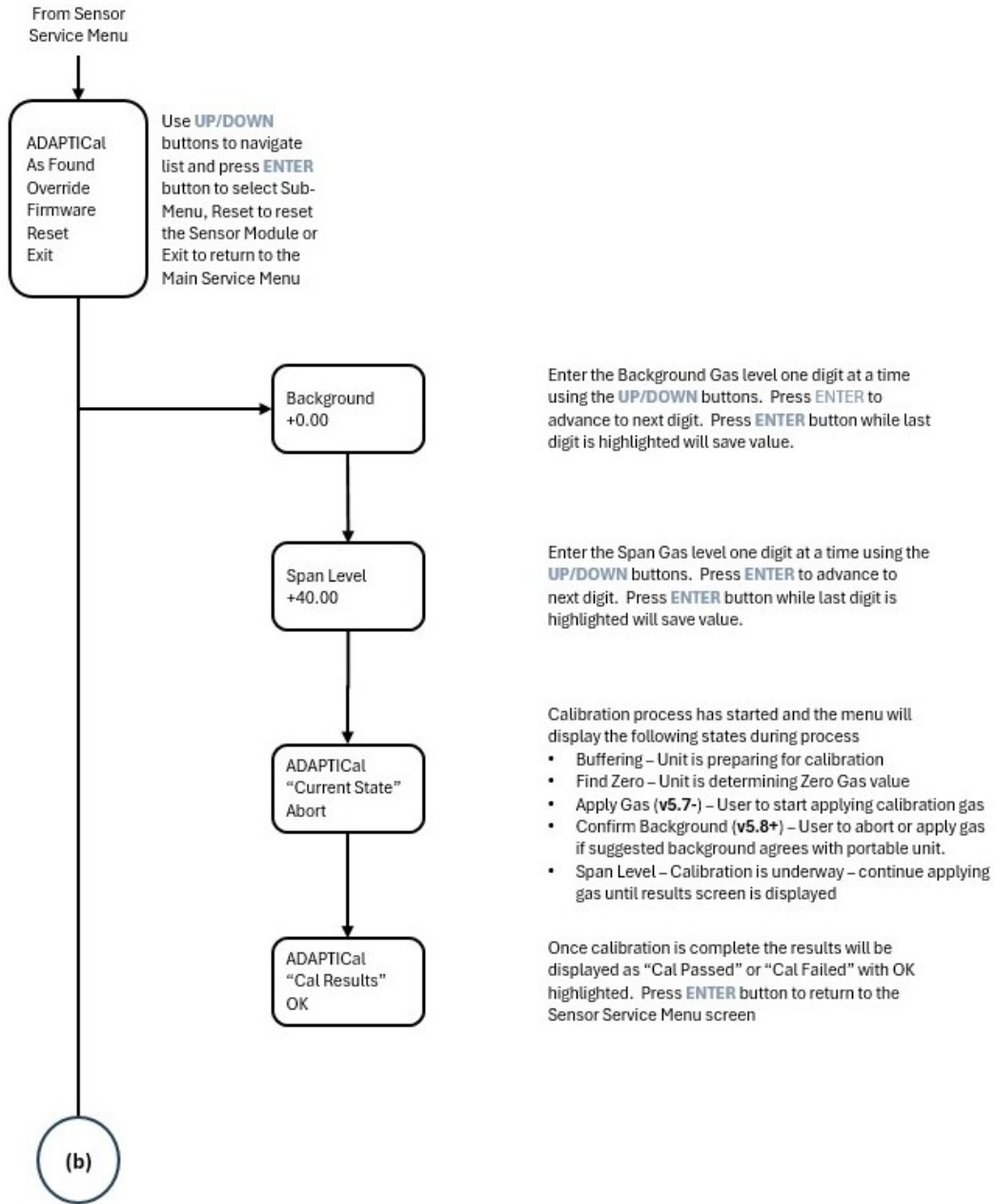
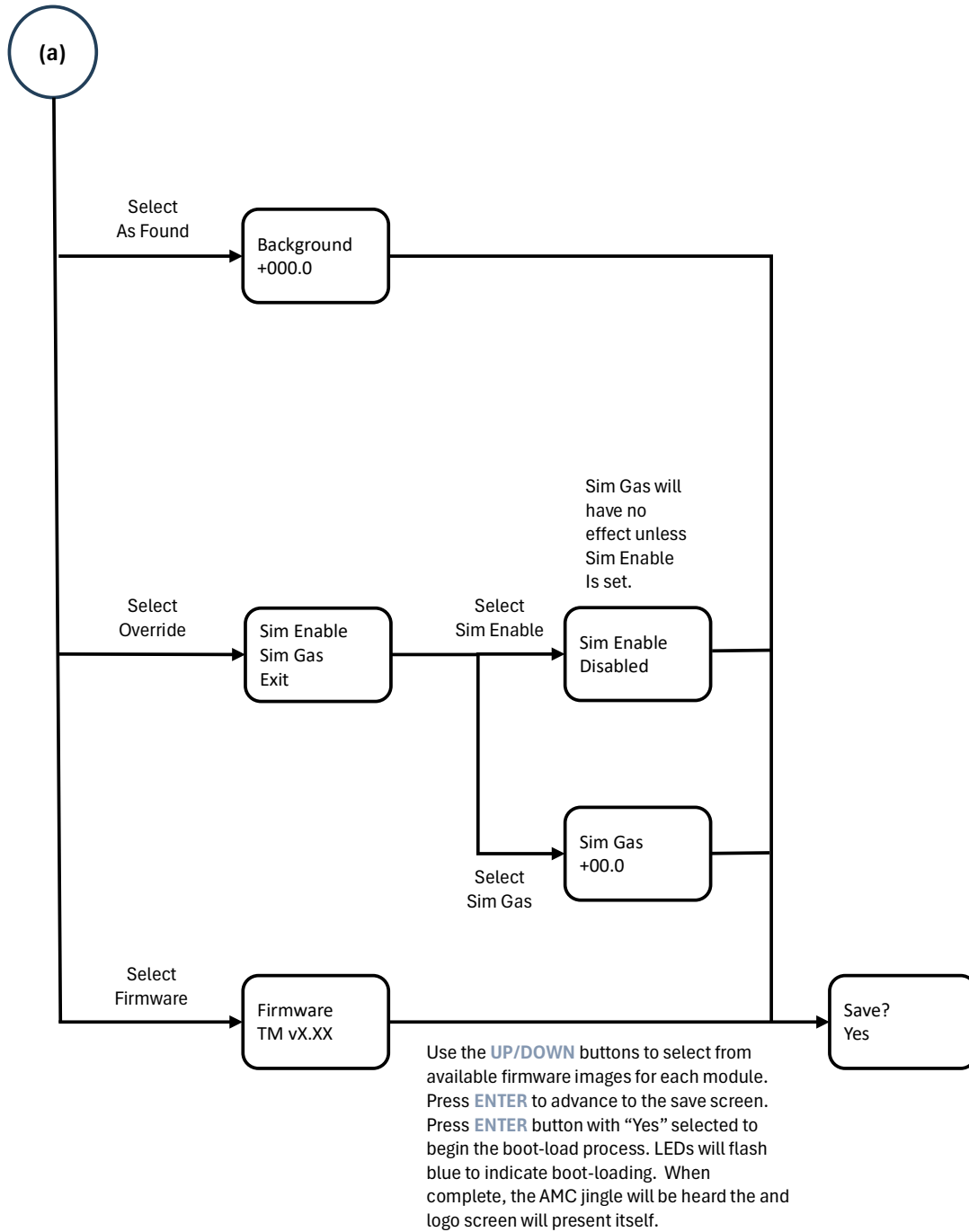

Figure 8-4: Sensor Service Menu Diagram (a)



**Figure 8-5: Sensor Service Menu Diagram (b)**

## 8.4 Sensor Configuration

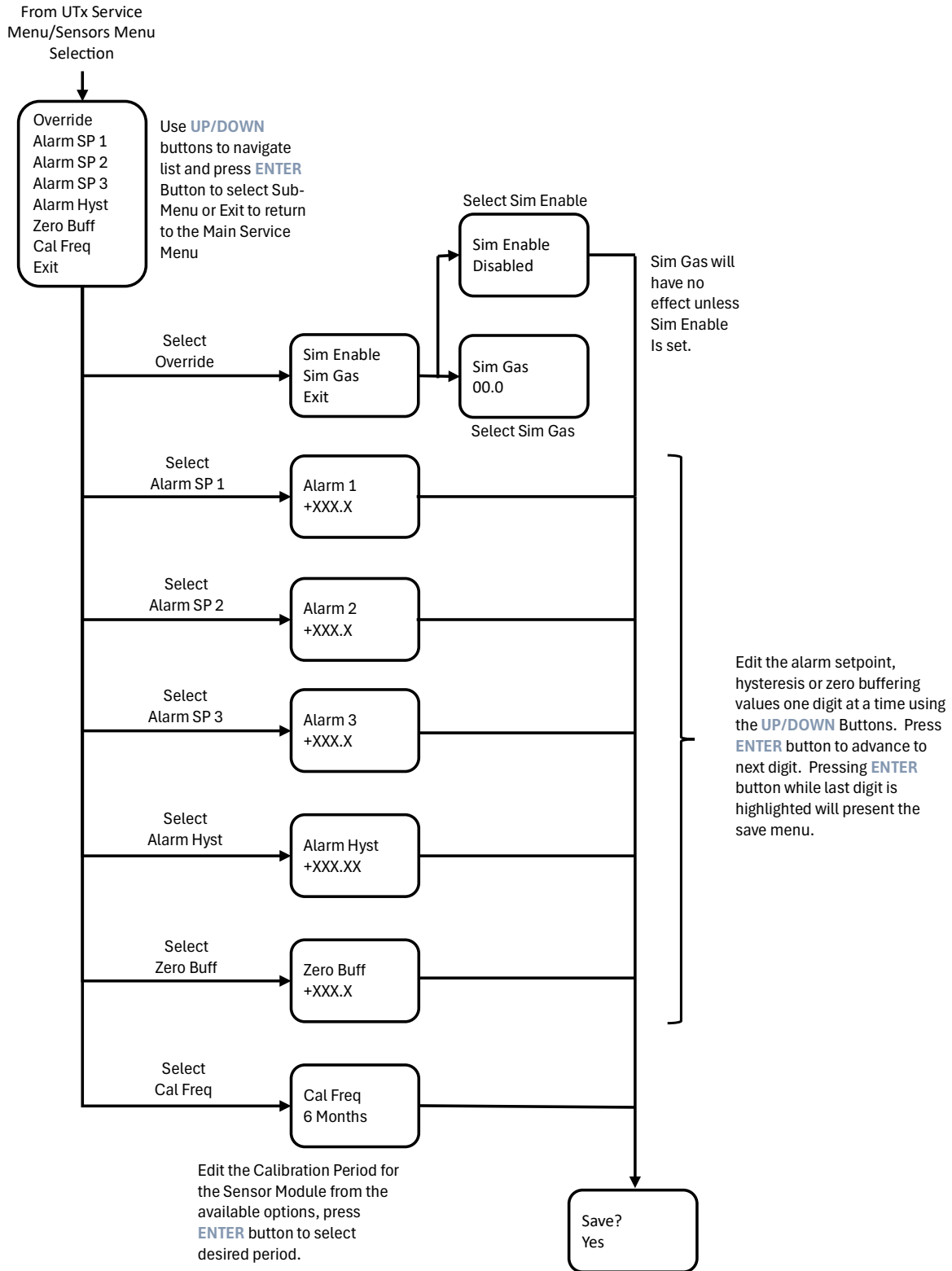

Figure 8-6: Sensor Configuration Menu Flow Diagram

## 8.5 Alarm Menu

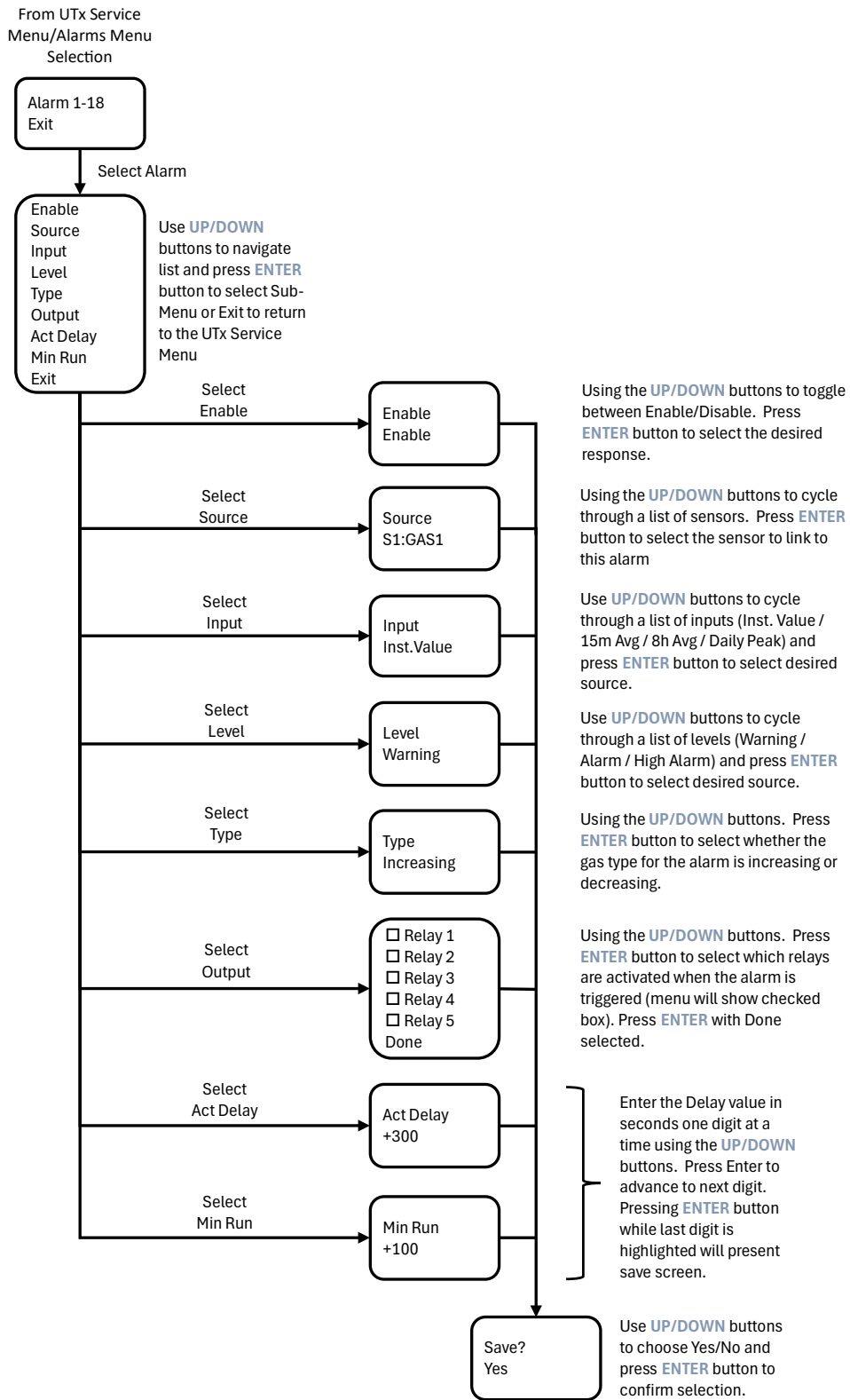

Figure 8-7: Alarm Menu Flow Diagram

## 8.6 Outputs

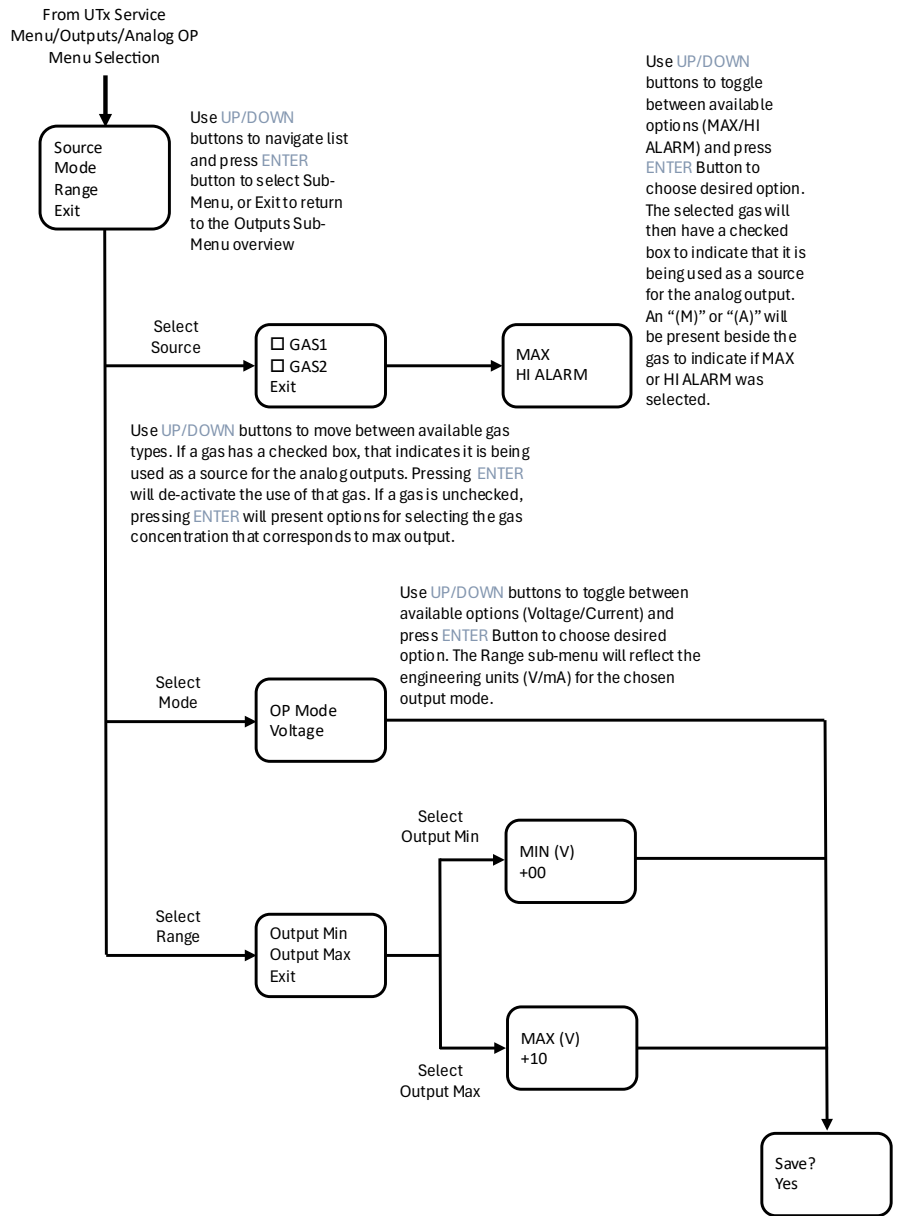

Figure 8-8: Outputs Menu Flow Diagram



## 9. Revision History

### 9.1 Document Revision History

Table 9-1: Document Revision History

Revision	Release Date	Change Description	Affected Section(s)
A	December 2025	Initial Release	
B	December 2025	Custom window option removed.	Transmitter Service Menu – Alarm Sub-Menu Calibration Procedure - Menu
		Correction to timeout duration from 30s to 300s.	Detailed Sensor Screen Detailed Status Screen
		Addition of “Quick Info” section.	Menu Overview
		Addition of alternative “Override”.	Sensor Alarm Configuration Sub-Menu
		Image and verbiage updated to be more generic.	Transmitter Service Menu – Alarm Sub-Menu - Output
C	March 2026	Corrections to diagrams.	Menu Flow Diagrams