



1011/1012

AMC-1011/1012 ONE/TWO CHANNEL HAZARDOUS GAS MONITOR INSTRUCTION MANUAL

IMPORTANT:

**PLEASE READ THESE INSTRUCTIONS
CAREFULLY BEFORE BEGINNING
INSTALLATION AND/OR OPERATION OF
THIS EQUIPMENT.**

Filename: Manual_amc1011-1012

Revised 01/26/2000
Copyright © 01/1989

The Armstrong Monitoring Corporation
(613) 225-9531 — ①
(613) 225-6965 — Fax
(800) 465-5777 — ① U.S. Toll Free
www.armstrongmonitoring.com



AMC-1011/1012

TABLE OF CONTENTS

	Page
TABLE OF CONTENTS.....	III
WARRANTY.....	IV
LIABILITY.....	IV
MODIFICATIONS AND SUBSTITUTIONS.....	IV
PRODUCT RETURN UNDER WARRANTY.....	IV
SPECIFICATIONS.....	V
1 INTRODUCTION.....	1
1.1.1 MAIN FEATURES.....	1
1.1.2 INDIVIDUAL CHANNEL FEATURES.....	1
Figure 1.1 AMC-1011/1012 MONITOR, FRONT PANEL.....	2
Figure 1.2 INDIVIDUAL CHANNEL, FRONT PANEL.....	3
Figure 1.3 AMC-1011/1012 MONITOR, INSIDE PANEL.....	4
2 INSTALLATION.....	5
2.1 LOCATION AND MOUNTING.....	5
2.2 WIRING OF THE MONITOR, TRANSMITTER(S) AND RECORDER(S).....	5
Figure 2.1 AMC-1011/1012 MONITOR MOUNTING DIMENSIONS.....	6
Figure 2.2 POWER SUPPLY, TRANSMITTER AND RECORDER CONNECTIONS.....	7
Figure 2.3 RELAY WIRING DIAGRAM, SHOWING THE CONTACT ARRANGEMENT FOR THE NON-ALARM CONDITION.....	8
3 OPERATION AND CALIBRATION.....	9
3.1 OPERATION OF THE MONITOR.....	9
3.2 OPERATION OF INDIVIDUAL CHANNELS.....	9
3.2.1 DISPLAYS AND CONTROLS.....	9
3.2.2 ALARM LEVELS.....	10
3.2.3 FAIL CONDITION FEATURE.....	10
3.3 CALIBRATION.....	10
4 MAINTENANCE.....	11
4.1 GENERAL.....	11
4.2 VERIFICATION OF OPERATION.....	11
4.3 SENSOR REPLACEMENT.....	11



AMC-1011/1012

WARRANTY

The AMC-1011/1012 gas monitor is warranted against defects in material and workmanship for a period of two years from date of delivery. During the warranty period, we will repair or replace components that prove to be defective in the opinion of the Armstrong Monitoring Corporation. We are not liable for auxiliary interfaced equipment, nor consequential damage.

NOTE:

ANY SUBSTITUTION OR TAMPERING WITH COMPONENTS WITHOUT THE EXPRESS PERMISSION OF THE ARMSTRONG MONITORING CORPORATION MAY RESULT IN DAMAGE THAT MAY CANCEL THE EFFECTIVENESS OF THE WARRANTY.

LIABILITY

All Armstrong Monitoring Systems must be installed and maintained according to instructions. Only qualified technicians should install and maintain the equipment.

The Armstrong Monitoring Corporation shall not be responsible for any liability arising from auxiliary interfaced equipment, consequential damage, or the installation and operation of this equipment. Armstrong's total liability is contained in the warranty conditions stipulated above. No other acceptance of liability is expressed or implied by the Armstrong Monitoring Corporation.

Read this manual carefully, as the purchaser is entirely responsible for installation and operation.

MODIFICATIONS AND SUBSTITUTIONS

Due to an ongoing development program, Armstrong reserves the right to modify the design and substitute components in any of its products without prior notice. All changes are at the sole discretion of Armstrong, and Armstrong shall not be liable for any costs arising out of such modifications or substitutions, which may be incurred by the user.

PRODUCT RETURN UNDER WARRANTY

All products that must be returned for warranty service will be by prepaid freight and they will only be accepted with an R.M.A. number issued by The ARMSTRONG MONITORING CORPORATION. Goods returned to the client will be freight collect.



AMC-1011/1012

SPECIFICATIONS

Monitor Serial Number.....

Power Supply Requirement..... 120 VAC, 60 Hz

Operating Temperature Range..... 0°C to 40° C

Chan. No.	Transmitters			Alarm Trip Points	
	Pt. No.	Ser. No.	Gas Type	Low	High
1					
2					

Chan. No.	Relays				Alarm Type		Audio Alarm Condition		
	Low Fail	High Fail	High Low	High Low Fail	Latching	Non-Latching	Low	High	Fail
1									
2									

NOTE:

FOR ADDITIONAL SPECIFICATIONS, REFER TO TRANSMITTER MANUAL.

NOTE:

ALL ARMSTRONG MONITORING SYSTEMS MUST BE INSTALLED AND MAINTAINED ACCORDING TO INSTRUCTIONS, TO ASSURE PROPER OPERATION. ONLY QUALIFIED TECHNICIANS SHOULD INSTALL AND MAINTAIN THE EQUIPMENT.



AMC-1011/1012

1 INTRODUCTION

1.1 GENERAL DESCRIPTION

The AMC-1011/1012 is a one/two channel gas monitoring system with remote transmitter/sensor unit(s) designed to continuously monitor surrounding air for traces of hazardous gases (see Specifications, PAGE V). It can be factory configured to detect a wide variety of gases, depending on which transmitter/sensor units are used. The monitor comes with the following features, as shown in Figures 1-1, 1-2, and 1-3:

1.1.1 MAIN FEATURES

The following, lists all the main features of the AMC-1011/1012 gas monitoring system.

1. TRANSMITTER (S) -Long life solid state, factory calibrated, remote calibration feature. (One per channel).
2. POWER SWITCH -Main AC on/off switch for all channels.
3. FUSE HOLDER -Front panel mounted for easy access to the fuse (type 3AG, 2 Amp).
4. AUDIO ALARM INDICATOR -The buzzer will activate when an alarm condition occurs (see Specifications, PAGE V).
5. CLAMPS -To secure the front panel, restricting access to internal controls.
6. POWER TERMINAL BLOCK -For line voltage connections (120 VAC, 60 Hz.).
7. TRANSFORMER -Main power transformer for the system.
- 8.

1.1.2 INDIVIDUAL CHANNEL FEATURES

The following, lists the features for one channel of the AMC1011/1012 gas monitoring system. Each channel is identical.

1. CHANNEL POWER SWITCH -On/off switch for each channel.
2. ON/FAIL INDICATOR -Power is indicated by a green LED. When a fail condition occurs, the LED will flash.
3. ANALOG METER DISPLAY -Panel meter to show concentration of gas.
4. ZERO ADJUST -Sets the zero point of the display.
5. SPAN ADJUST -Sets the full-scale range of the display.
6. HI/LO ALARM SWITCH -Used to display the high and low alarm trip points.
7. HIGH ALARM ADJUST -Sets the high alarm trip point.
8. LOW ALARM ADJUST -Sets the low alarm trip point.
9. HIGH ALARM INDICATOR -High levels of gas are indicated by a red LED.
10. LOW ALARM INDICATOR -Low levels of gas are indicated by a yellow LED.
11. TEST/RESET SWITCH -The test function is provided to electronically simulate alarms in order to test the low and high alarm indicators, the relays and the audio alarm indicator. The reset function is provided to turn off an alarm when latching relays are used.
12. TERMINAL BLOCK -Provides connection points for a transmitter, relay contacts and a recording device.
13. AMC-10101 P.C.BOARD -Contains the relays and logic circuits to operate one channel of the system.



AMC-1011/1012

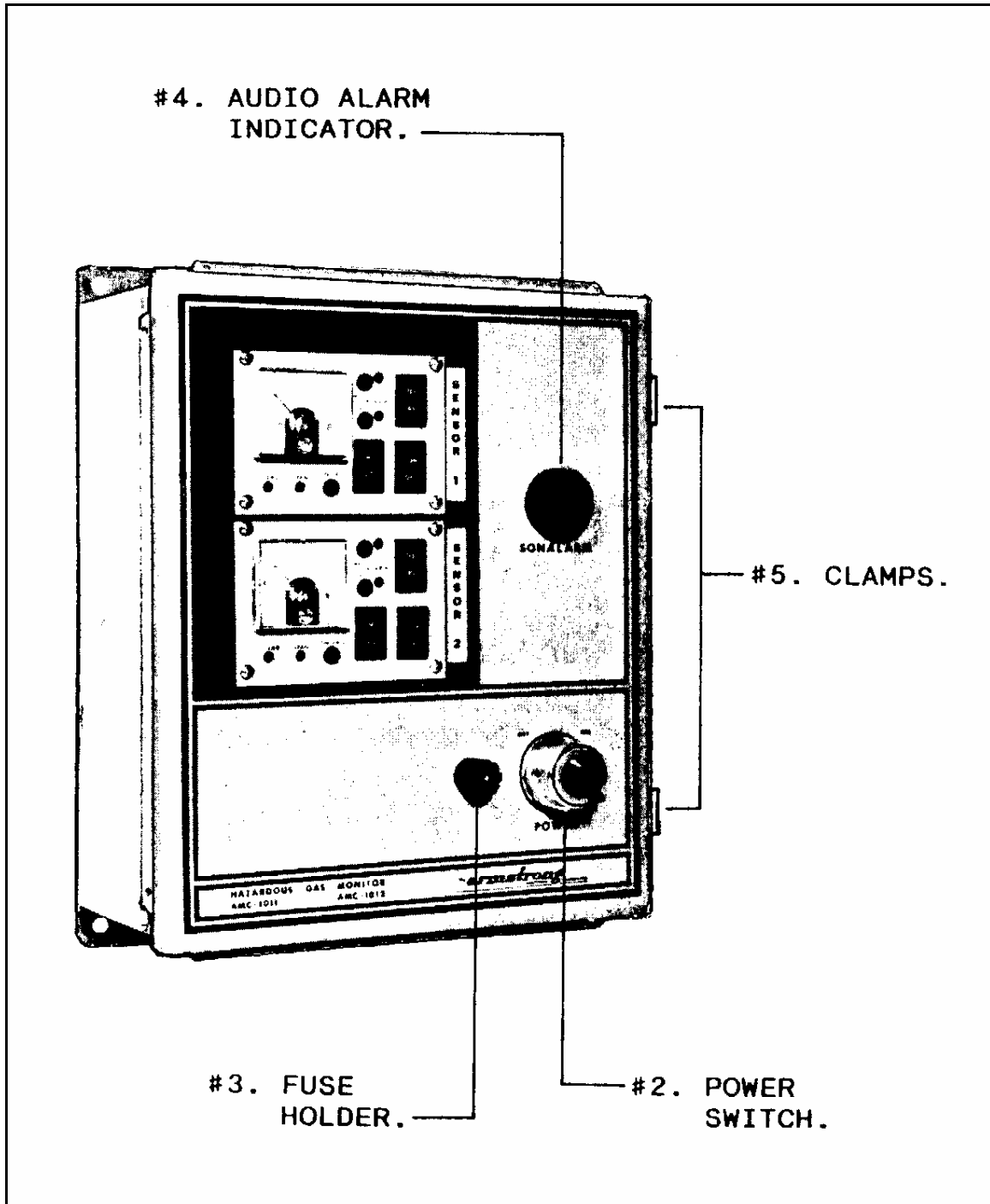

FIGURE 1.1 AMC-1011/1012 MONITOR, FRONT PANEL



AMC-1011/1012

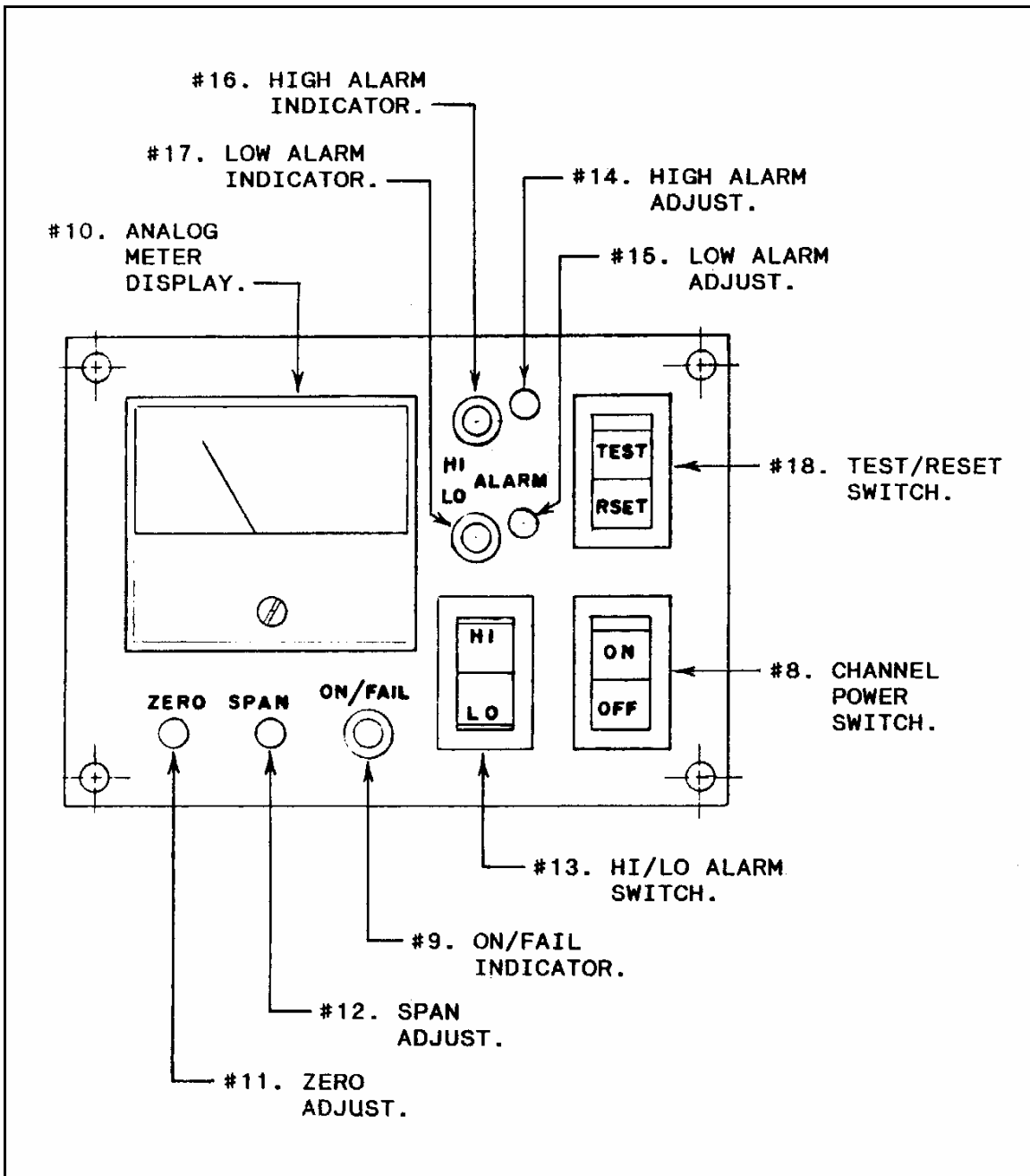

FIGURE 1.2 INDIVIDUAL CHANNEL, FRONT PANEL



AMC-1011/1012

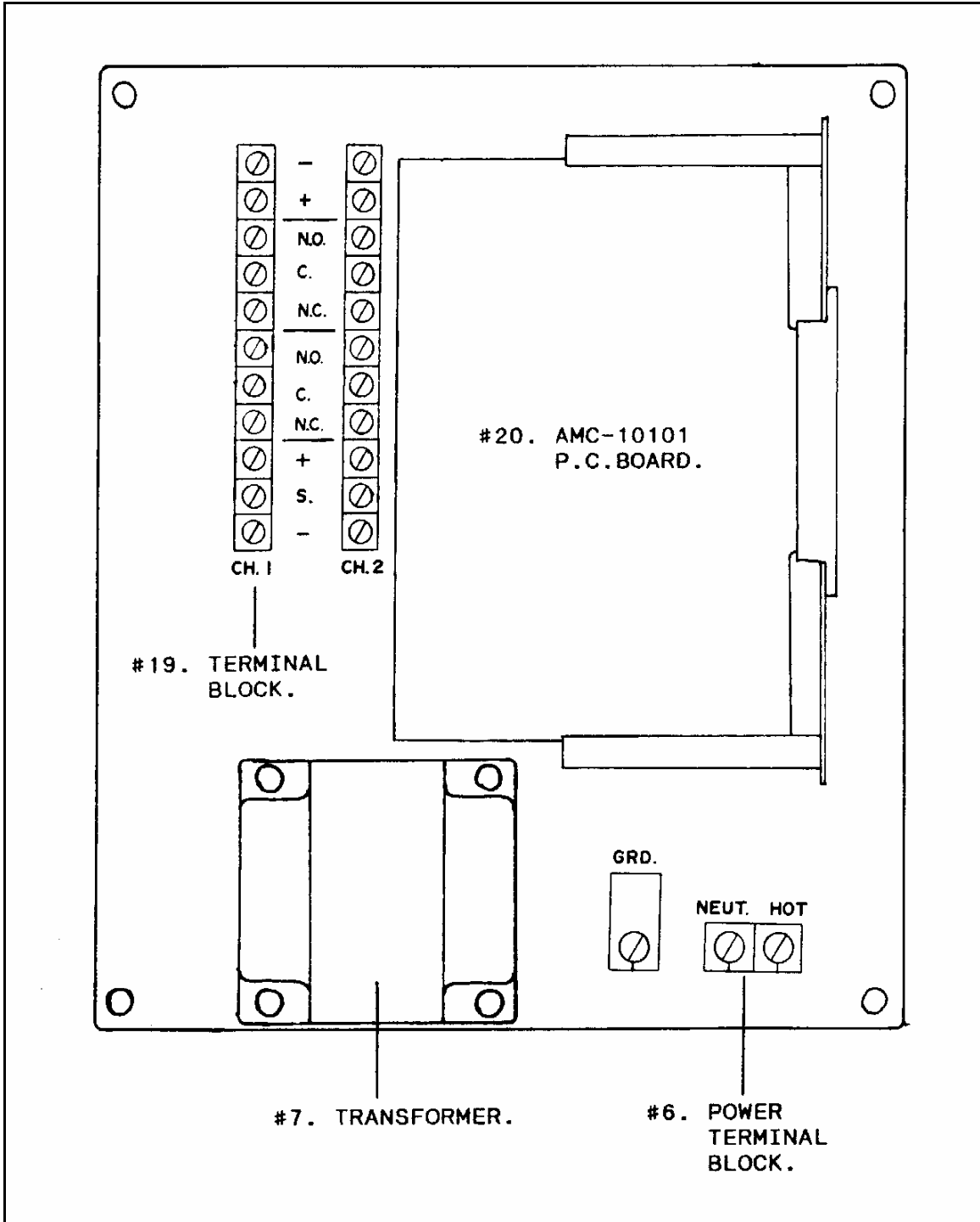

FIGURE 1.3 AMC-1011/1012 MONITOR, INSIDE PANEL



AMC-1011/1012

2 INSTALLATION

2.1 LOCATION AND MOUNTING

Care should be taken to securely fasten the monitor (via four five-sixteenth inch diameter holes provided) to a solid, vertical, non-vibrating surface or structure at eye level height. See Figure 2-1 for mounting dimensions.

Mount the monitor in a NON-HAZARDOUS area (e.g. control room, manager's office) where the unit can be observed periodically. Three knockouts are supplied at the bottom of the enclosure for connecting half-inch conduit. One opening is used for AC power, one for sensor wiring and the other may be used for relay circuits.

Refer to the transmitter manual (Section 2.1 and Figure 2-1) for location and mounting of the transmitter/sensor unit(s).

2.2 WIRING OF THE MONITOR, TRANSMITTER(S) AND RECORDER(S)

NOTE:

BEFORE MAKING ANY CONNECTIONS, MAKE SURE THAT THE MAIN POWER SOURCE IS OFF, AND THAT THE POWER SWITCH ON THE FRONT PANEL OF THE MONITOR IS IN THE OFF POSITION.

- | | |
|--------------|-------------------------------------------------------------------------------------------------------------------------------------------------------------------------------------------------------------------------------------------------------------------------------------------------------------------------------------------------------------|
| Power Supply | -The monitor operates on 120 VAC, 60 HZ. The power supply connections are made at the power terminal block located inside the monitor (see Figure 2-2). |
| Relays | -There are two or three SPDT relays (see Specifications, PAGE V) on each AMC-10101 logic board in the monitor. The relay contacts are available for activating a remote alarm and/or, in some applications, an exhaust fan. Relays are rated 1 Amp. @ 28 VDC, 0.5 Amp @ 120 VAC, resistive. See Figure 2-3 for relay contact arrangement on terminal block. |
| Transmitter | -Each transmitter (one per channel) connects to the (-,sig,+) connections on a channel terminal block, located on the inside panel of the monitor (see Figure 2-2). Connections should be made using shielded cable. Refer to the transmitter manual (Section 2.2, Figures 2-2 and 2-3) for cable selection and wiring. |
| Recorder | -A recording device, such as a chart recorder or a datalogger can be connected to the terminal block REC (-,+) connections as shown in Figure 2-2. |



AMC-1011/1012

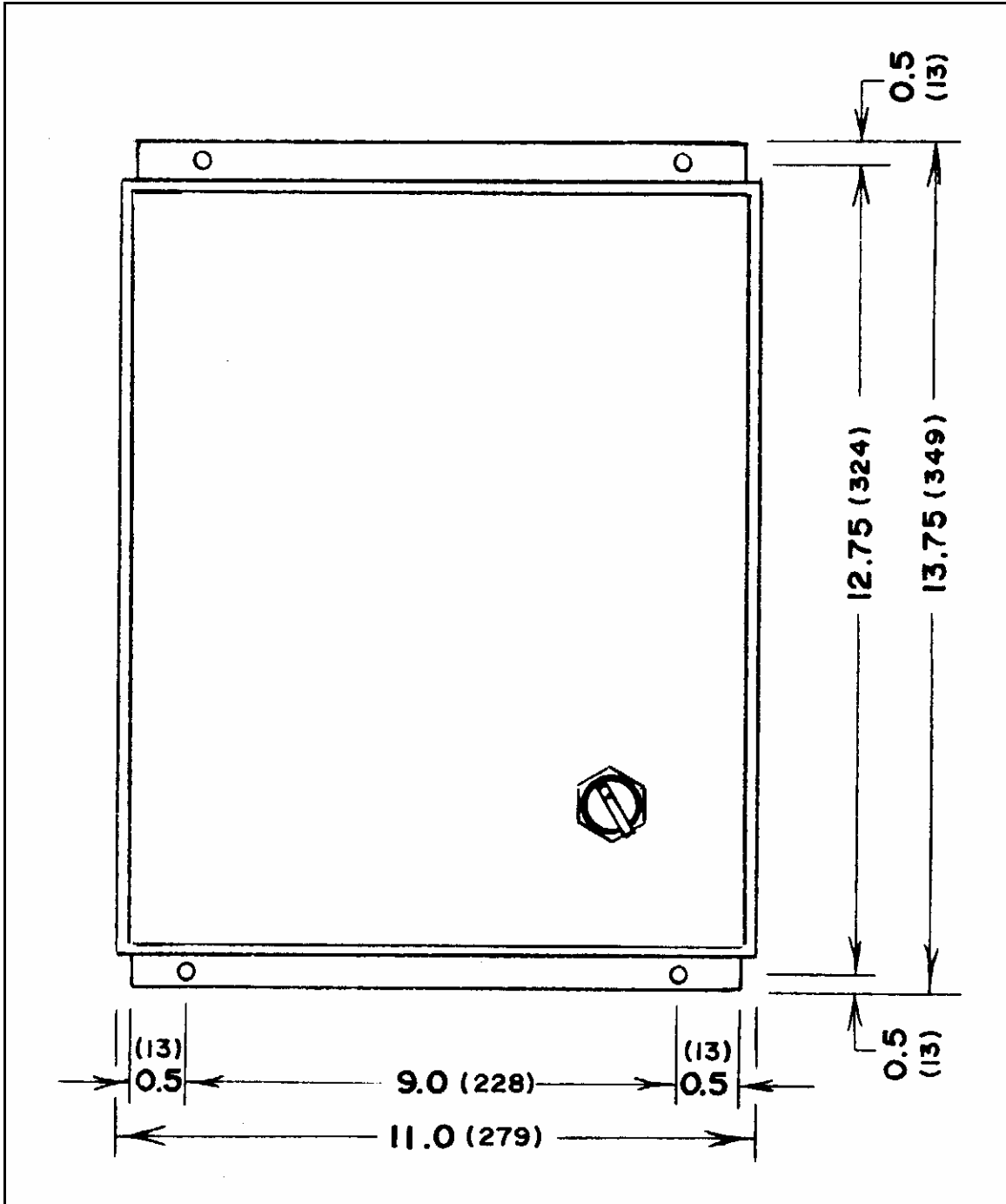

FIGURE 2.1 AMC-1011/1012 MONITOR MOUNTING DIMENSIONS



AMC-1011/1012

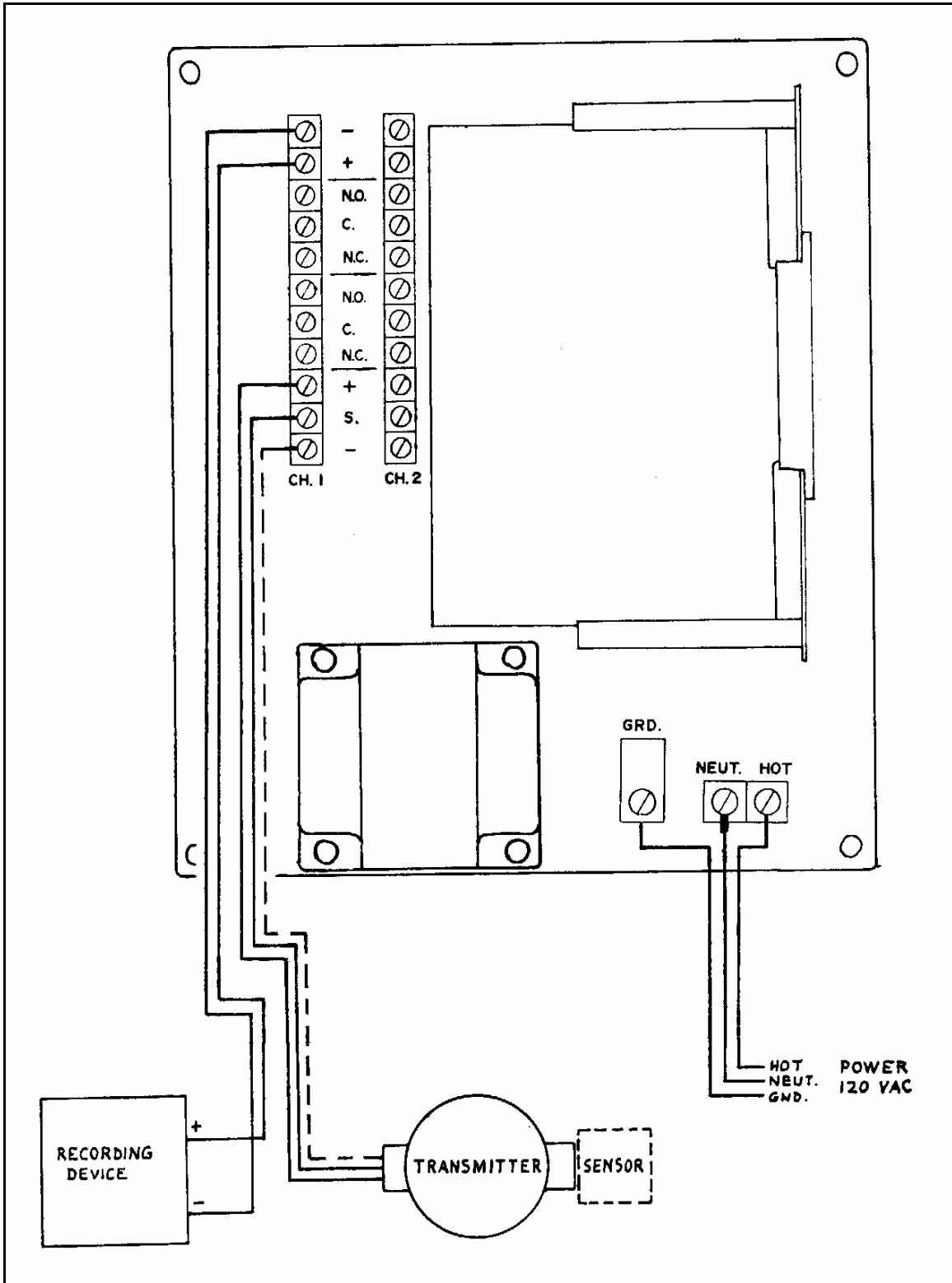

FIGURE 2.2 POWER SUPPLY, TRANSMITTER AND RECORDER CONNECTIONS



AMC-1011/1012

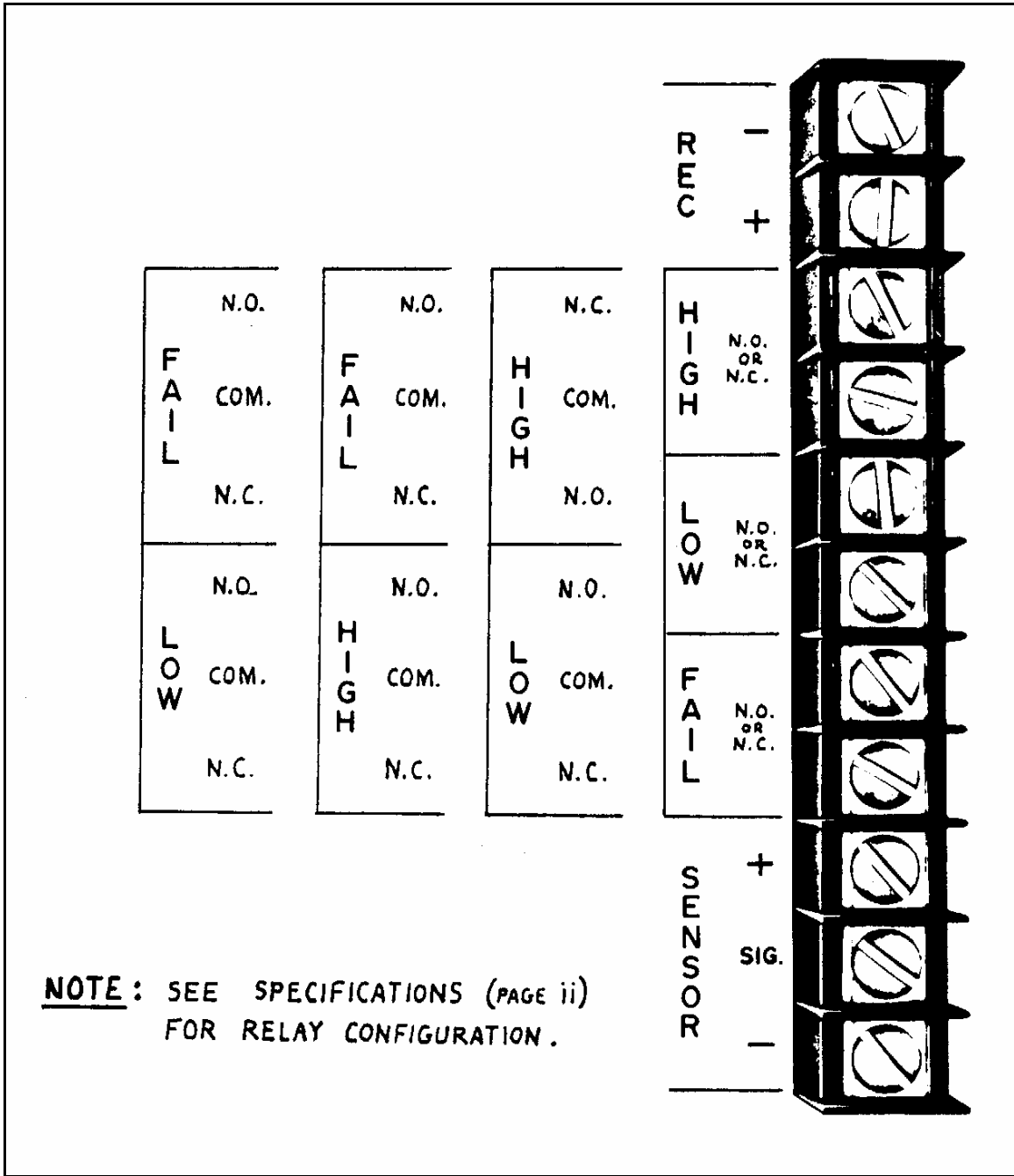

FIGURE 2.3 RELAY WIRING DIAGRAM, SHOWING THE CONTACT ARRANGEMENT FOR THE NON-ALARM CONDITION



AMC-1011/1012

3 OPERATION AND CALIBRATION

3.1 OPERATION OF THE MONITOR

NOTE:

BEFORE TURNING ON THE MAIN POWER SUPPLY TO THE MONITOR, MAKE SURE ALL CONNECTIONS ARE PROPERLY MADE.

The following procedure should be used to power-up the system. Refer to Figures 1-1 and 1-2 for locations of controls.

1. Make sure that the main power switch and individual channel power switches on the monitor are in the OFF position.
2. Turn ON the main power supply for the monitor.
3. Turn ON the main power switch on the front panel of the monitor.
4. Turn ON all the individual channel power switches.

When power is applied, the green on/fail LEDs will light and a 30 second time delay eliminates false alarms from occurring during the initial warm-up period. After this delay, the monitor becomes fully operational. Sensors require a longer warm-up period to stabilize (refer to the transmitter manual, Section 3.1).

3.2 OPERATION OF INDIVIDUAL CHANNELS

During power-up operation, upscale meter readings may occur. A built-in delay disables all alarm conditions for a period of approximately 30 seconds.

3.2.1 DISPLAYS AND CONTROLS

After the unit is operational, if the transmitter/sensor unit detects any gas, the concentration of gas will be displayed on the meter.

The test switch is used to electronically simulate alarms in order to test the low and/or high alarm indicators, the meter, the relays and the audio alarm indicator. However, the test switch will not function unless a transmitter/sensor unit is connected.

NOTE

FOR THE FOLLOWING ALARM LEVELS AND FAIL CONDITION, REFER TO THE SPECIFICATIONS (PAGE V) FOR CONFIGURATION OF RELAYS AND AUDIO ALARM INDICATOR (BUZZER).



AMC-1011/1012

3.2.2 ALARM LEVELS

Normally, if any gas surrounding a sensor exceeds the low alarm trip point setting, the yellow LED and low alarm relay for that channel will be activated. Likewise, if any gas exceeds the high alarm trip point setting, the red LED, high alarm relay and buzzer will be activated.

Should only one of the two alarms (high or low) be needed, the unused alarm can be disabled by setting the alarm trip point higher than the full scale range of the meter. The HI/LO alarm switch can be used to display the alarm levels.

There are two types of alarm systems, latching and non-latching (refer to Specifications, PAGE V, for configuration). An alarm is activated when the gas concentration exceeds the trip point level. However, when the concentration of gas falls below the trip point setting, the non-latching alarm will turn off, whereas the latching alarm will remain on until the reset switch is depressed.

3.2.3 FAIL CONDITION FEATURE

A fail alarm will occur when there is an incomplete circuit to the transmitter/sensor unit or when a transmitter's signal is unusually low. When a fail condition occurs, the green ON/FAIL LED and the buzzer will pulse and the fail relay will de-energize, for that channel. To stop the fail alarm, turn OFF the channel power switch.

3.3 CALIBRATION

The AMC-1011/1012 gas monitor is factory calibrated at levels based on set standards. Calibration of the monitor should last for the life of the unit without any need for periodic adjustments, unless the alarm trip point settings need to be changed. The monitor operates with remote transmitter/sensor assemblies and all on-site adjustments are made at the transmitter(s) and NOT at the monitor.

Refer to the transmitter manual (Section 3.2 and Figure 3-1) for information on the transmitter calibration procedure.

NOTE:

BEFORE MAKING ANY CHANGES TO ALARM LEVEL SETTINGS WE RECOMMEND CONSULTING THE ARMSTRONG MONITORING CORPORATION FOR ADVICE ON SETTING THE PROPER TRIP POINT FOR A SPECIFIC ALARM CHANGE.



AMC-1011/1012

4 MAINTENANCE

4.1 GENERAL

The monitor and remote transmitter/sensor units should be wiped clean with a damp cloth following a regular maintenance program. Avoid spraying, submersion and other conditions that could cause a liquid to enter the monitor, transmitter or sensor and cause possible intrinsic damage to internal components.

4.2 VERIFICATION OF OPERATION

To verify the operation of the monitor and transmitter/sensor units, make sure that they are responding to gas. This test should be performed regularly, every 3 months, but for more demanding applications, verification should be performed on a weekly basis.

4.3 SENSOR REPLACEMENT

CAUTION:

TURN OFF POWER SUPPLY BEFORE ATTEMPTING THE FOLLOWING.

Refer to the transmitter manual (Section 4.3 and Figure 4-1) for information on the sensor replacement procedure and sensor stabilization period, then follow instructions in calibration Section (3.2) of transmitter manual.



AMC-1011/1014 SUPPLEMENT

BATTERY BACK-UP SYSTEM

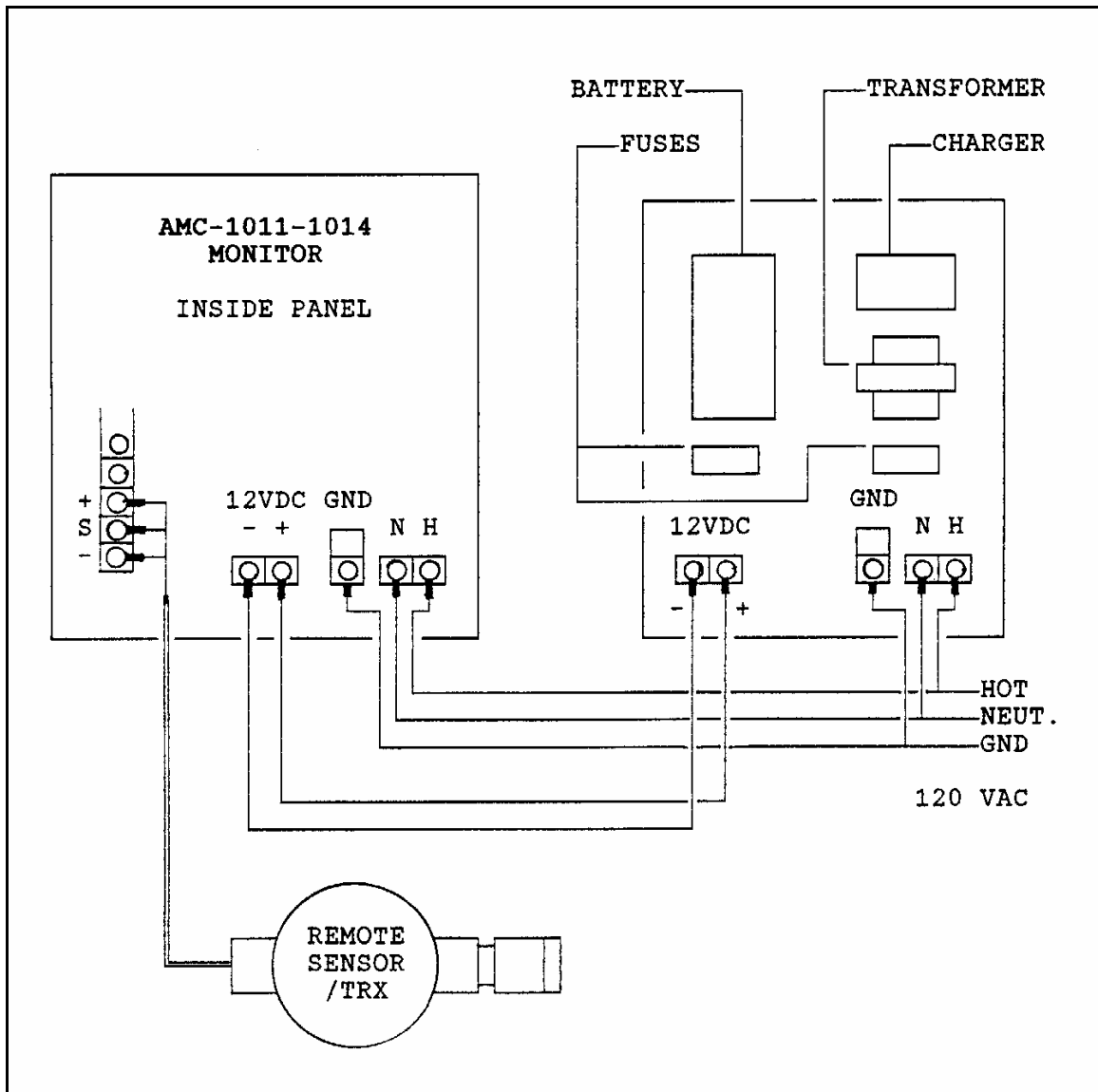

FIELD WIRING LAYOUT FOR AMC-1011/1014 MONITOR WITH BATTERY BACKUP FUNCTION